

Badische Landesbibliothek Karlsruhe

Digitale Sammlung der Badischen Landesbibliothek Karlsruhe

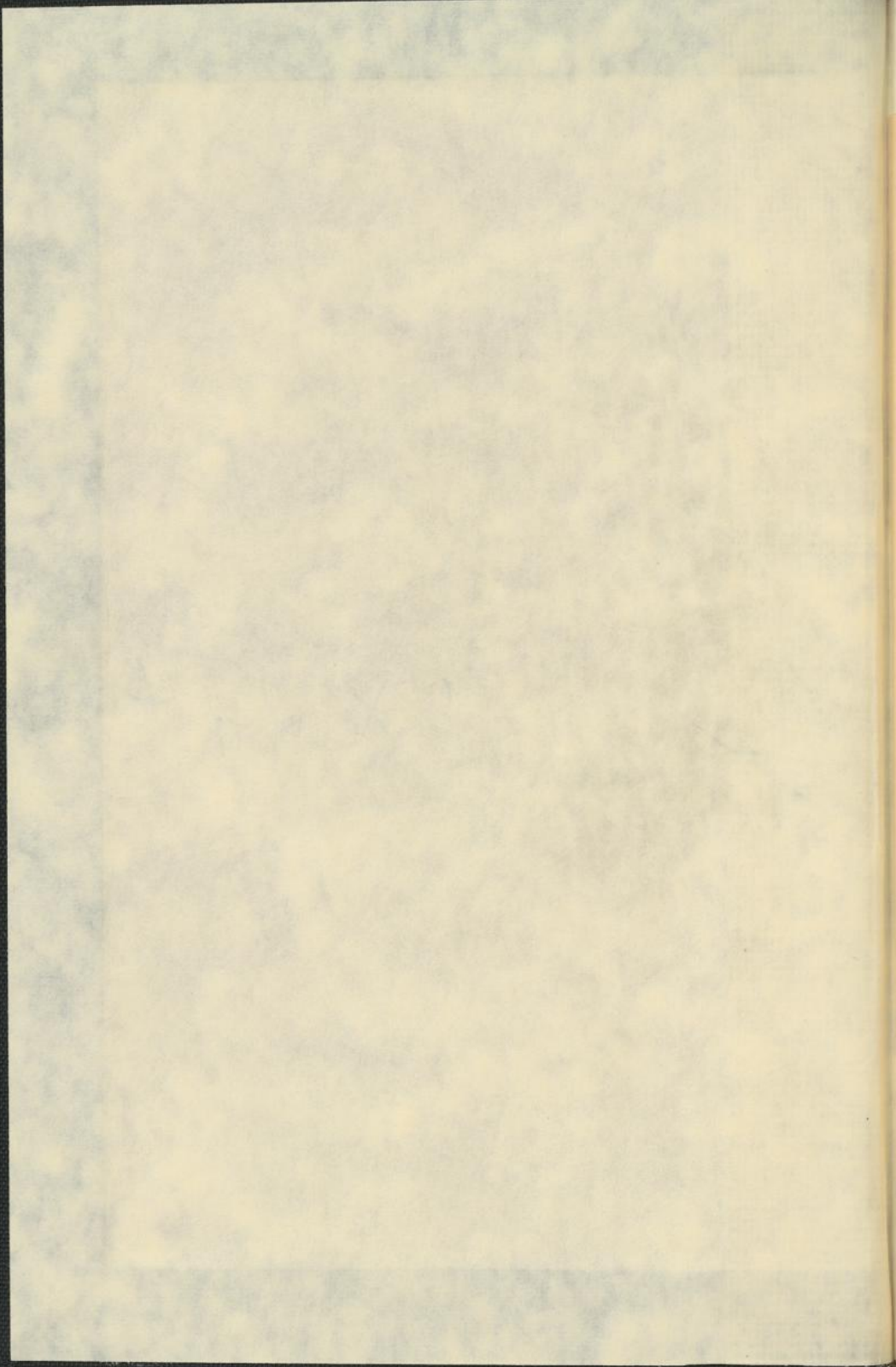
Der Maschinenbau

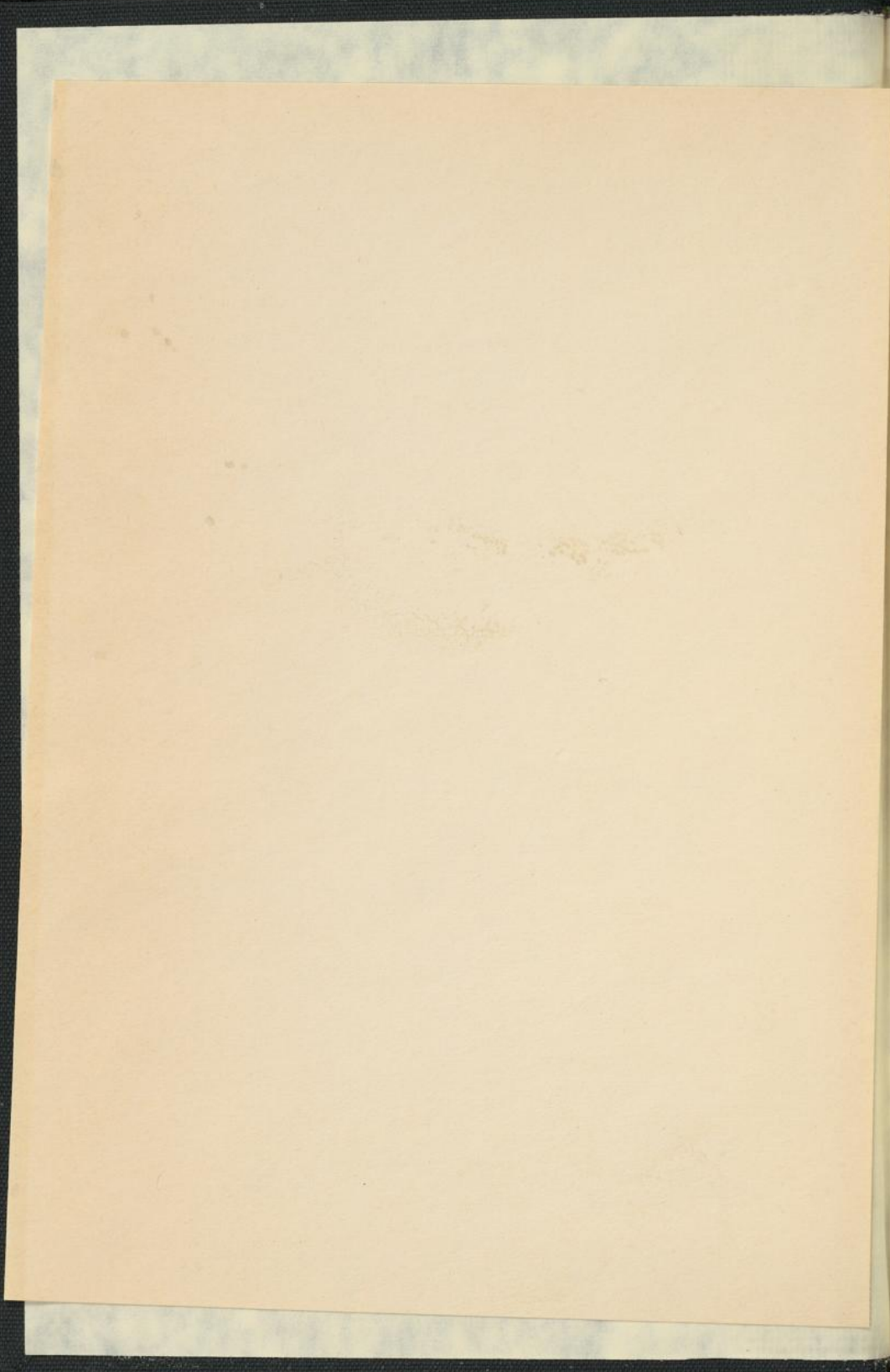
Tafeln zu Bd. 1 - 3

Redtenbacher, Ferdinand

Mannheim, 1862 - 1865

[urn:nbn:de:bsz:31-278587](https://nbn-resolving.org/urn:nbn:de:bsz:31-278587)





Prof. Dr. H. Lorenz
Langfuhr-Danzig.

Redtenbacher, Ferdinand:

Der Maschinenbau.

Tafeln zu Bd 1-3, 1862-1865.



III A 930 -TAF, 1/3

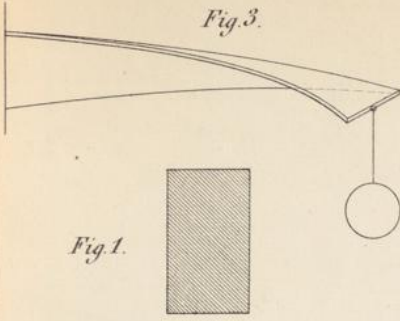


Fig. 1.

Fig. 3.

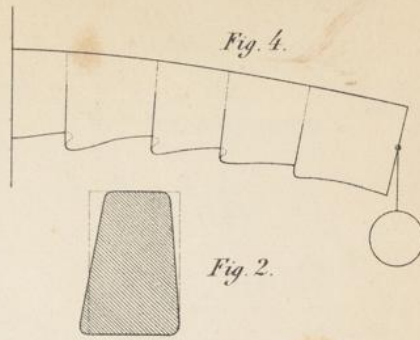


Fig. 2.

Fig. 4.

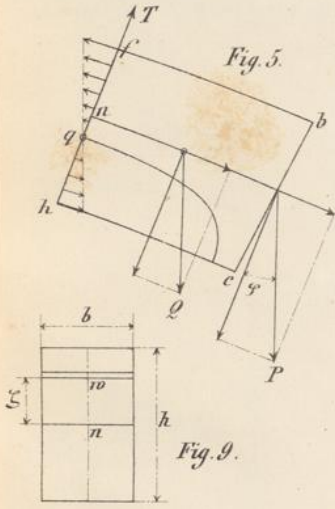


Fig. 5.

Fig. 9.

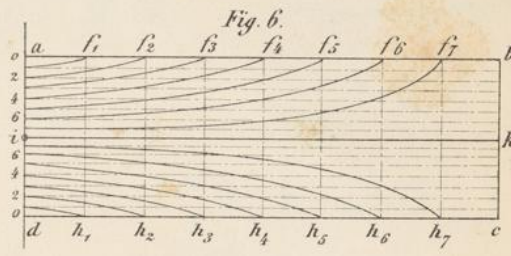


Fig. 6.

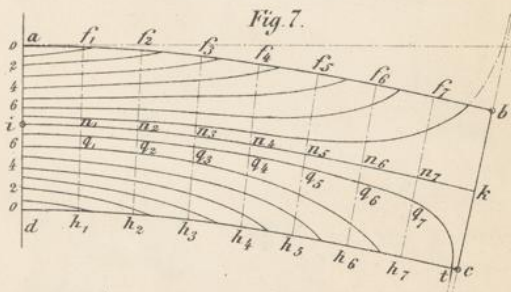


Fig. 7.

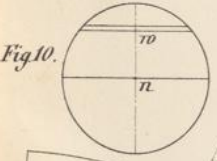


Fig. 10.

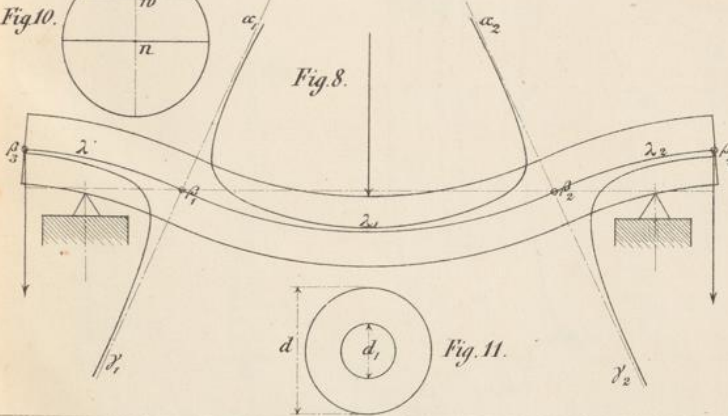


Fig. 8.

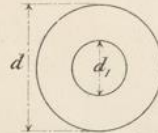


Fig. 11.

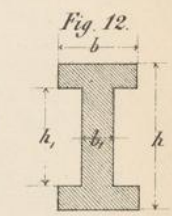


Fig. 12.

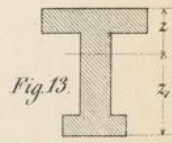
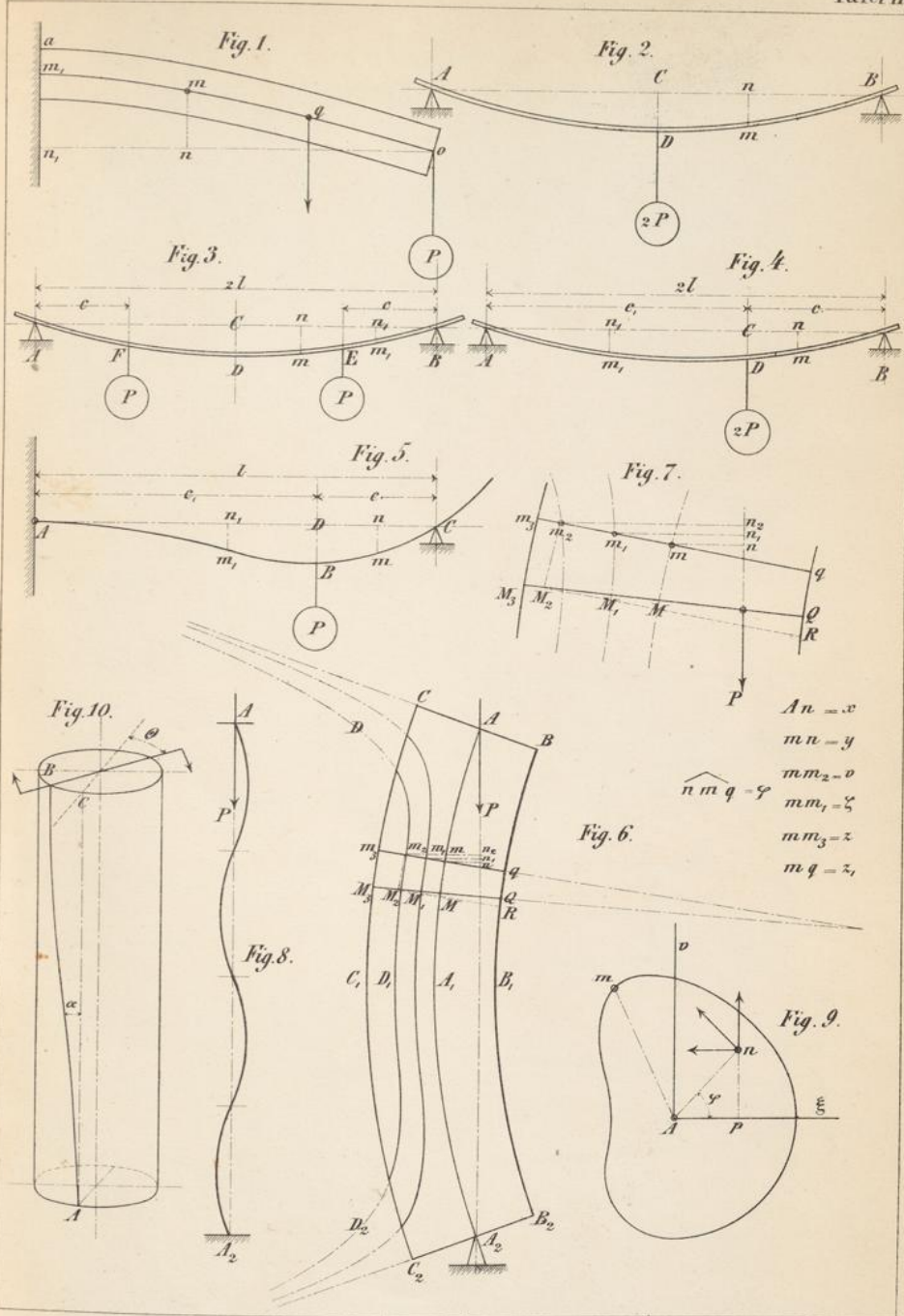


Fig. 13.



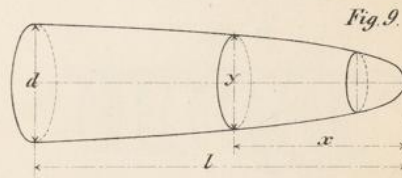
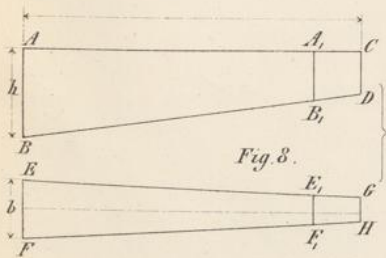
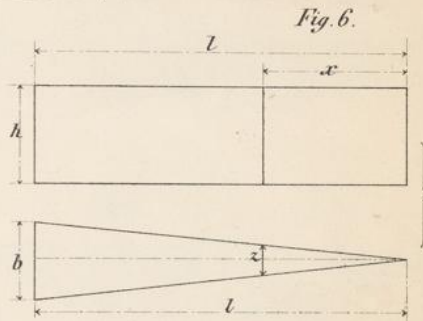
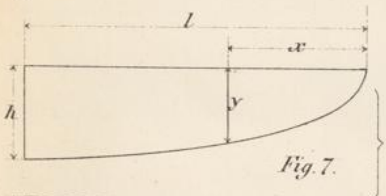
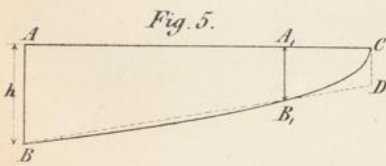
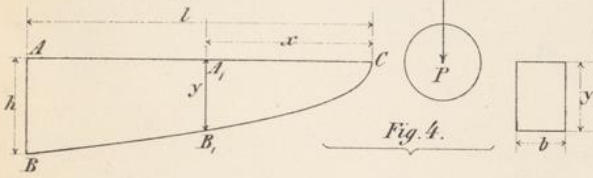
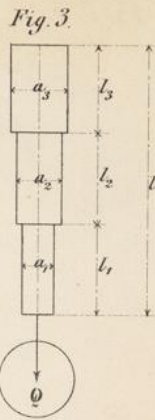
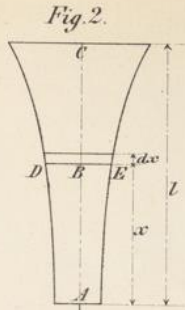
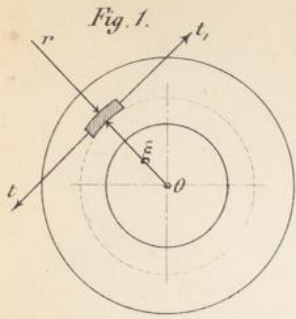


Fig. 1



Fig. 2



Fig. 3

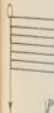
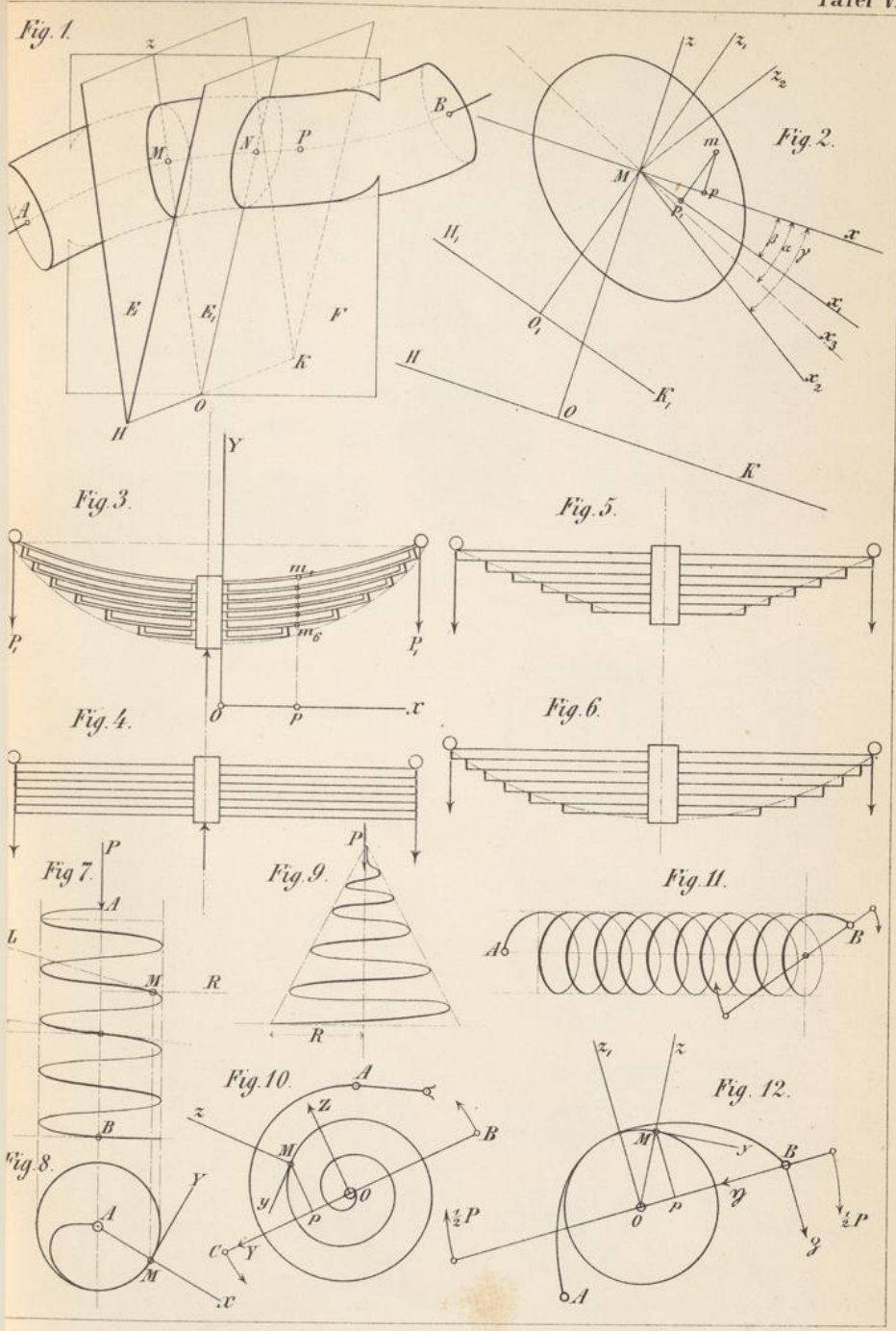


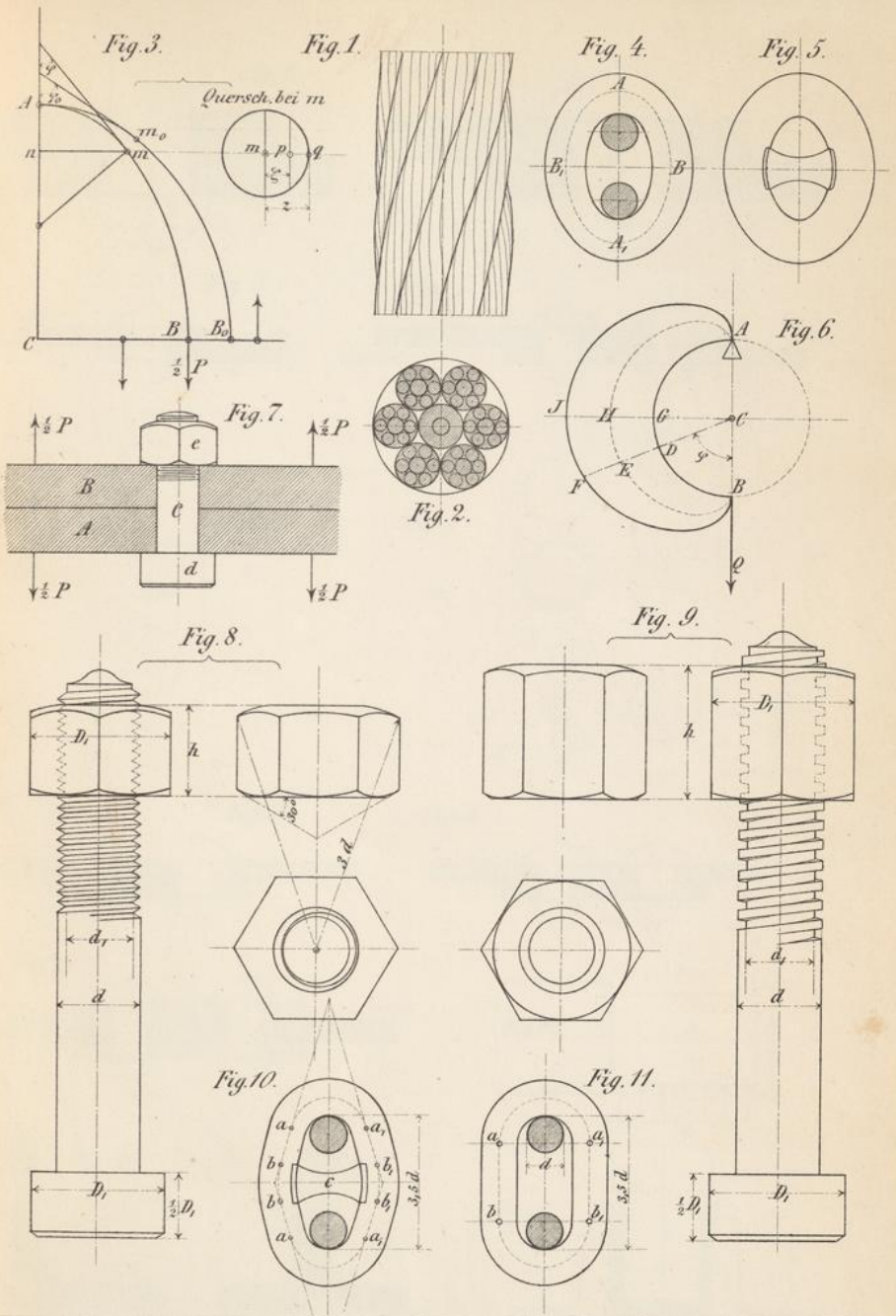
Fig. 4

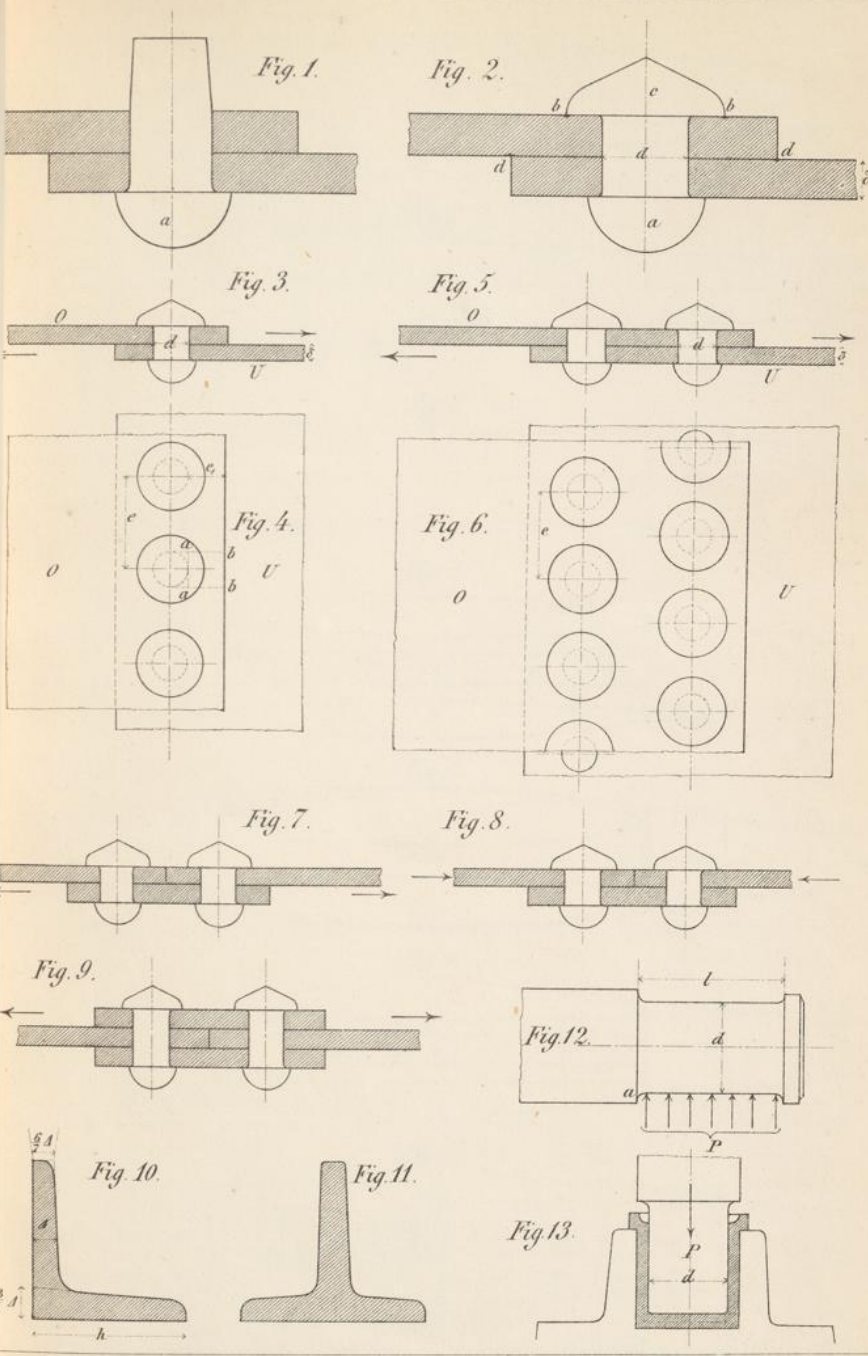


Fig. 5









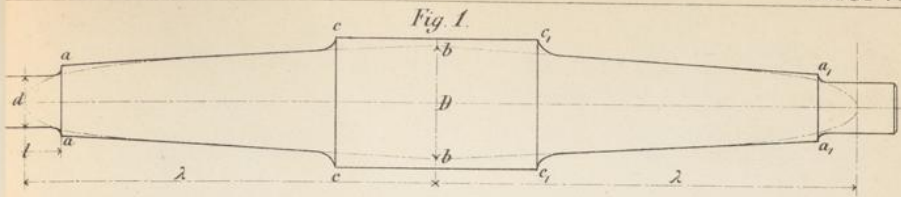


Fig. 1.

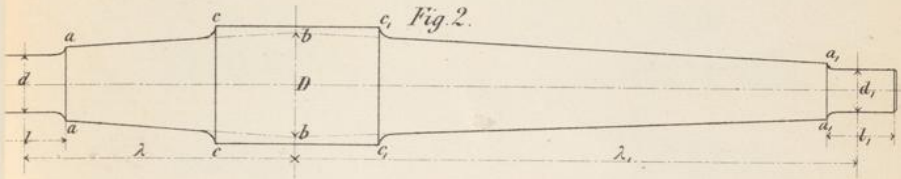


Fig. 2.

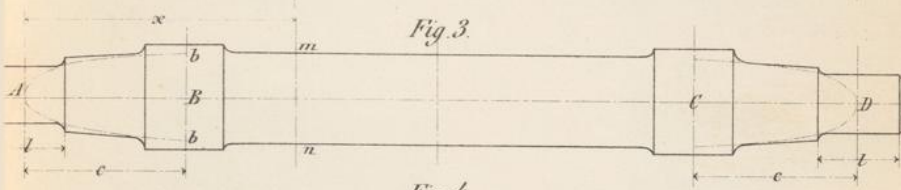


Fig. 3.

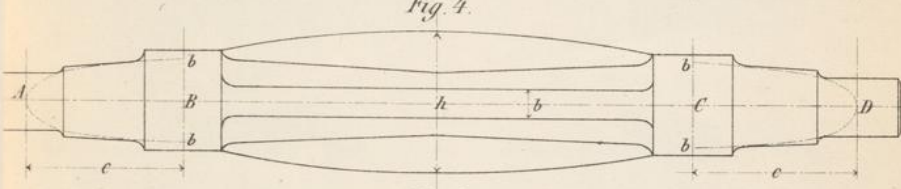


Fig. 4.

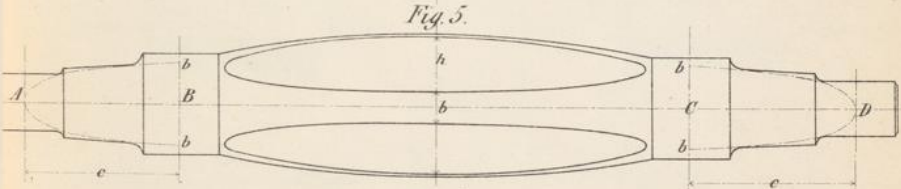


Fig. 5.



Fig. 6.

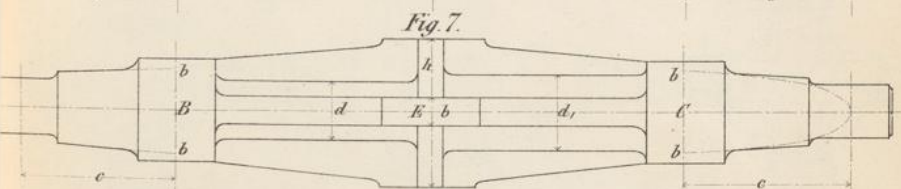
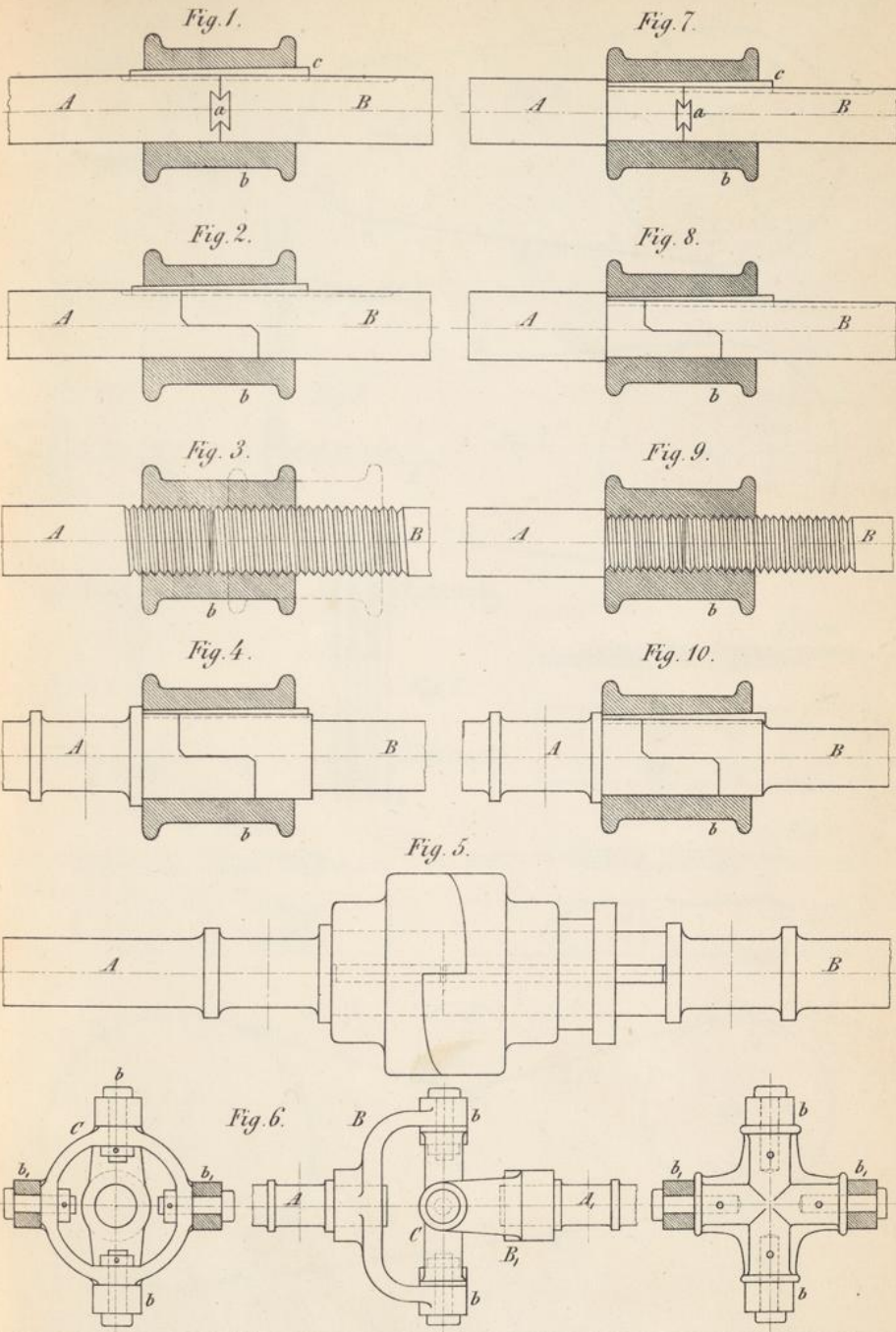


Fig. 7.

Carlsruhe, Lith. Anst. v. L. Geisendorfer



Lith. Anst. v. H. Geisendörfer, Carlsruhe

Fig. 1.

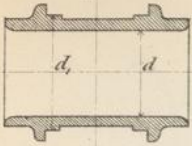


Fig. 2.

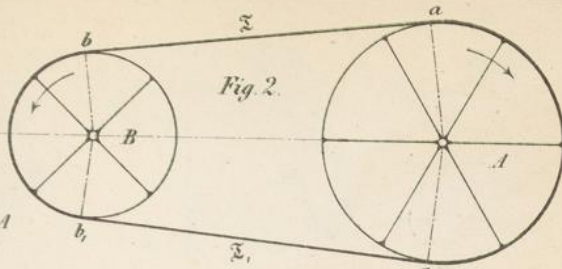


Fig. 4.

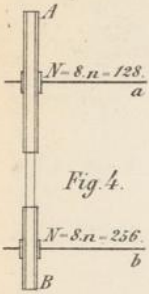


Fig. 5.

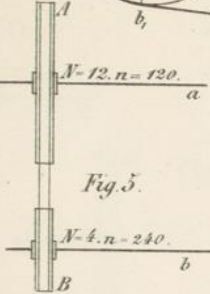


Fig. 3.

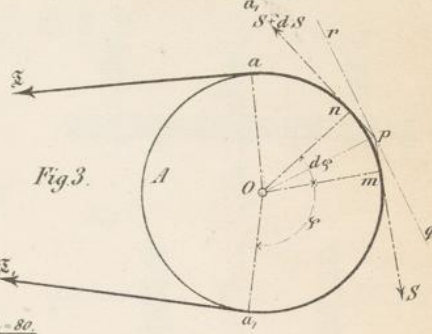


Fig. 6.

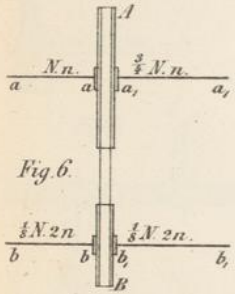


Fig. 7.

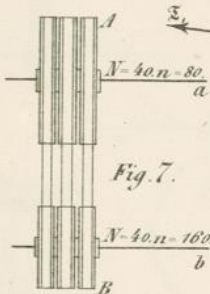


Fig. 10.

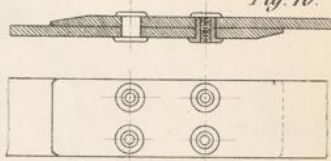


Fig. 8.

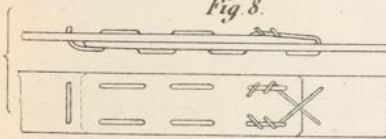


Fig. 9.

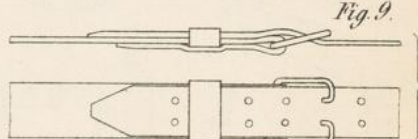
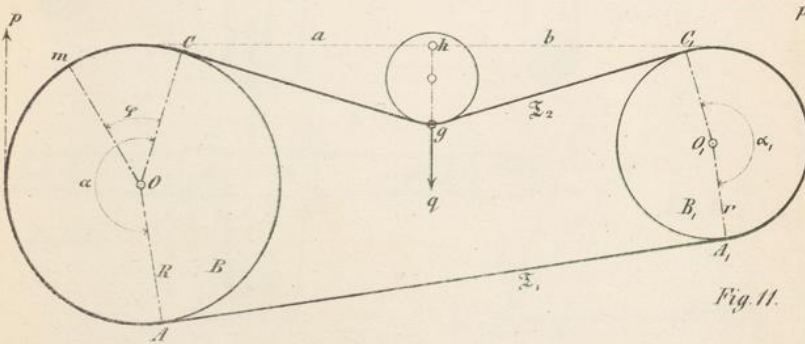
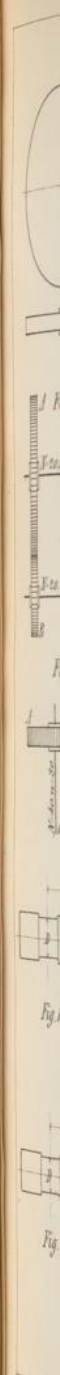
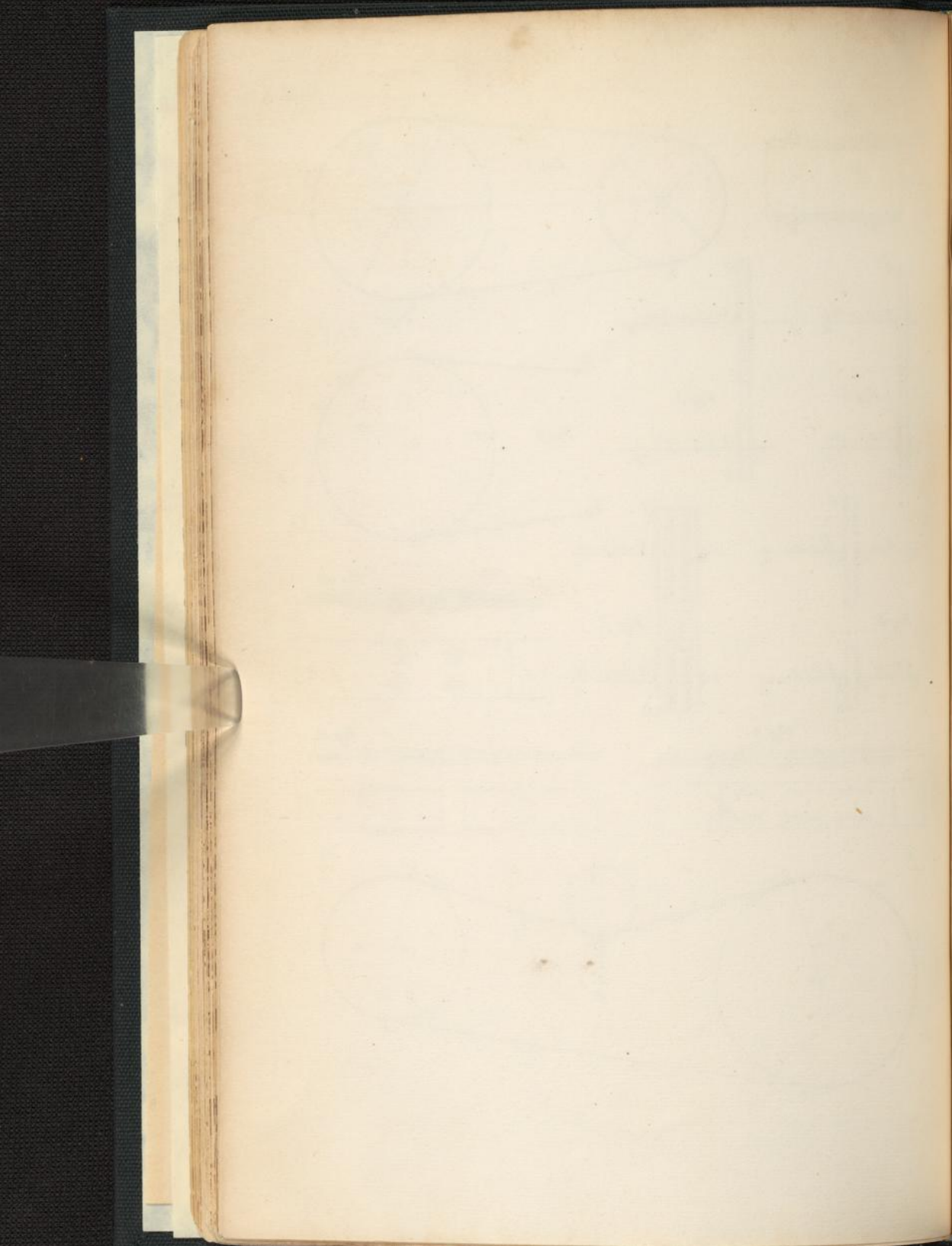
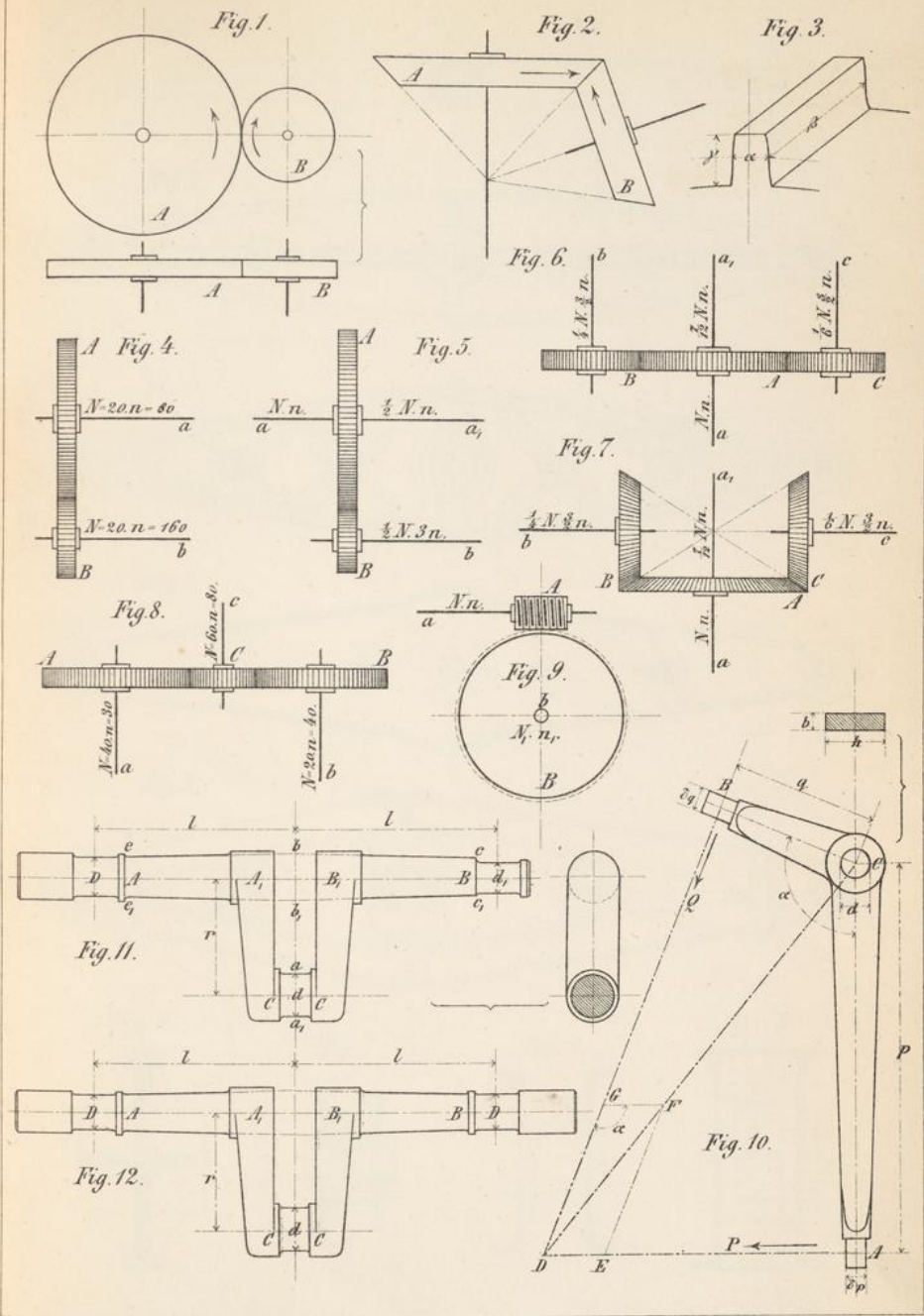


Fig. 11.







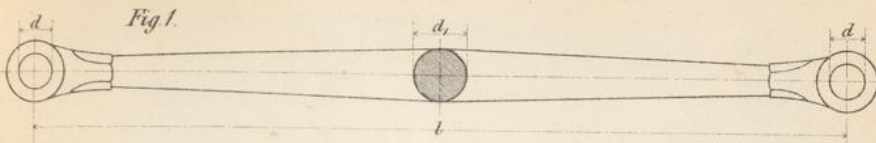


Fig. 1.

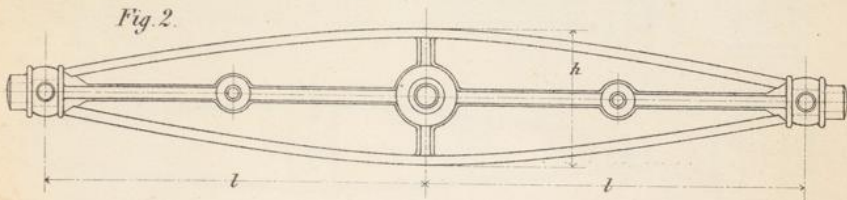


Fig. 2.

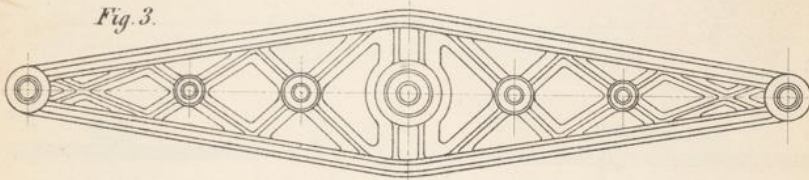


Fig. 3.

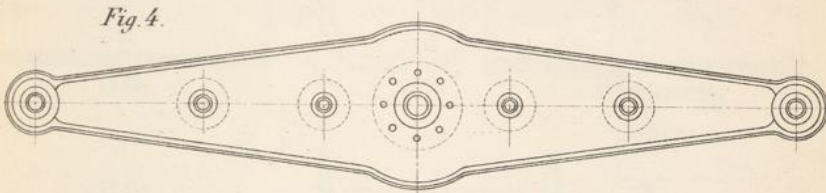


Fig. 4.

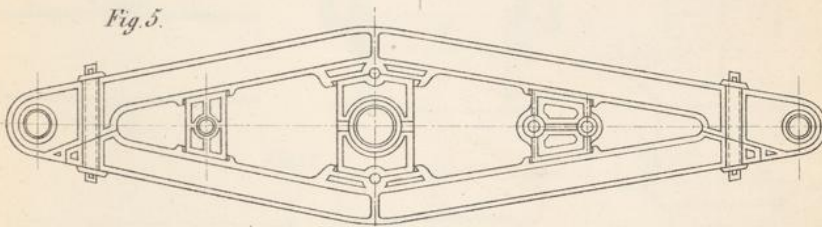


Fig. 5.

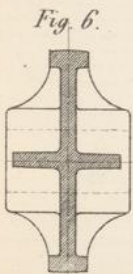


Fig. 6.

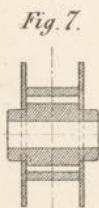


Fig. 7.

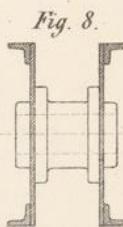


Fig. 8.

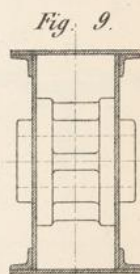
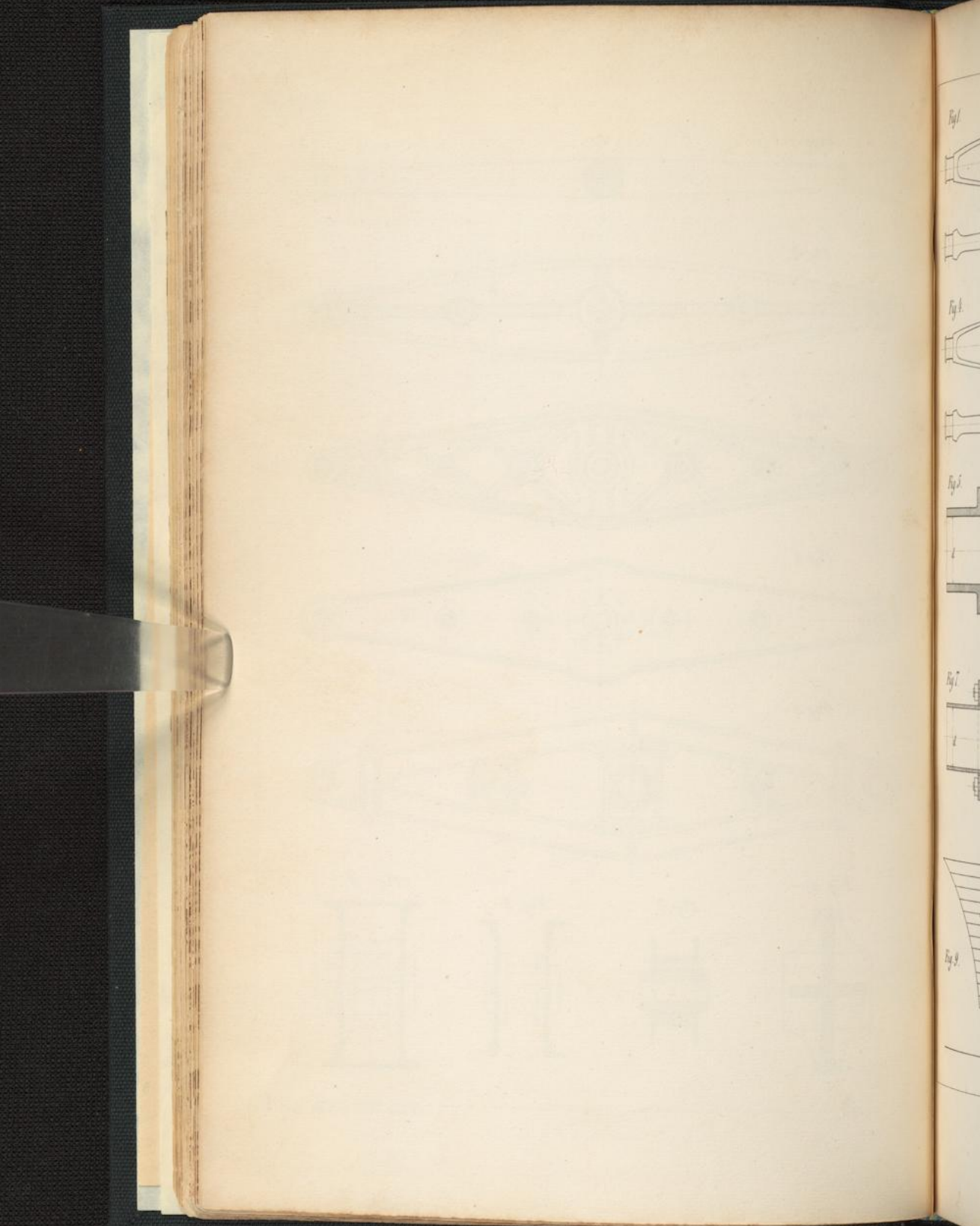
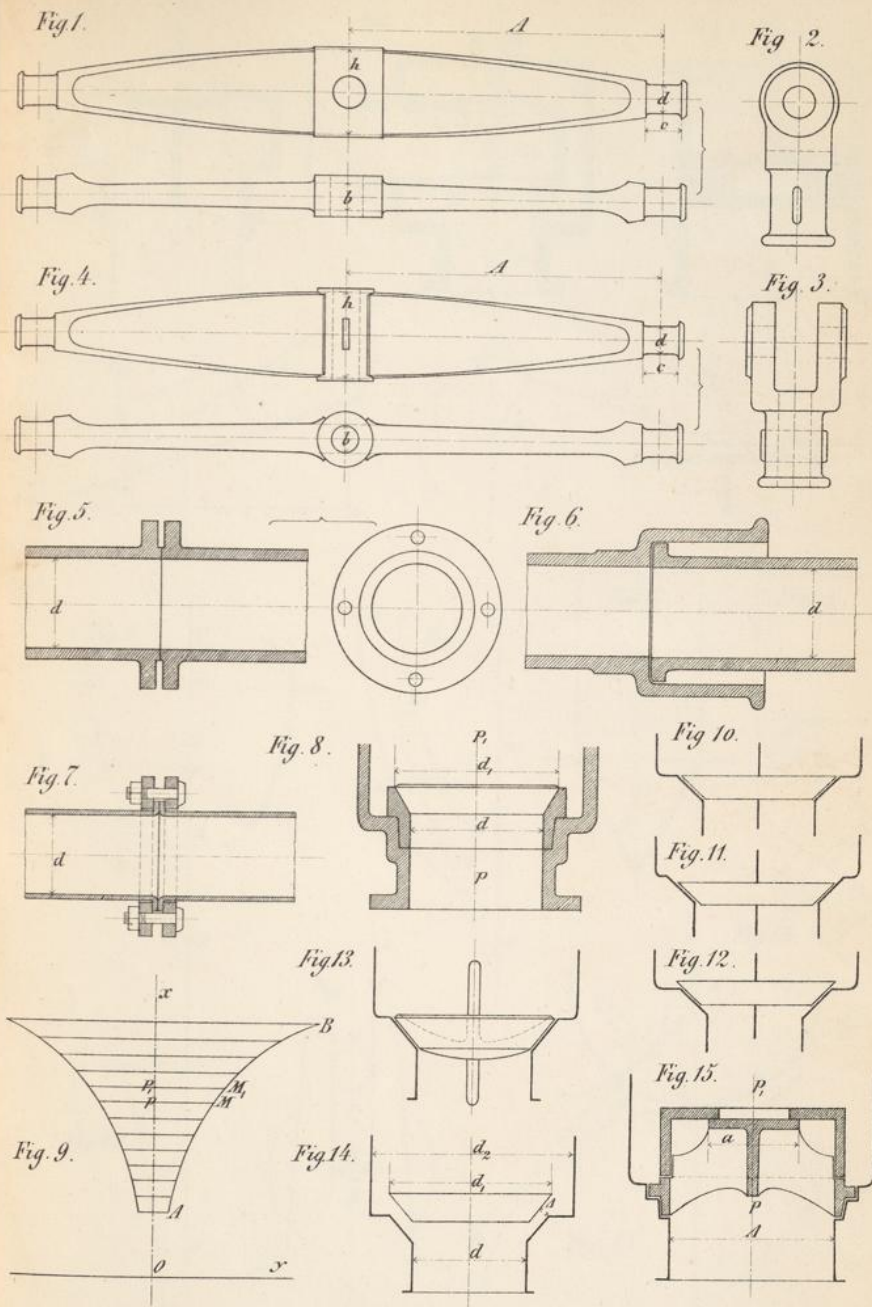
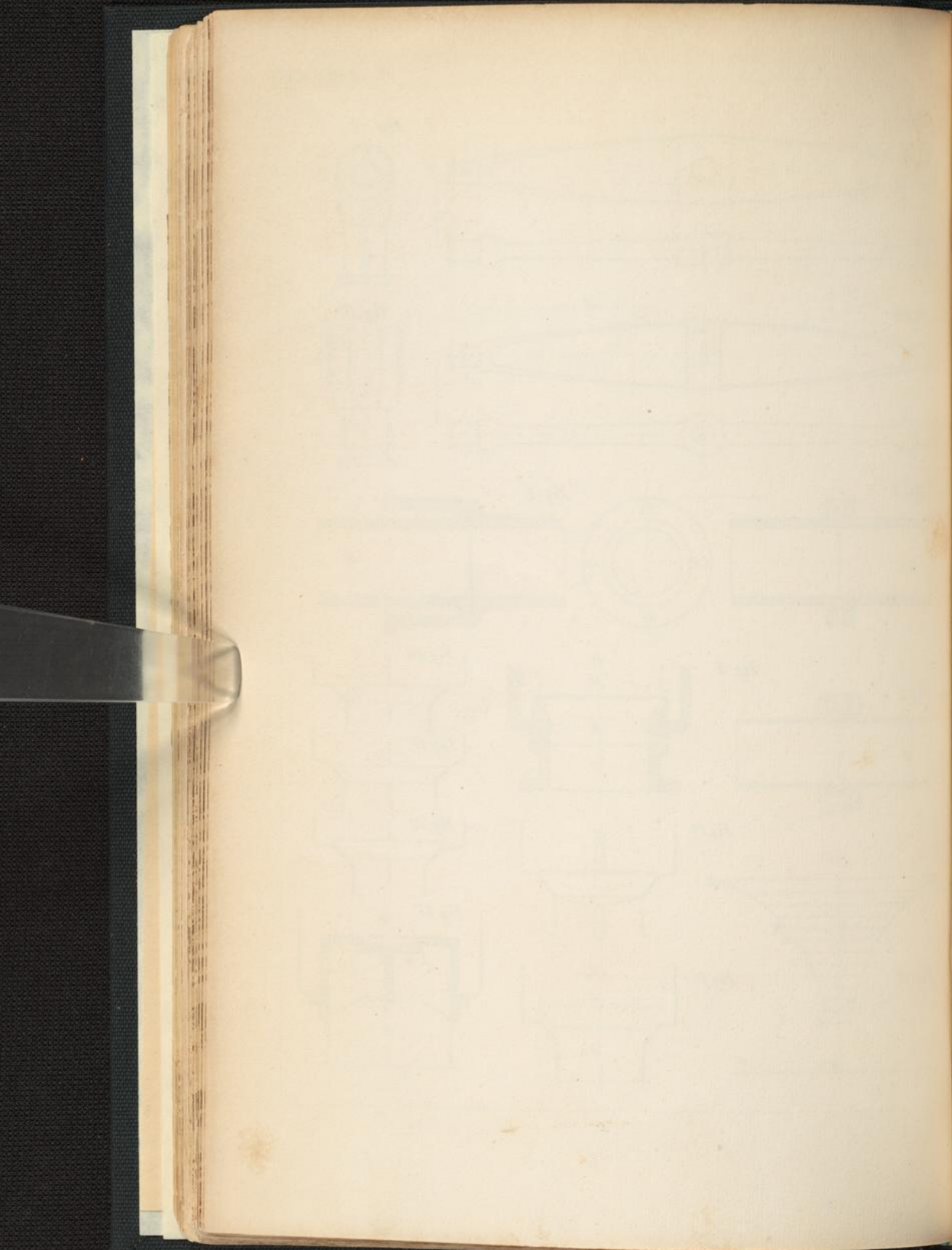


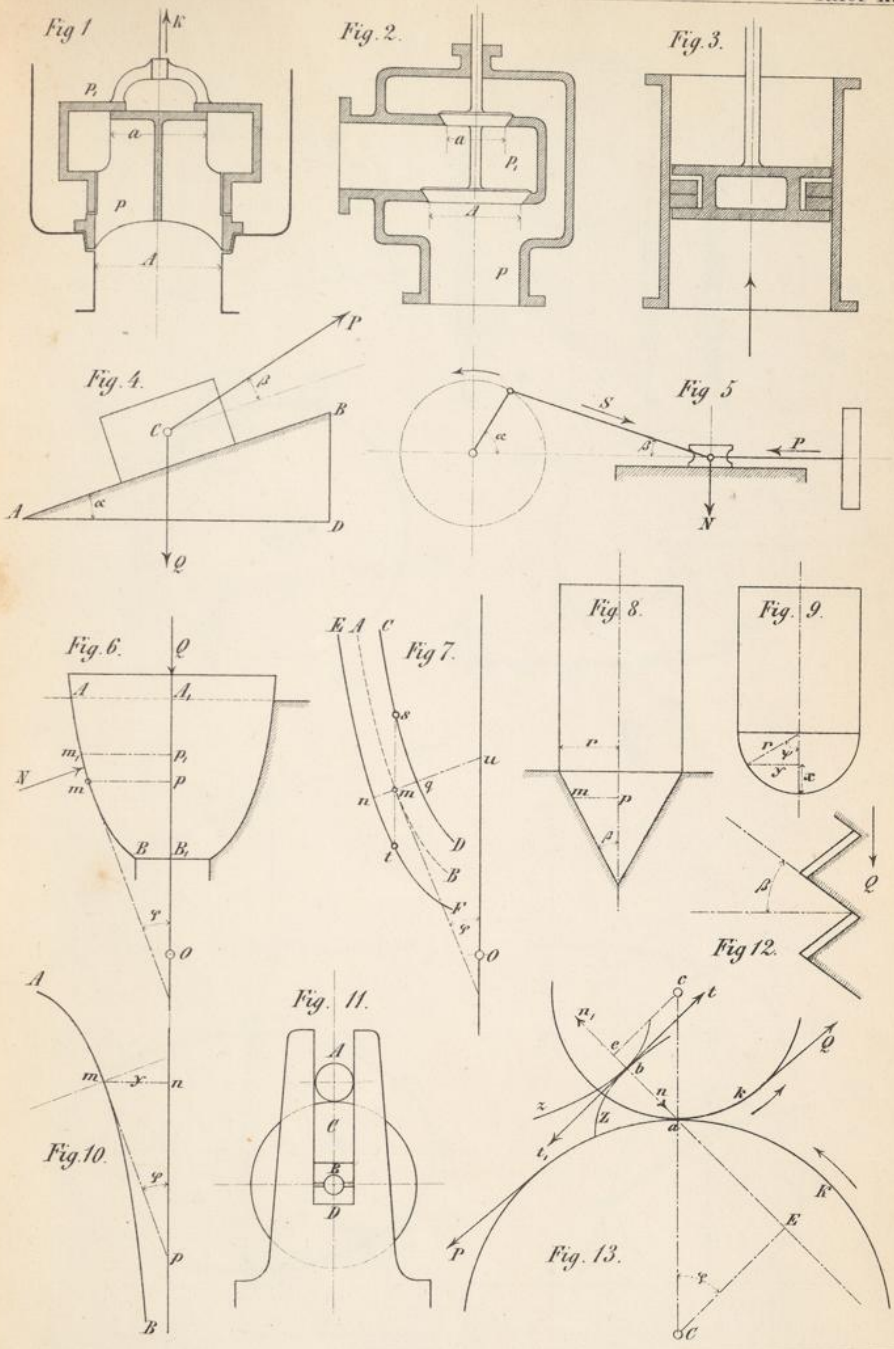
Fig. 9.

Lith. Anst. v. L. Geisendorfer, Carlsruhe.









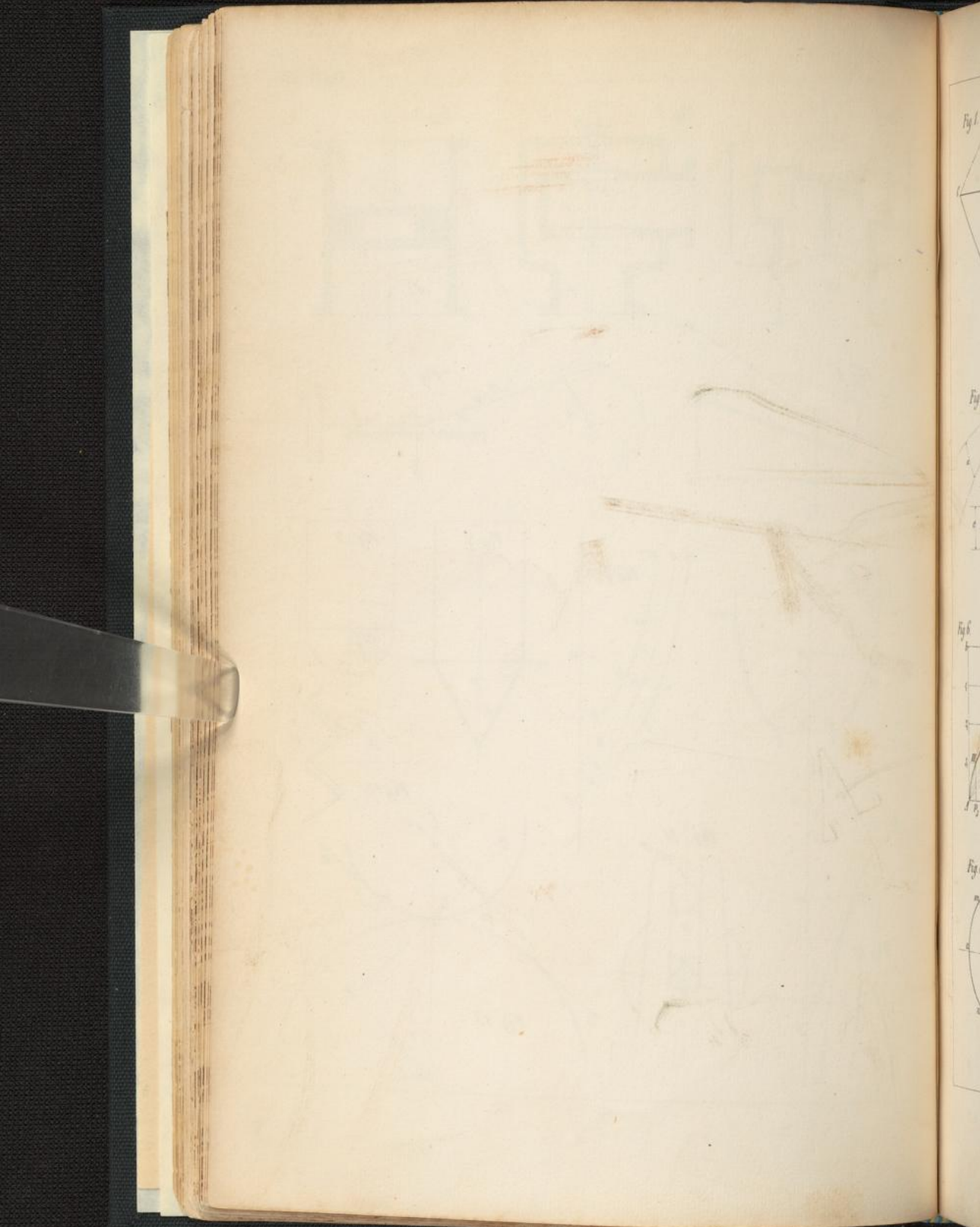


Fig. 1

Fig. 2

Fig. 3

Fig. 4

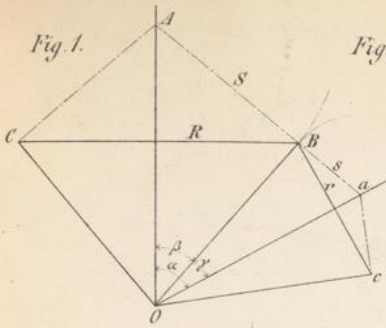


Fig. 2.

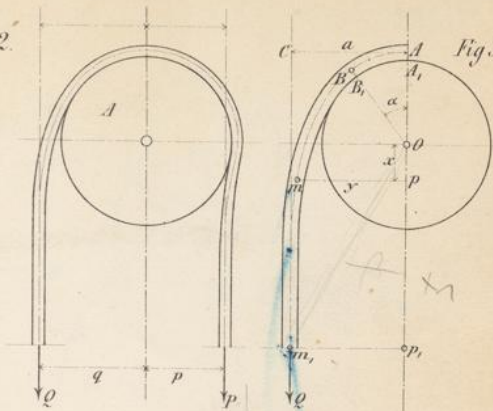


Fig. 3

Fig. 4.

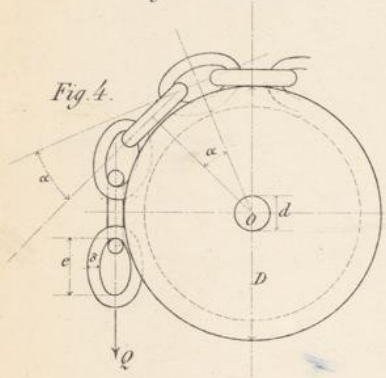


Fig. 5

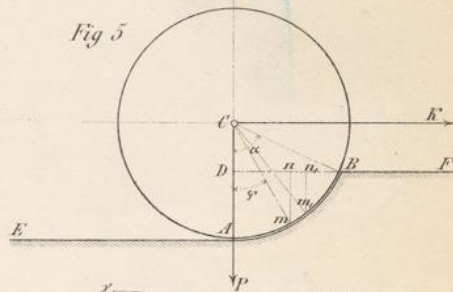


Fig. 6.

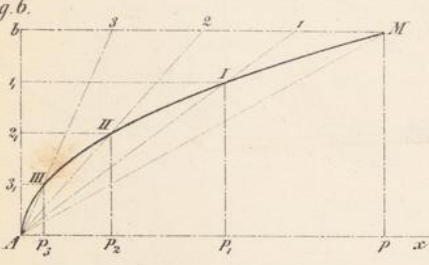


Fig. 7.

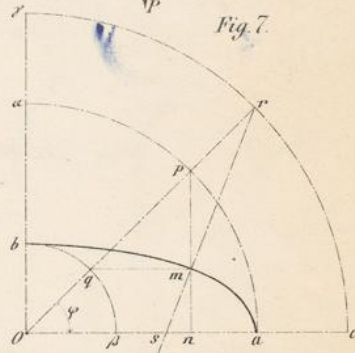


Fig. 8.

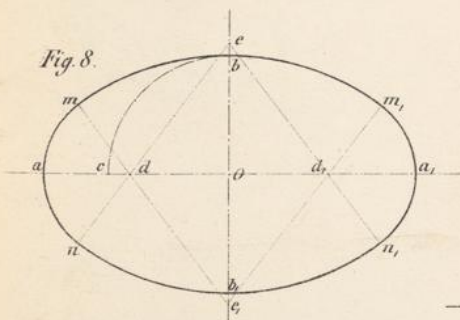
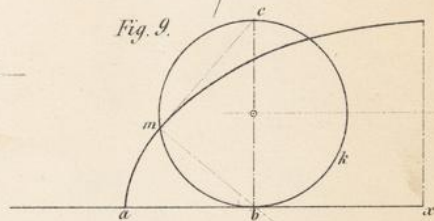
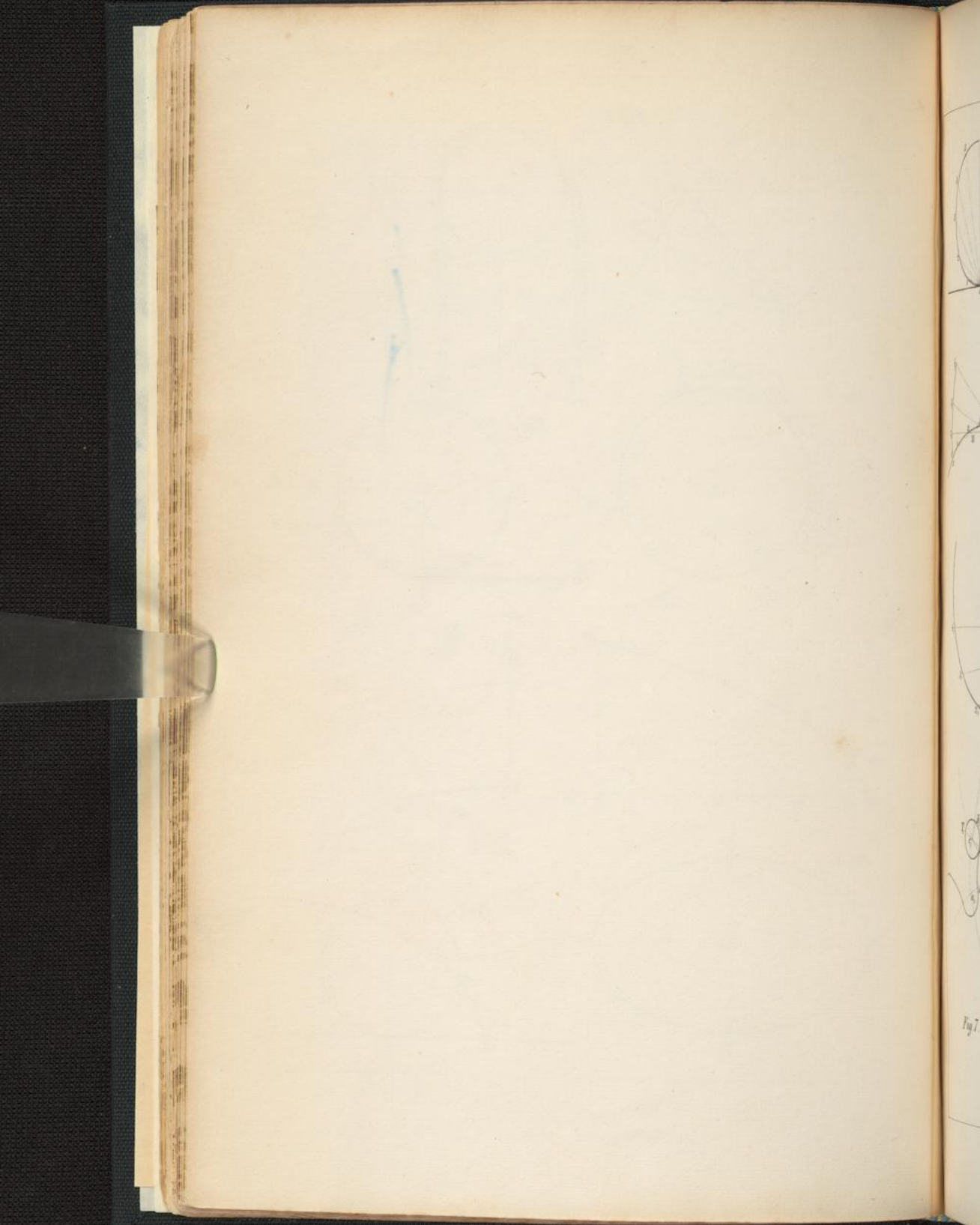
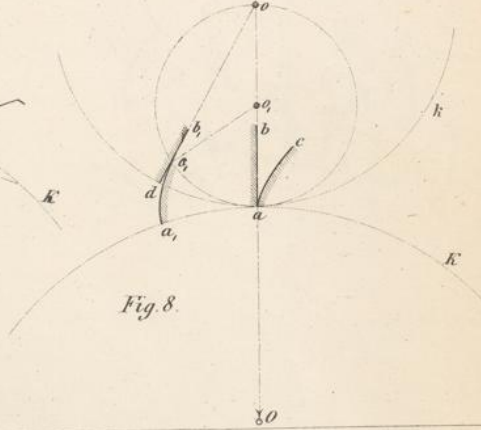
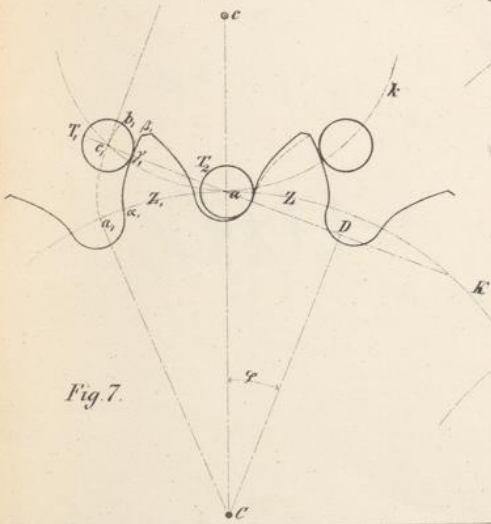
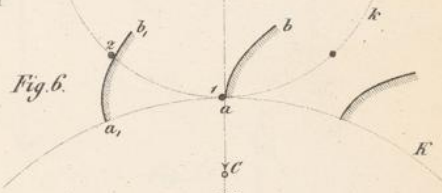
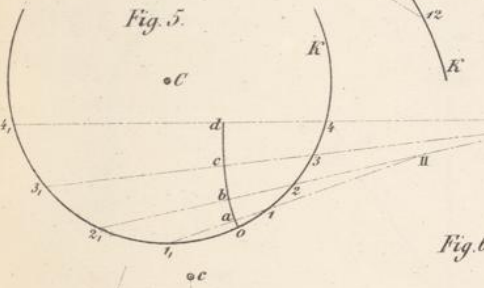
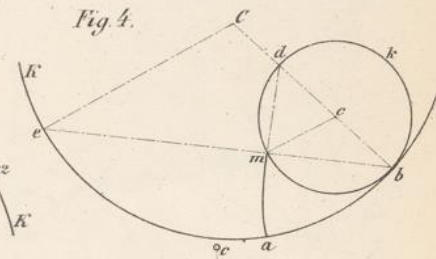
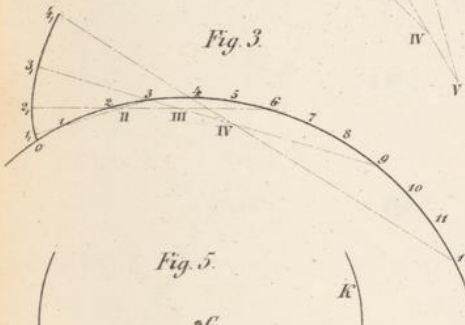
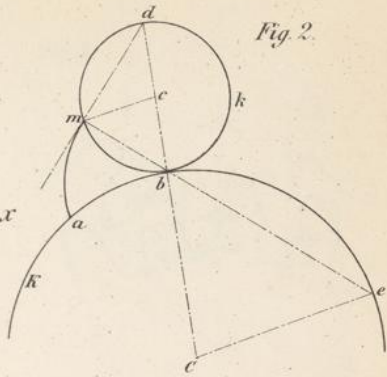
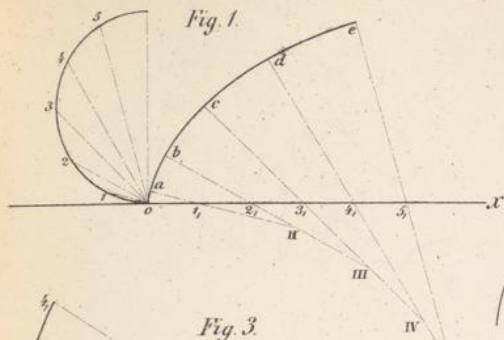
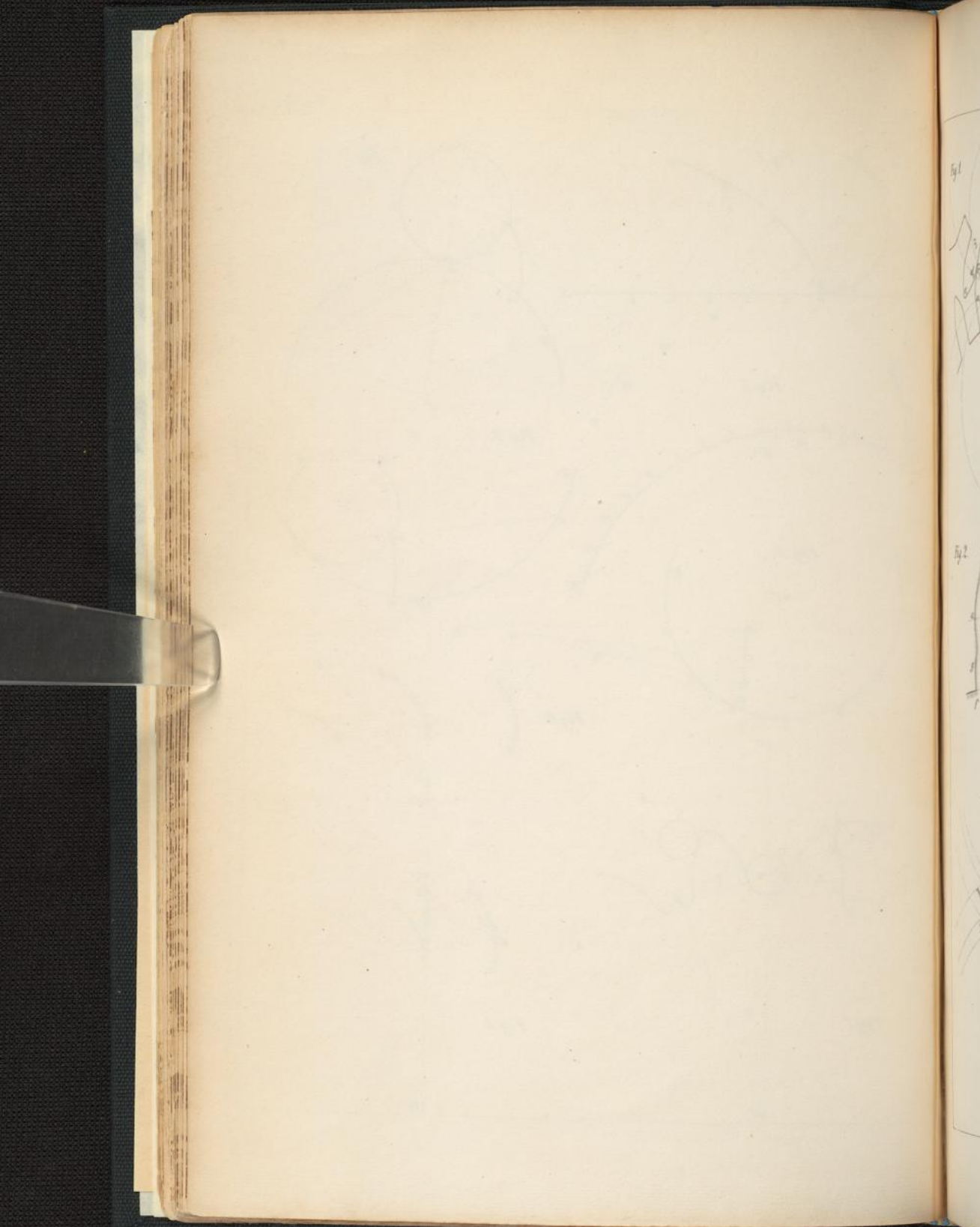


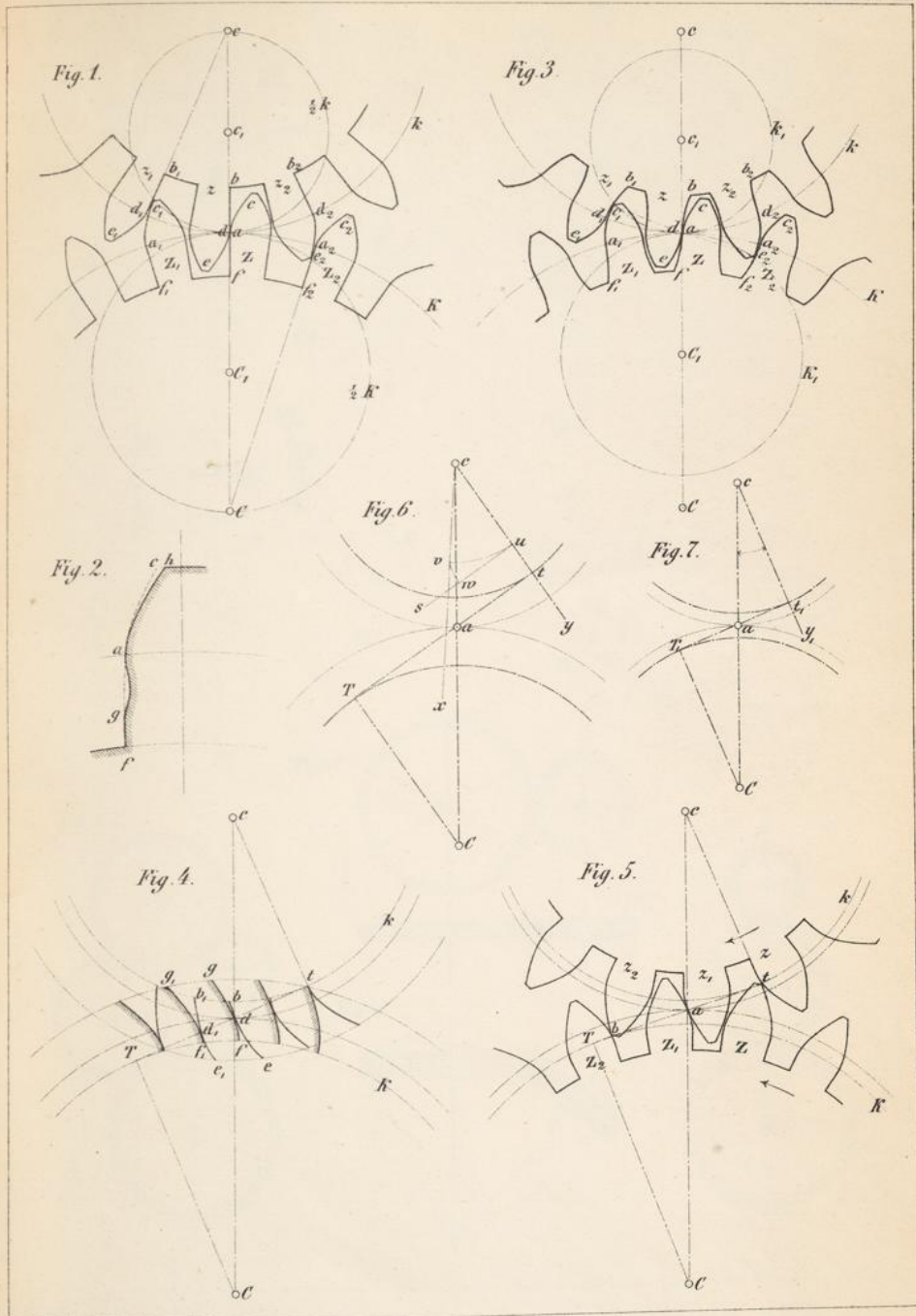
Fig. 9.











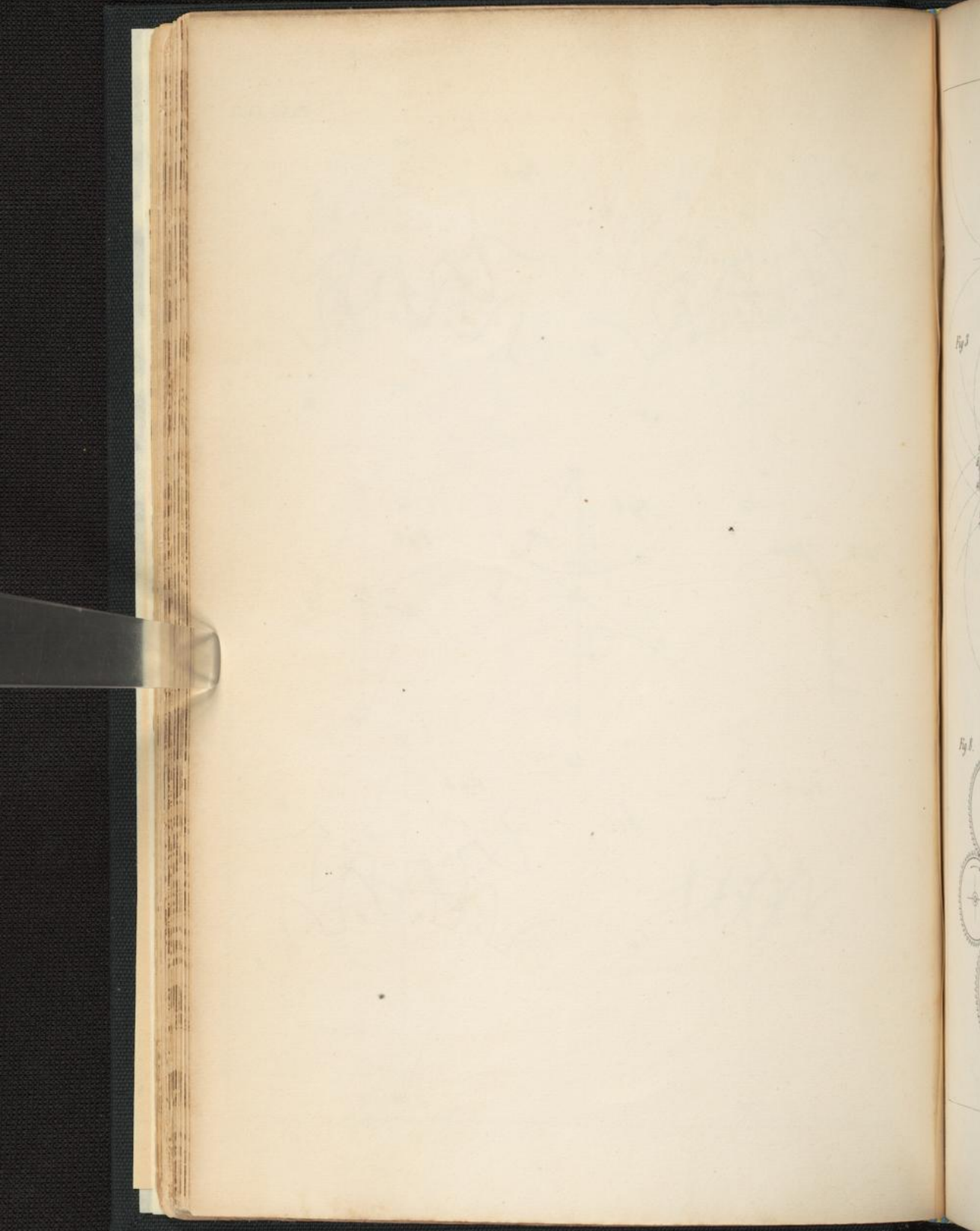


Fig. 1.

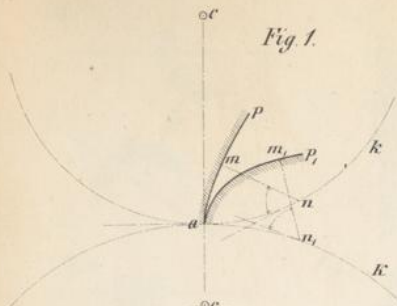


Fig. 2.

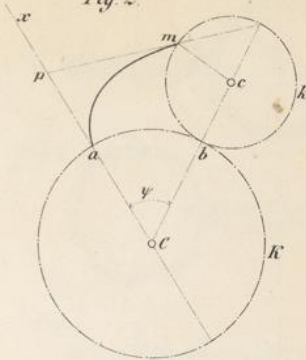


Fig. 3.

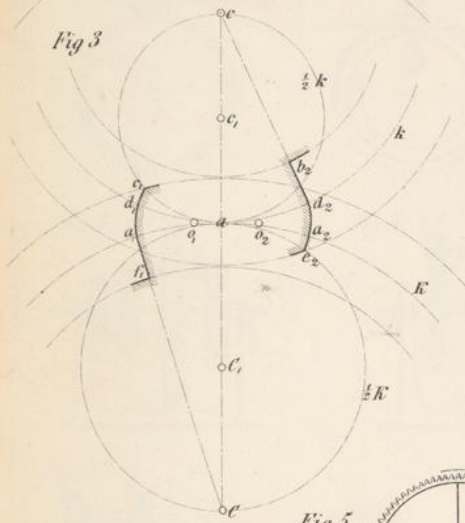


Fig. 4.

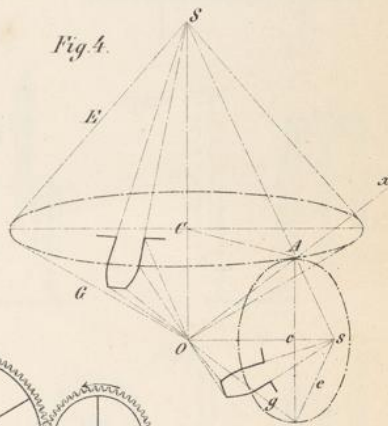


Fig. 5.

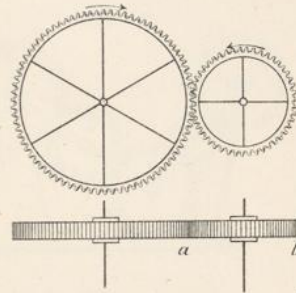


Fig. 8.

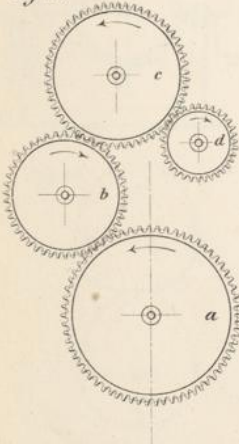


Fig. 6.

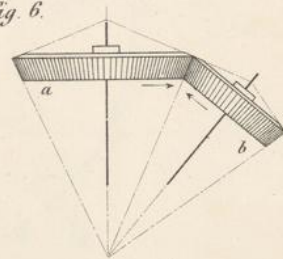
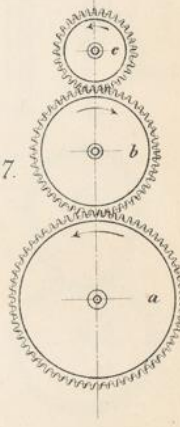
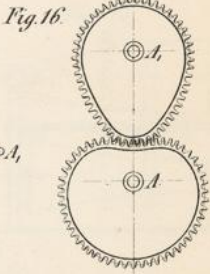
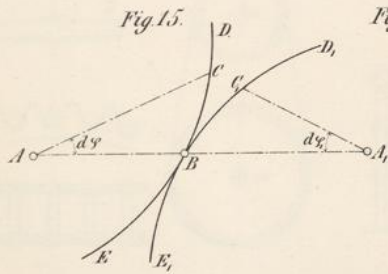
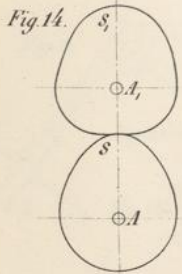
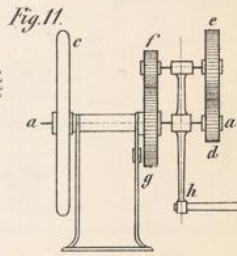
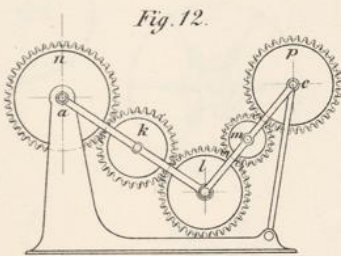
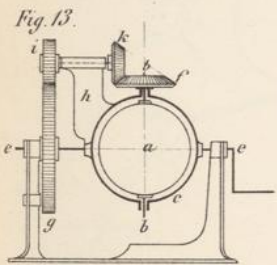
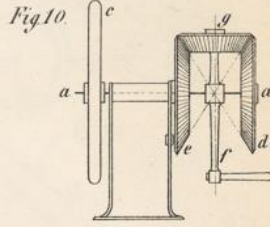
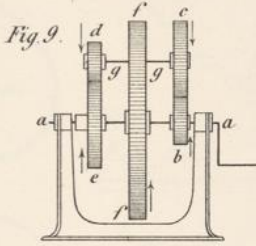
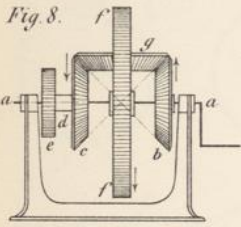
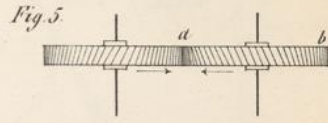
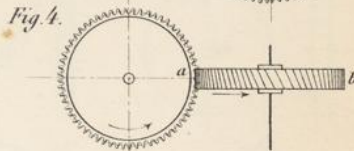
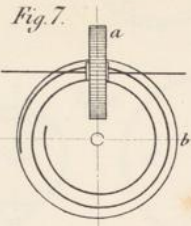
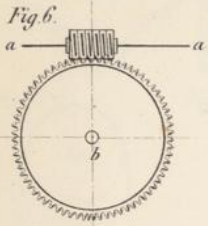
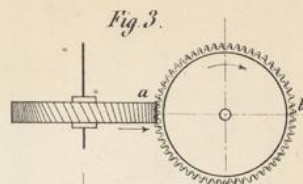
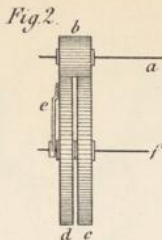
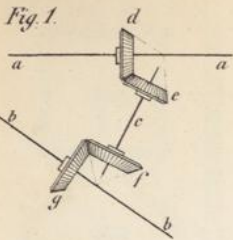


Fig. 7.





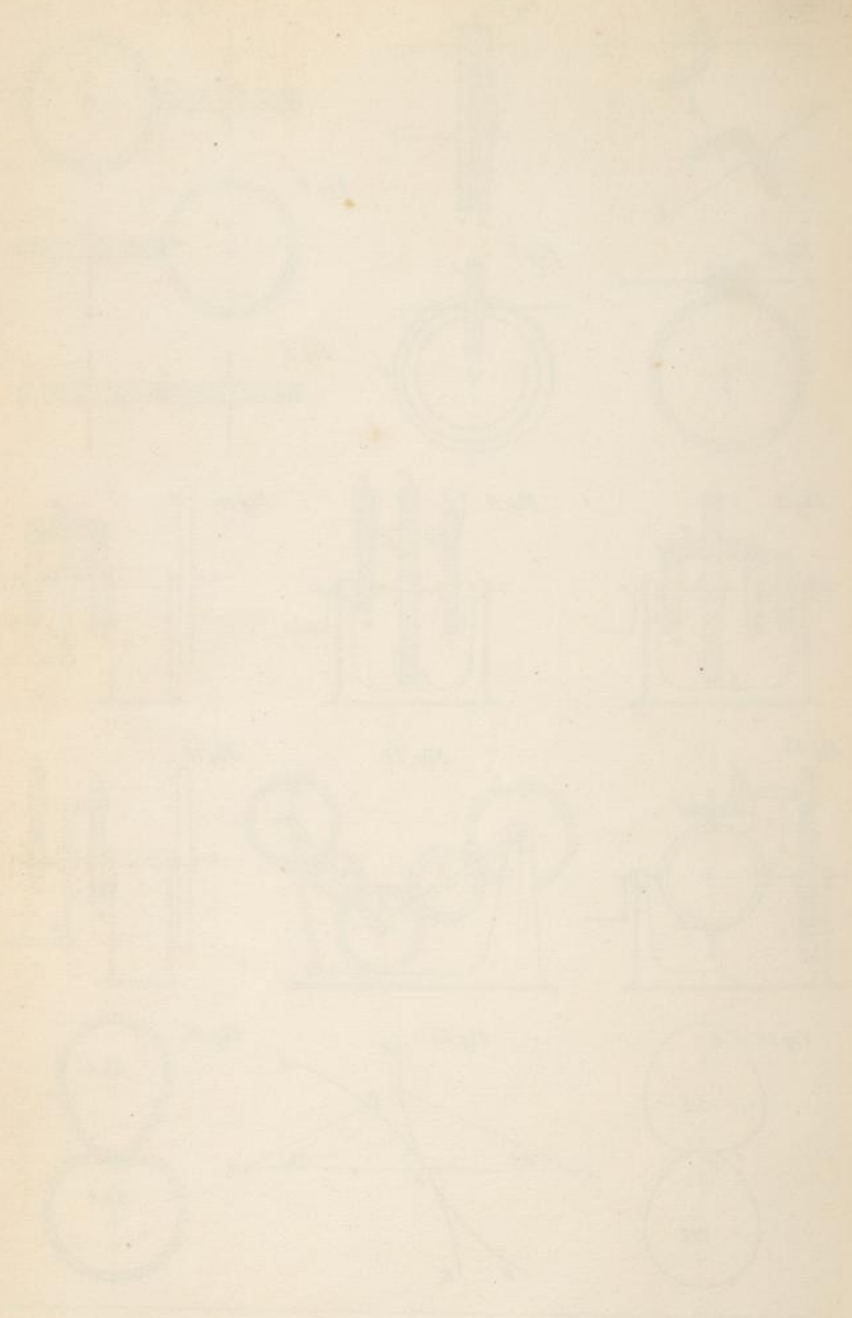


Fig. 1.

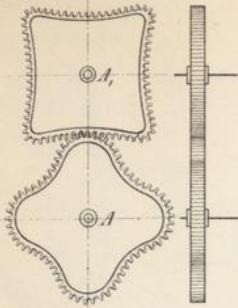


Fig. 2.

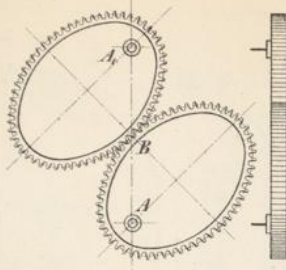


Fig. 3.

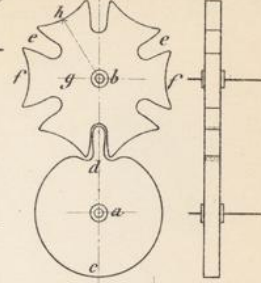


Fig. 4.

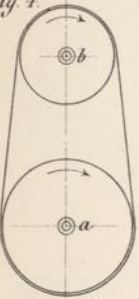


Fig. 5.

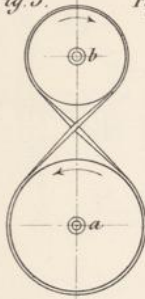


Fig. 6.

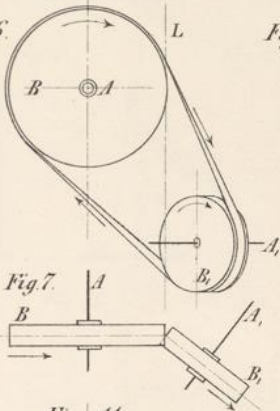


Fig. 10.

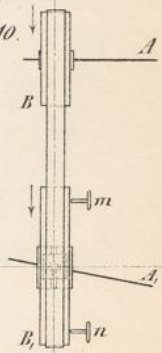


Fig. 7.

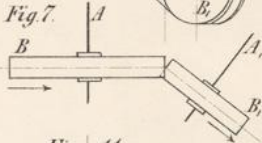


Fig. 8.

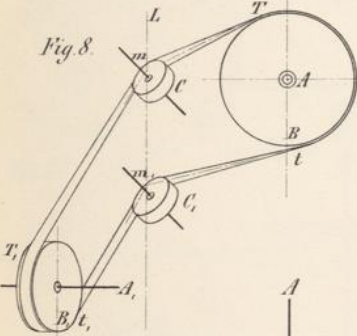


Fig. 11.

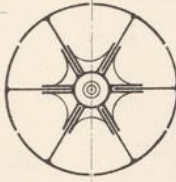


Fig. 12.

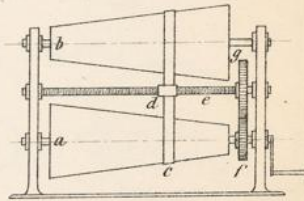


Fig. 9.

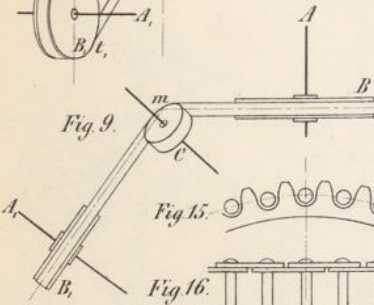


Fig. 14.

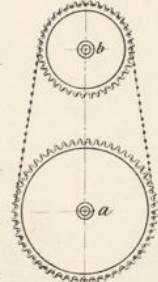


Fig. 13.

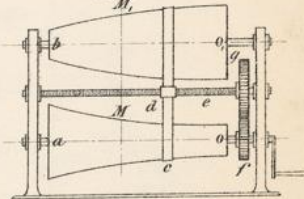
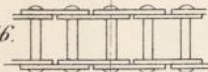


Fig. 15.



Fig. 16.



Lith. v. L. Geisenhöfer, Karlsruhe.

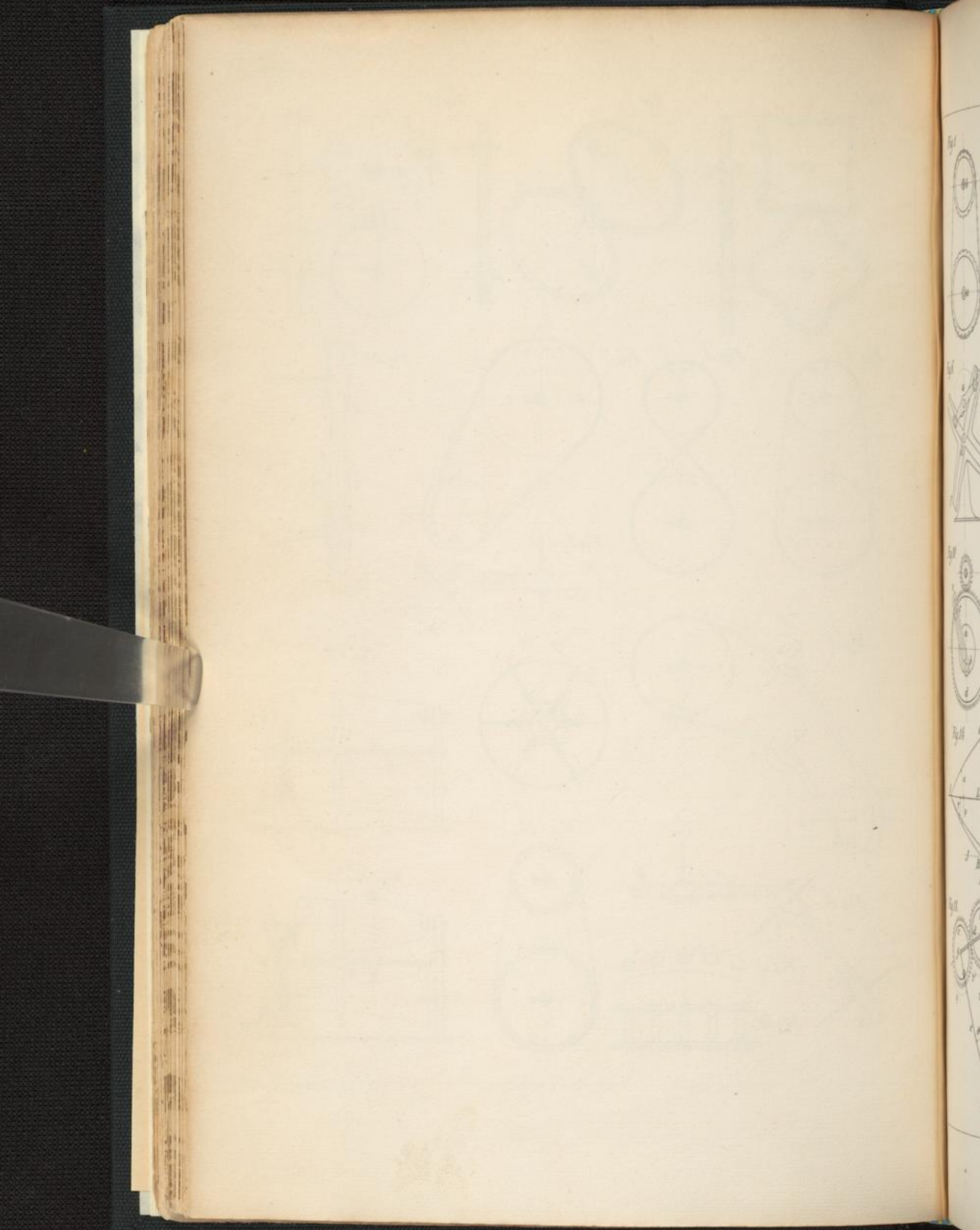


Fig. 1.

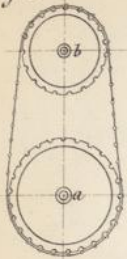


Fig. 2.



Fig. 3.

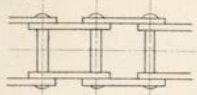


Fig. 4.

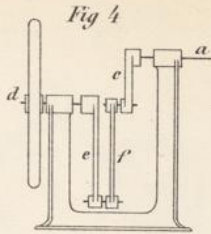


Fig. 5.

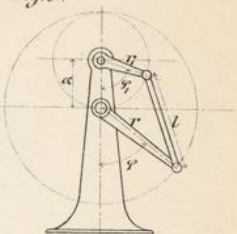


Fig. 6.

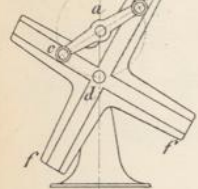


Fig. 7.

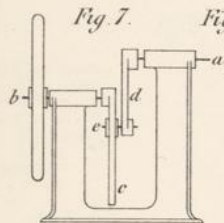


Fig. 8.

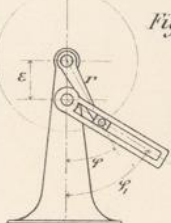


Fig. 9.

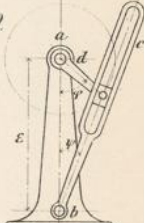


Fig. 10.

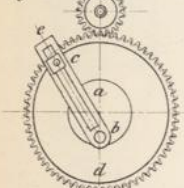


Fig. 11.

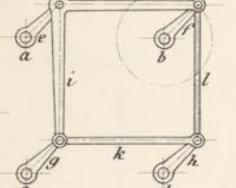


Fig. 12.

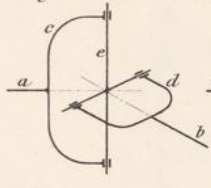


Fig. 13.

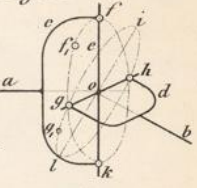


Fig. 14.

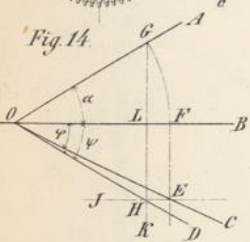


Fig. 15.

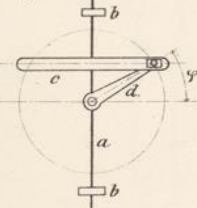


Fig. 16.

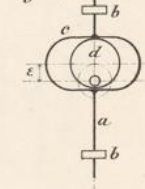


Fig. 17.

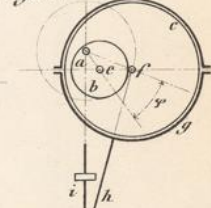


Fig. 18.

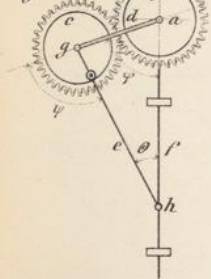


Fig. 19.

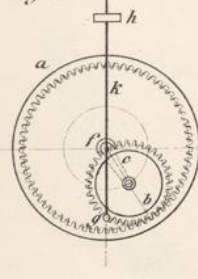
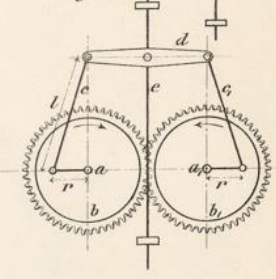
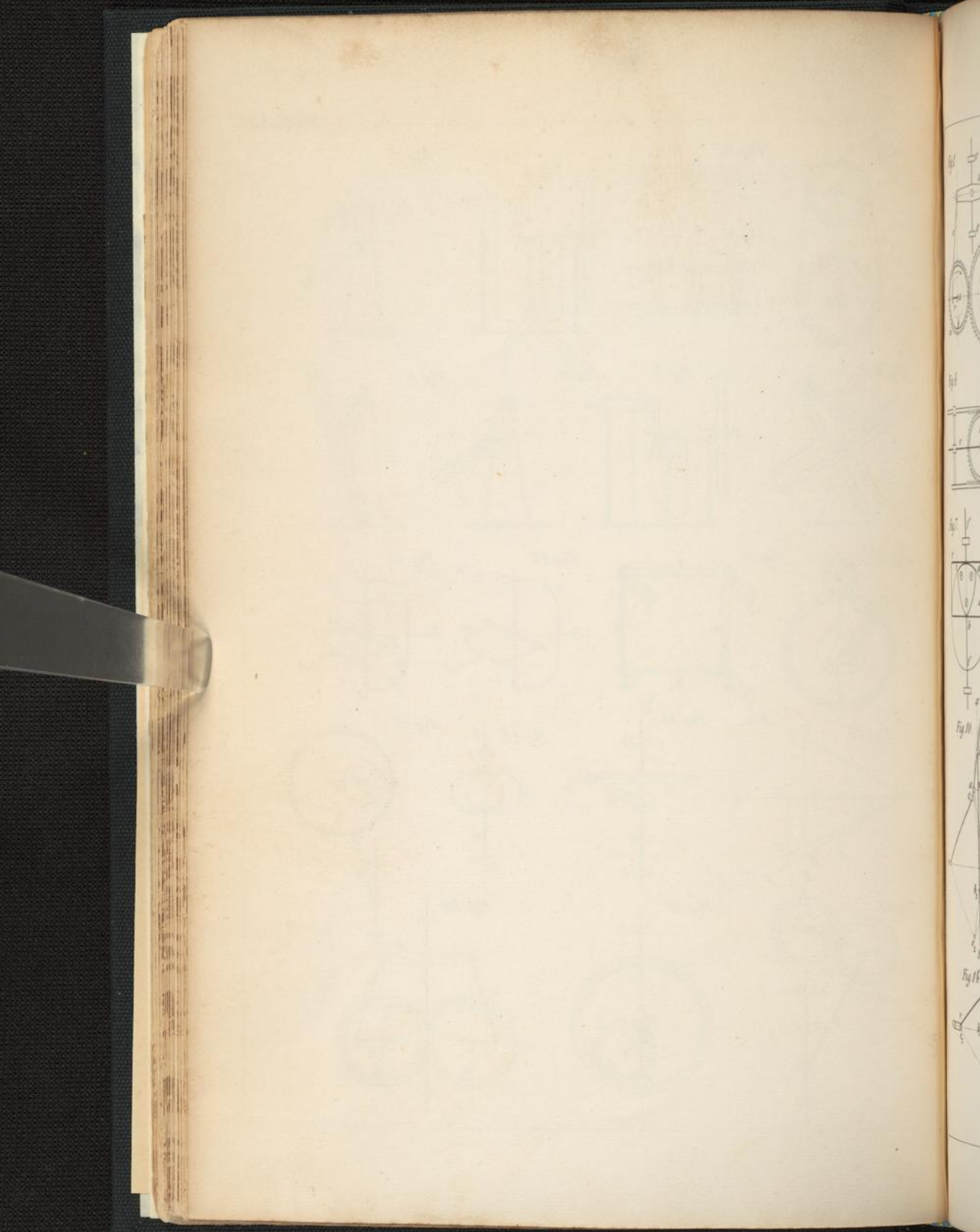


Fig. 20.





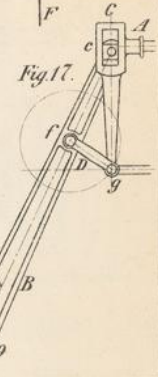
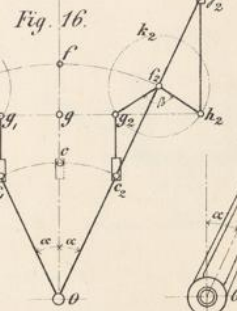
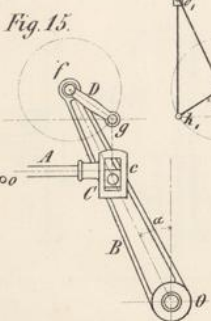
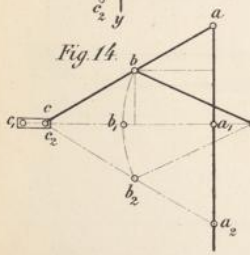
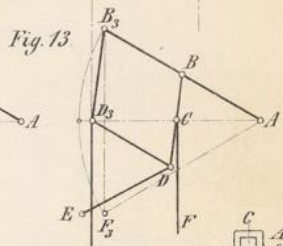
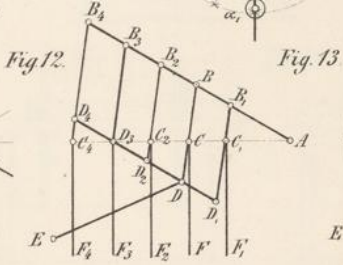
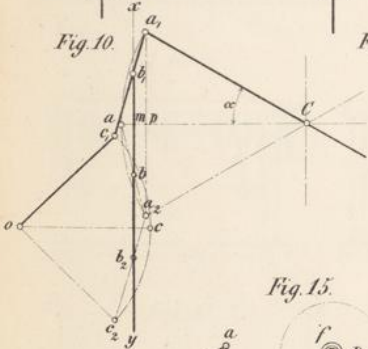
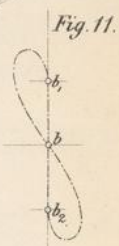
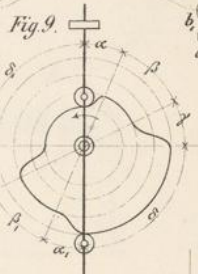
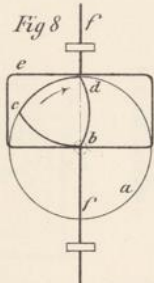
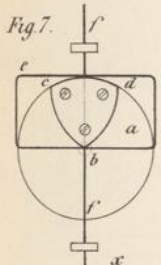
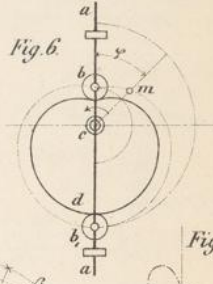
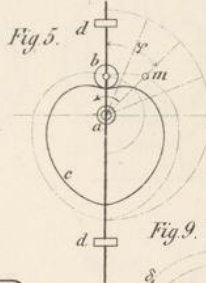
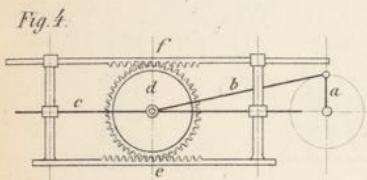
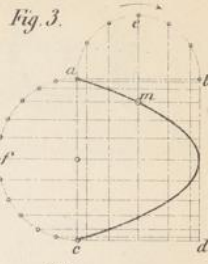
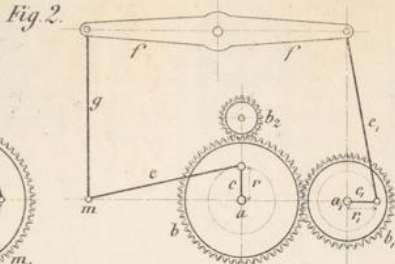
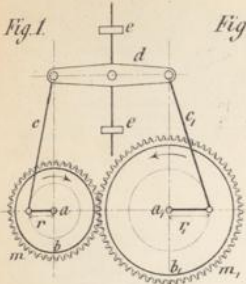


Fig. 1.

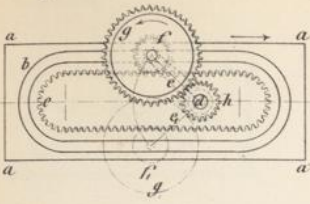


Fig. 2.

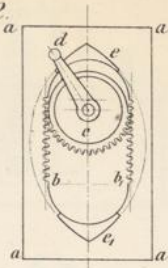


Fig. 3.

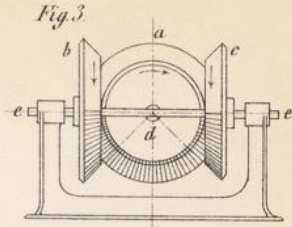


Fig. 4.

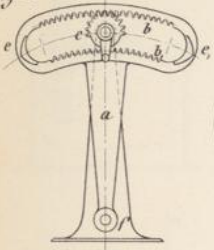


Fig. 5.

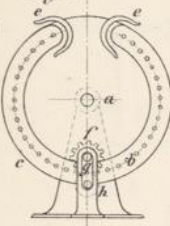


Fig. 6.

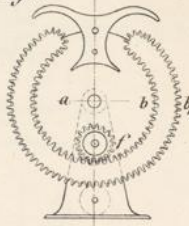


Fig. 7.

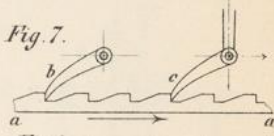


Fig. 8.



Fig. 9.

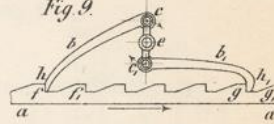


Fig. 10.

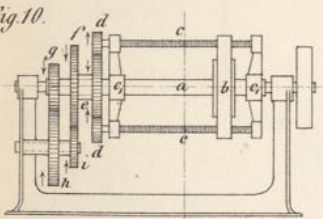


Fig. 11.

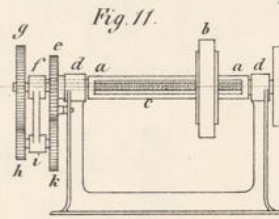


Fig. 12.

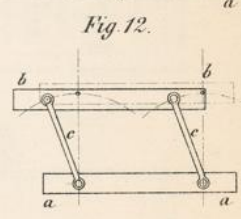


Fig. 14.

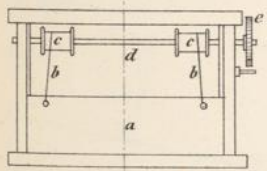


Fig. 15.

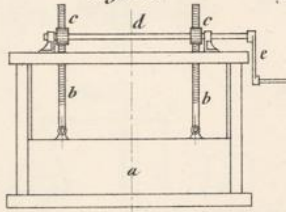


Fig. 16.

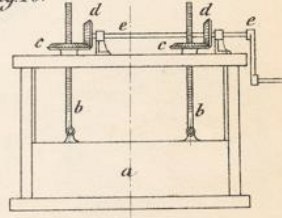


Fig. 13.

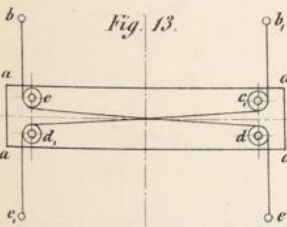


Fig. 17.

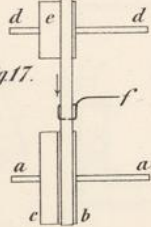
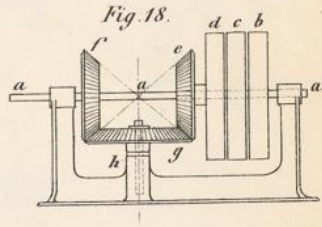


Fig. 18.



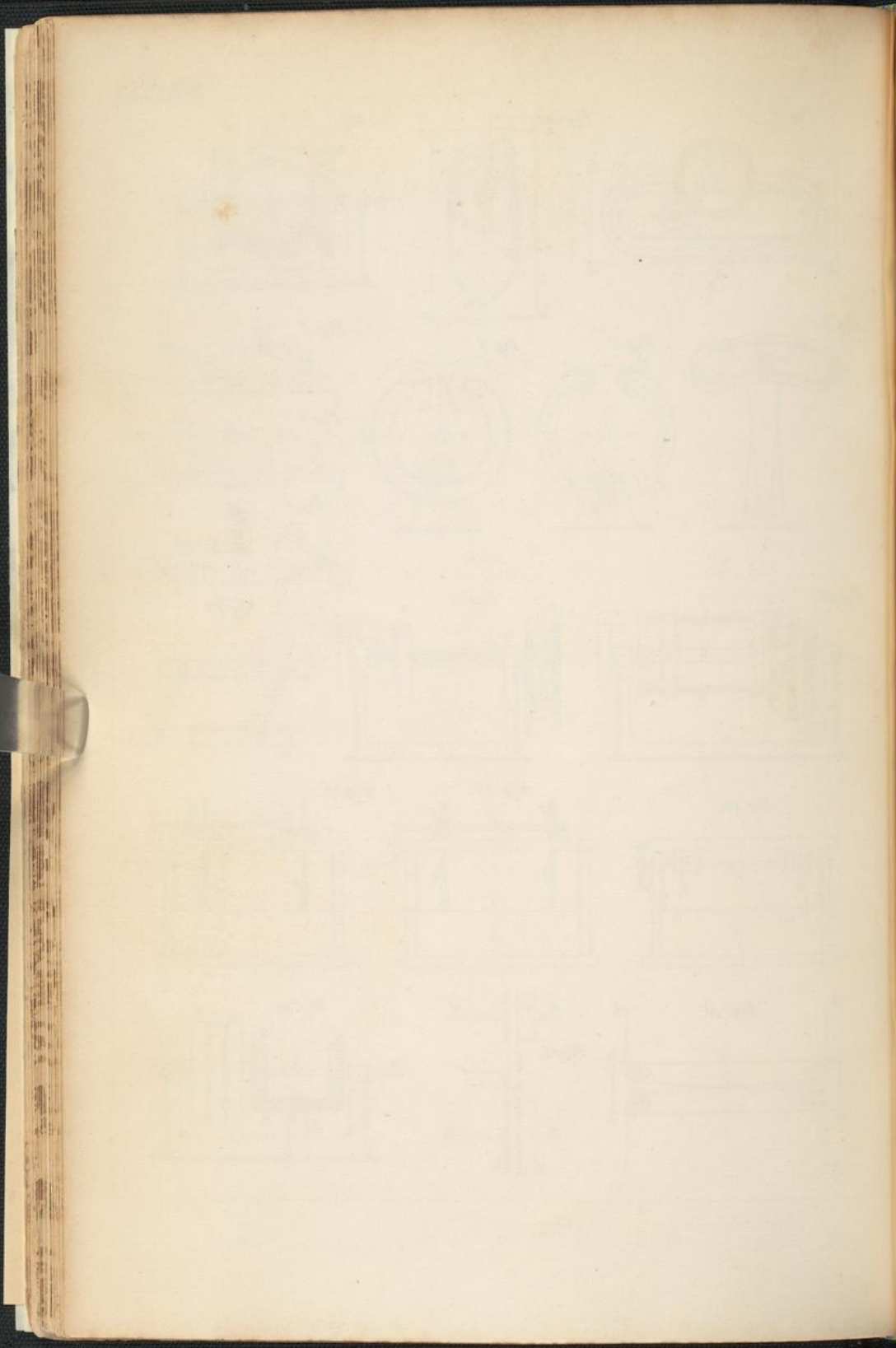


Fig. 1.

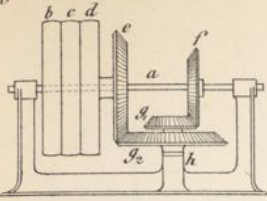


Fig. 2.

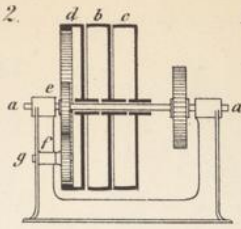


Fig. 3.

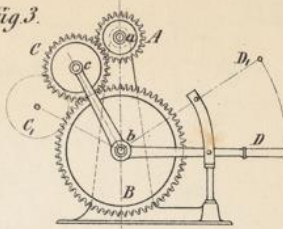


Fig. 4.

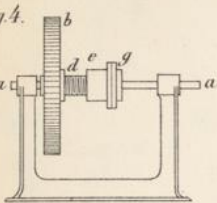


Fig. 5.

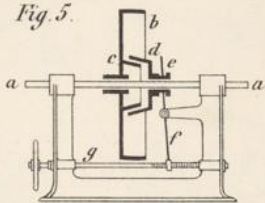


Fig. 6.

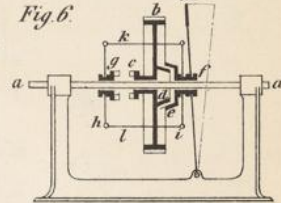


Fig. 7.

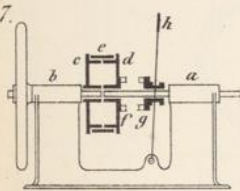


Fig. 8.

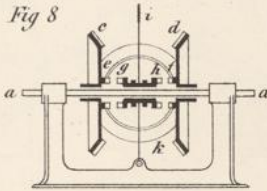


Fig. 9.

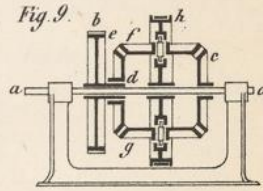


Fig. 10.

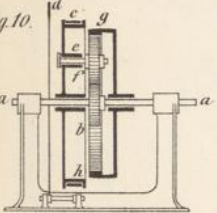


Fig. 11.

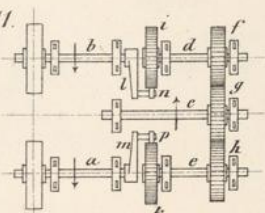


Fig. 12.

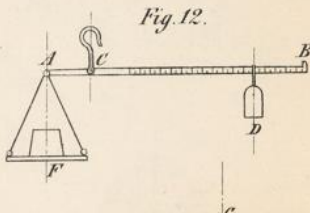


Fig. 13.

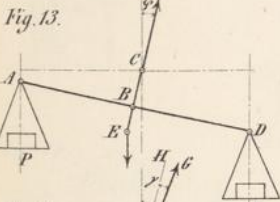


Fig. 15.

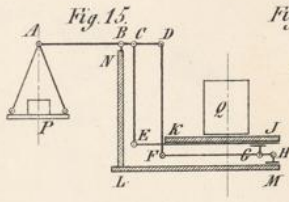


Fig. 17.

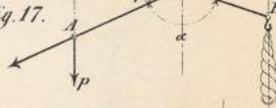


Fig. 14.

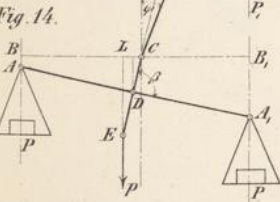


Fig. 16.

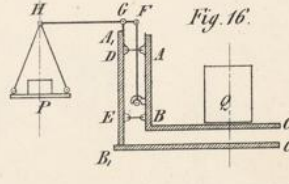
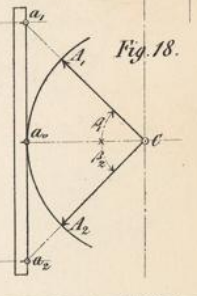


Fig. 18.



Lith. Anst. v. L. Weisendörfer, Carlruehe

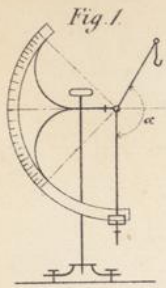


Fig. 1.

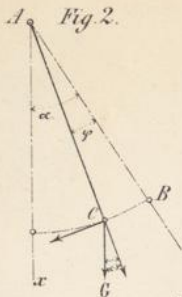


Fig. 2.

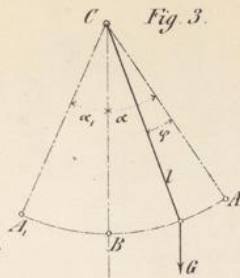


Fig. 3.

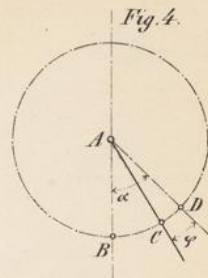


Fig. 4.

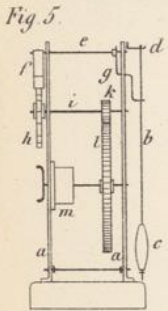


Fig. 5.

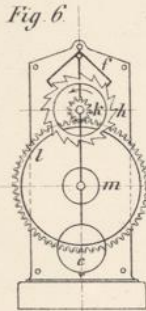


Fig. 6.



Fig. 7.

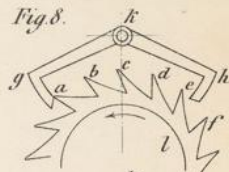


Fig. 8.



Fig. 9.

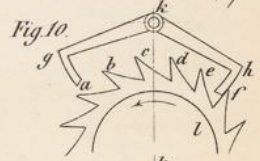


Fig. 10.

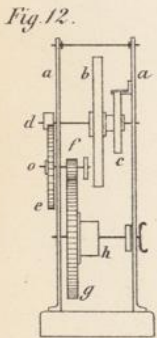


Fig. 12.

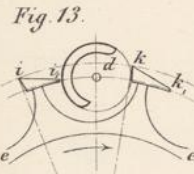


Fig. 13.

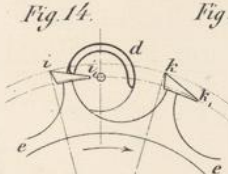


Fig. 14.



Fig. 11.

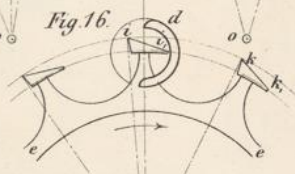


Fig. 16.

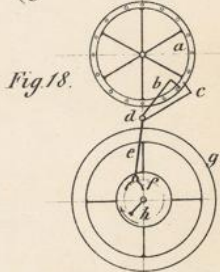


Fig. 18.

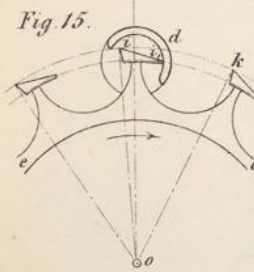


Fig. 15.

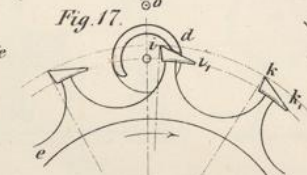


Fig. 17.

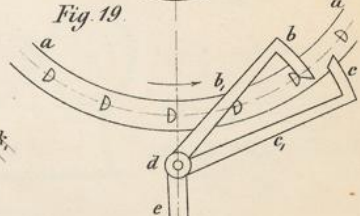
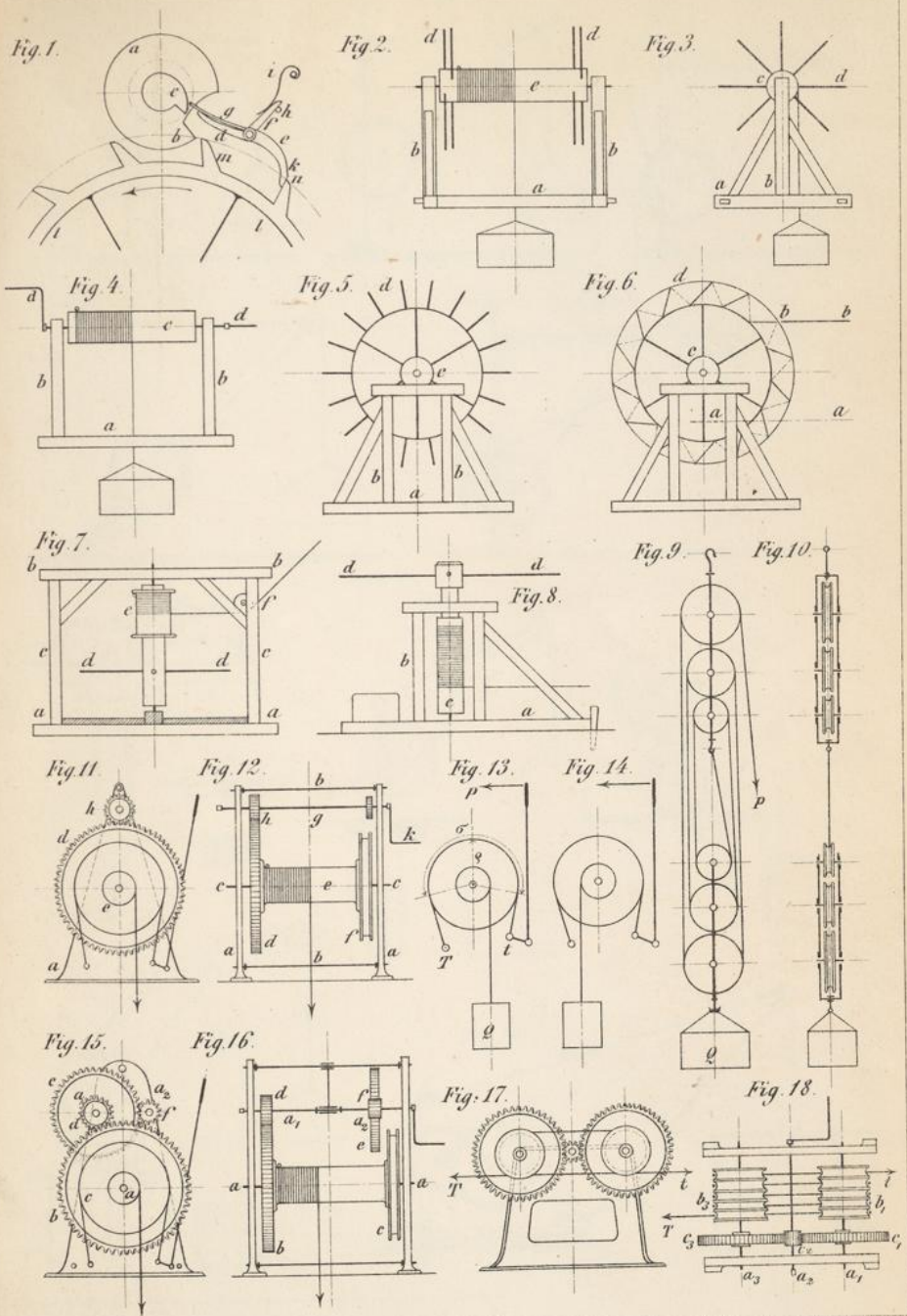


Fig. 19.



Lith. v. I. Geisendorfer, Carlstadt

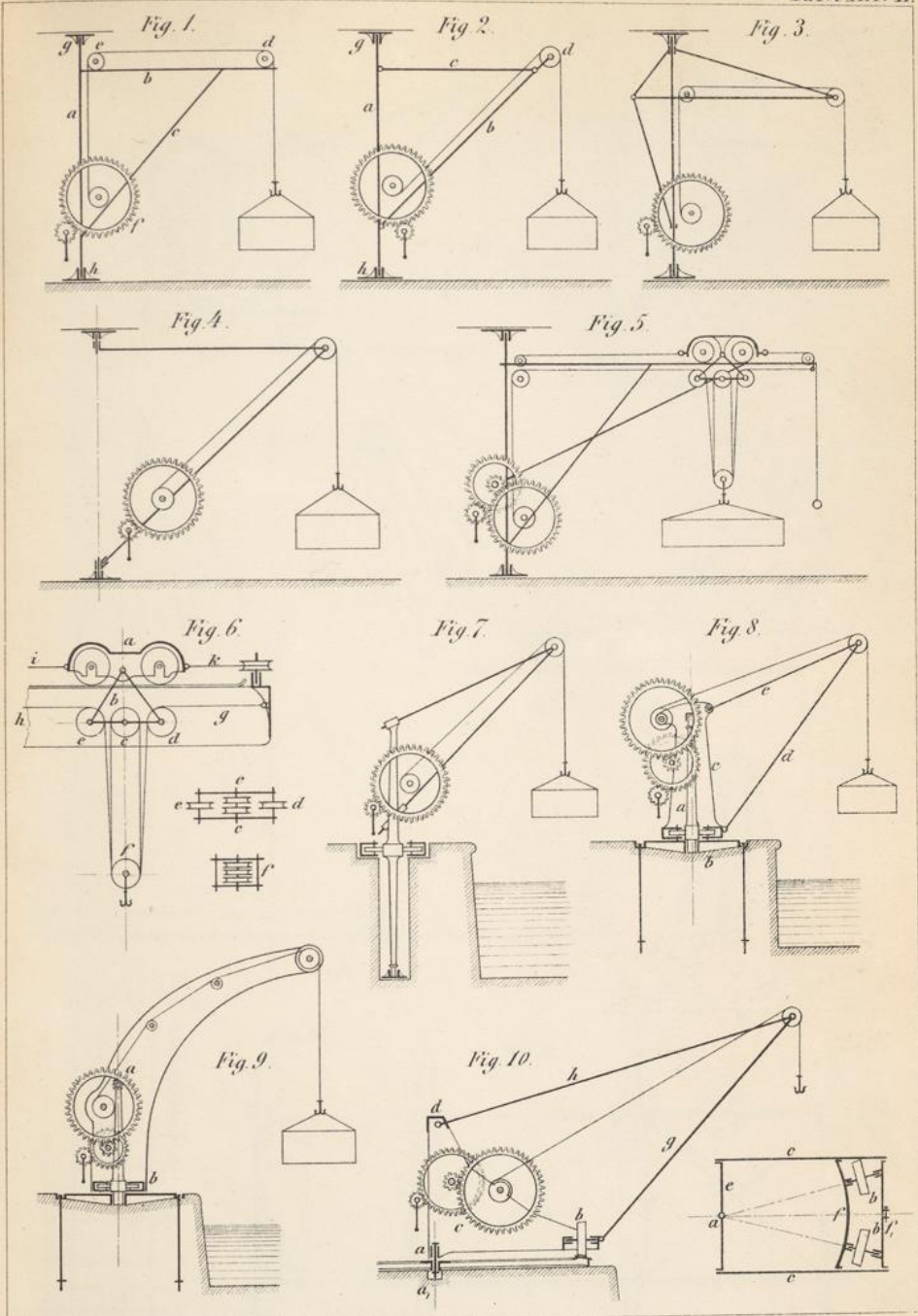


Fig. 1.

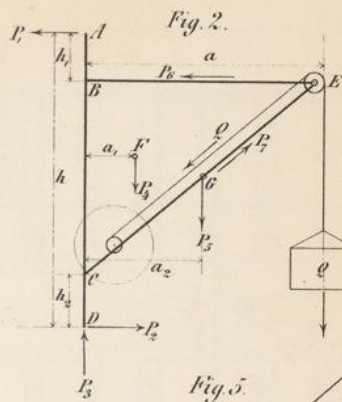
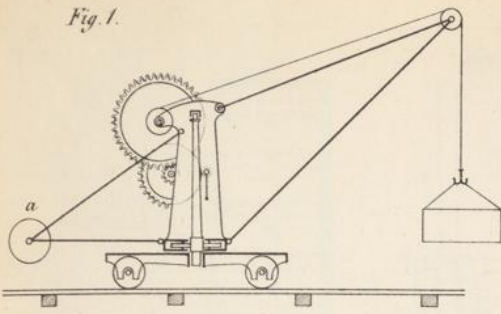


Fig. 3.

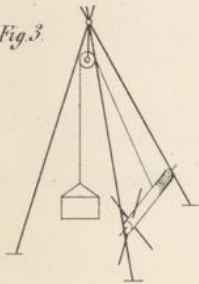


Fig. 4.

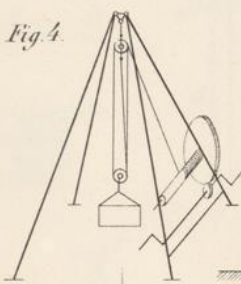


Fig. 5.

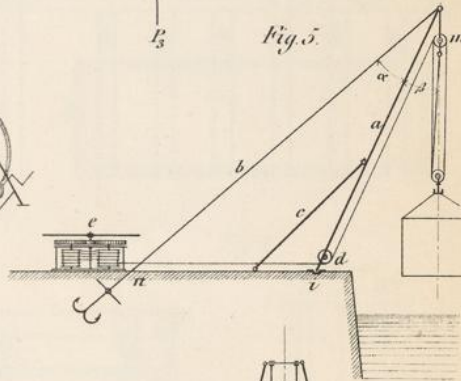


Fig. 7.

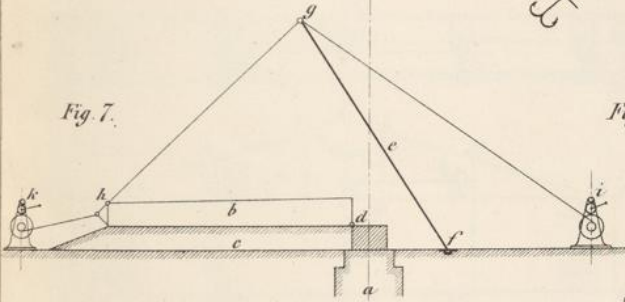


Fig. 6.

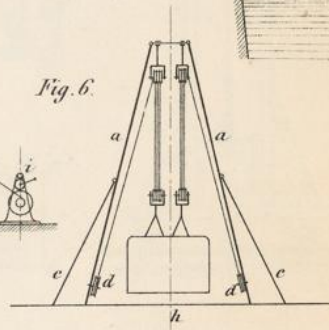


Fig. 8.

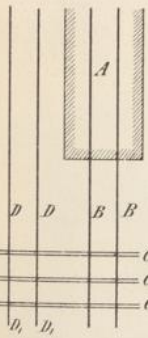


Fig. 10.

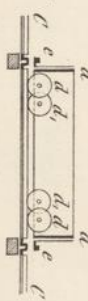
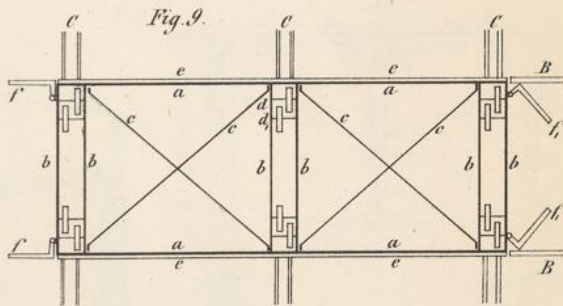


Fig. 9.



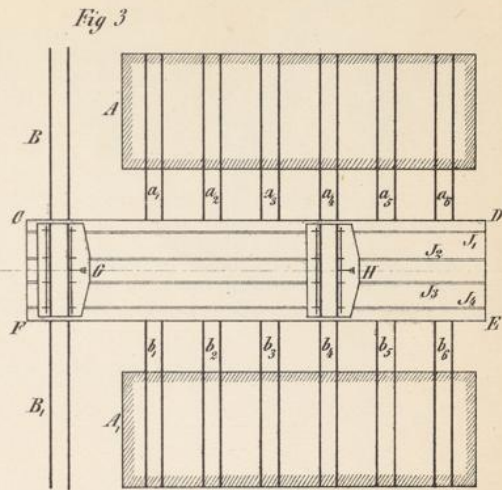
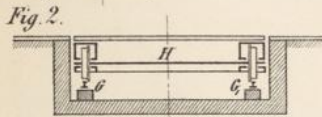
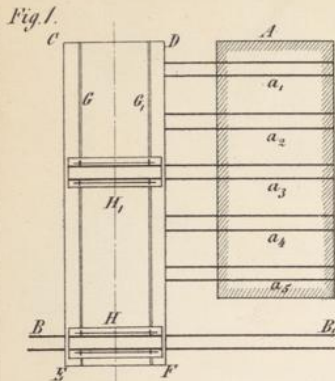


Fig. 4.

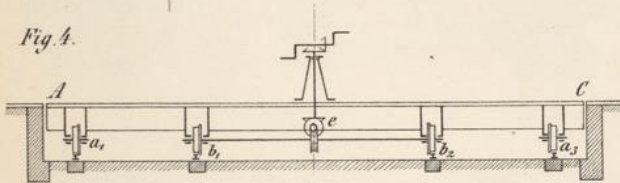


Fig. 5.

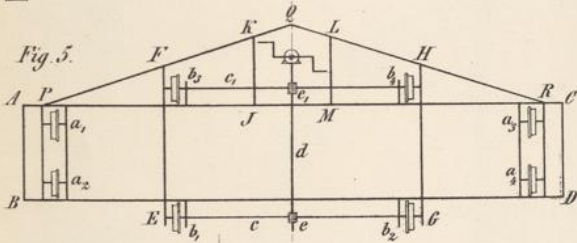


Fig. 8.

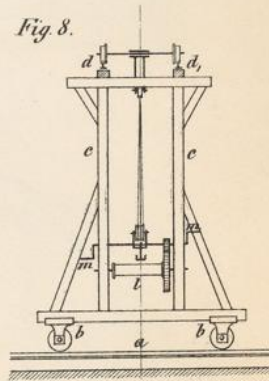


Fig. 6.

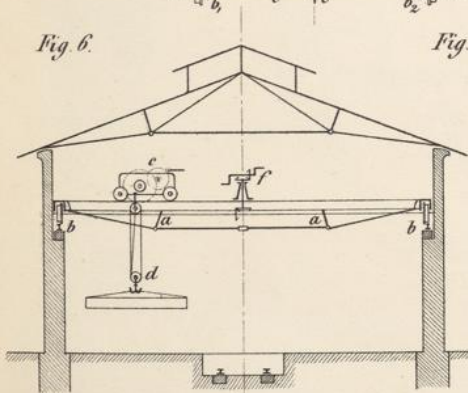
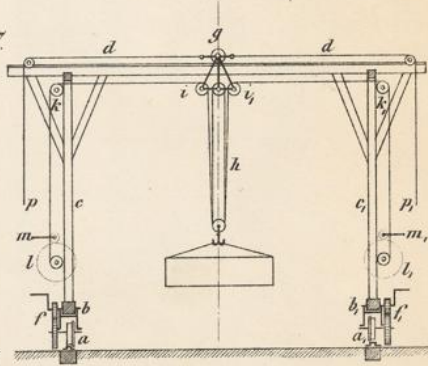


Fig. 7.



Lith. v. L. Heisenhöfer, Karlsruhe

Fig. 1.

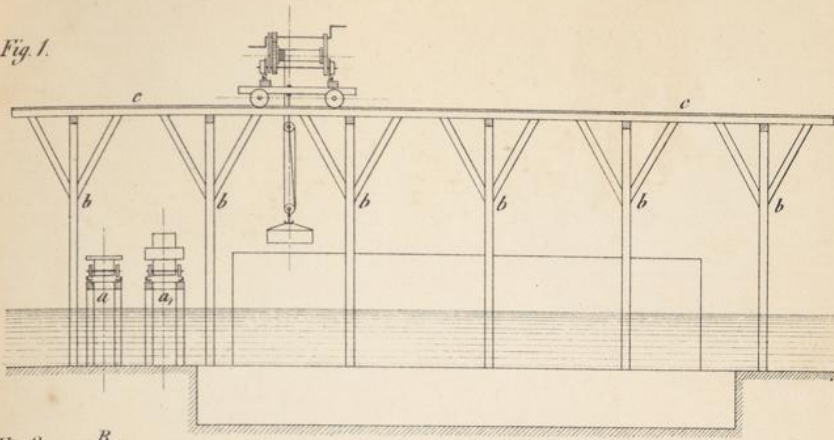


Fig. 2.

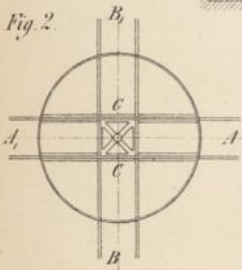


Fig. 3.

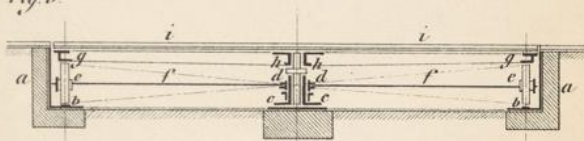
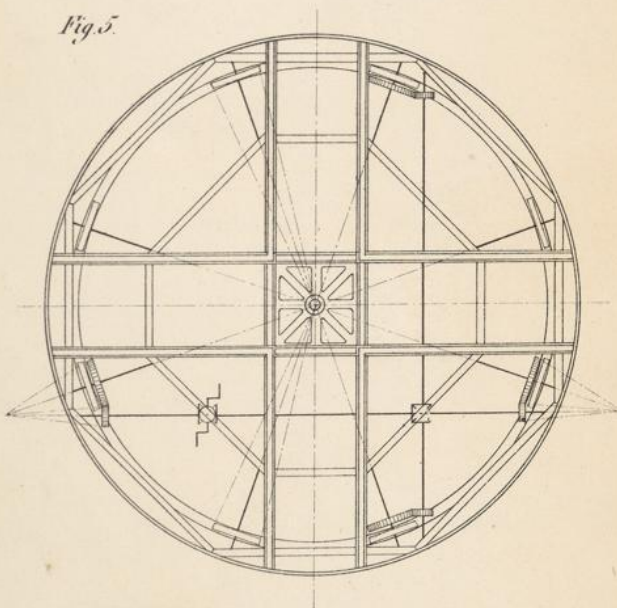


Fig. 4.



Fig. 5.



Lith. v. L. Geisendorfer, Durlach.

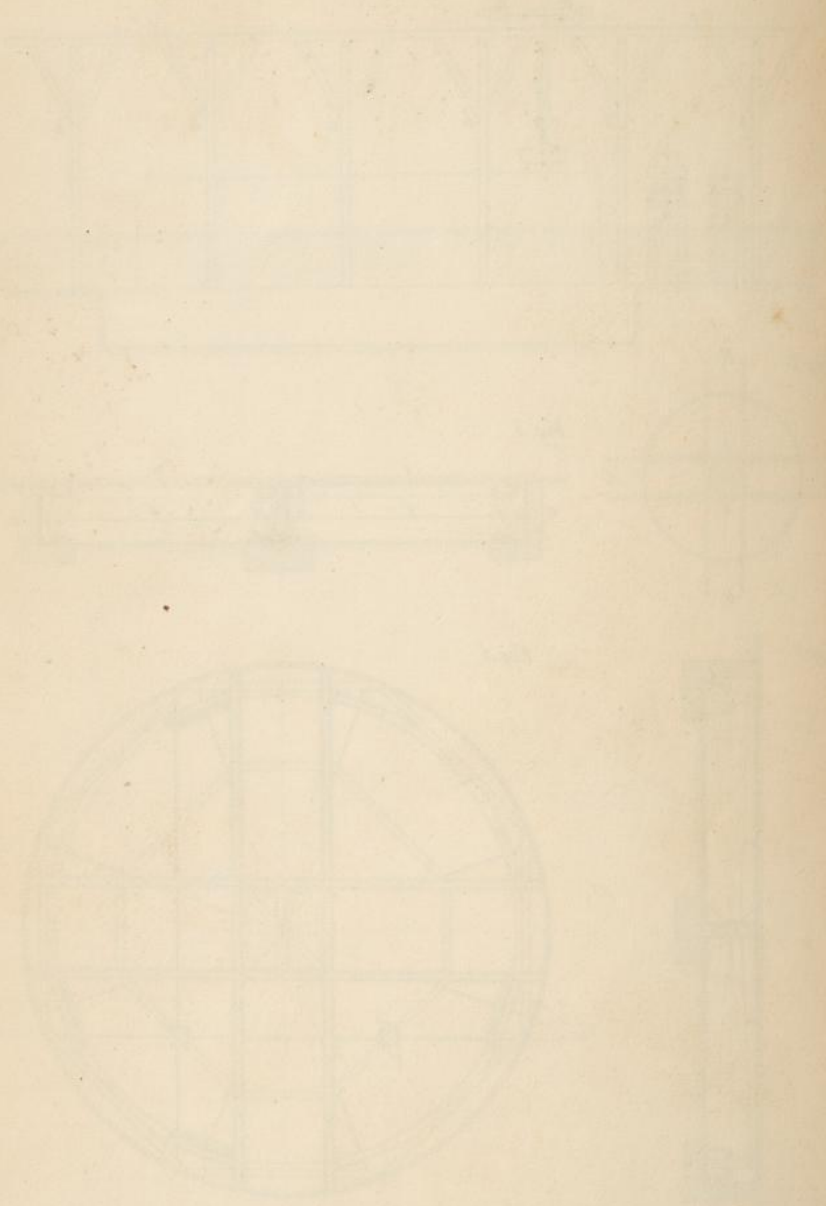




Fig. 1.

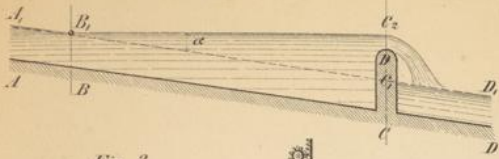


Fig. 2.

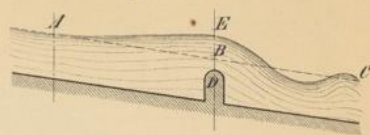


Fig. 3.

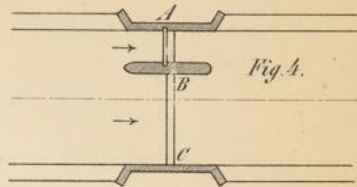
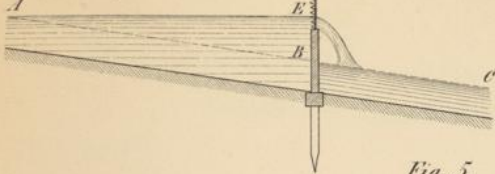


Fig. 5.

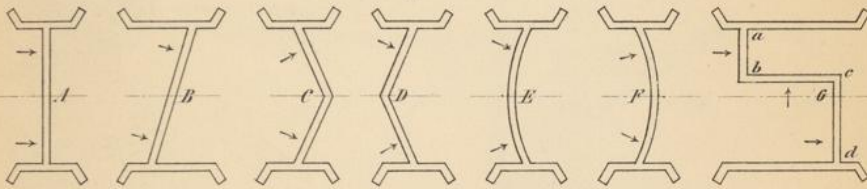


Fig. 6.

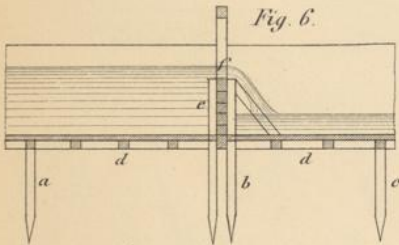


Fig. 7.

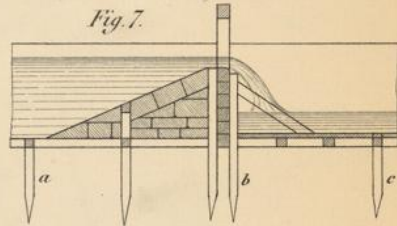


Fig. 10.

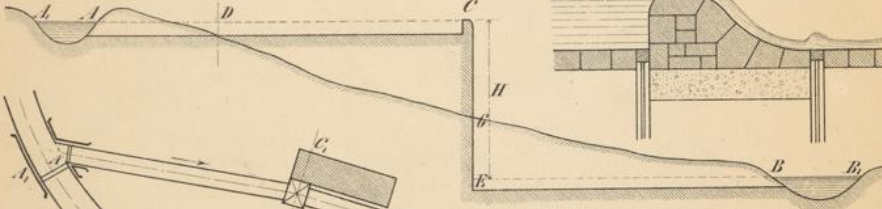


Fig. 8.

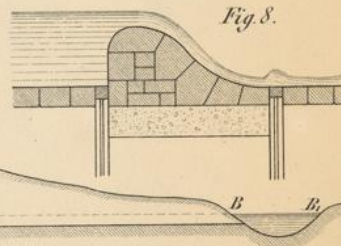
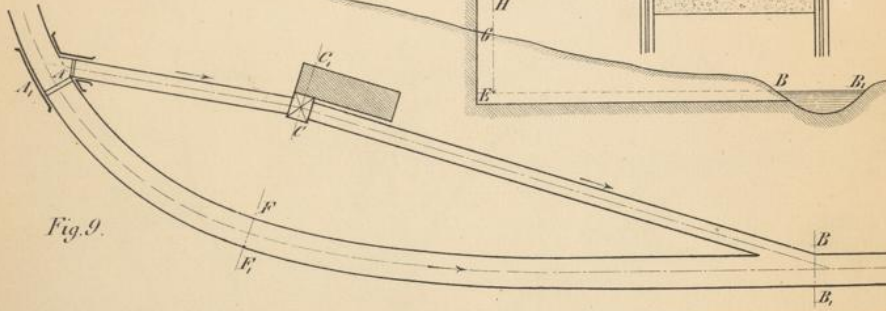
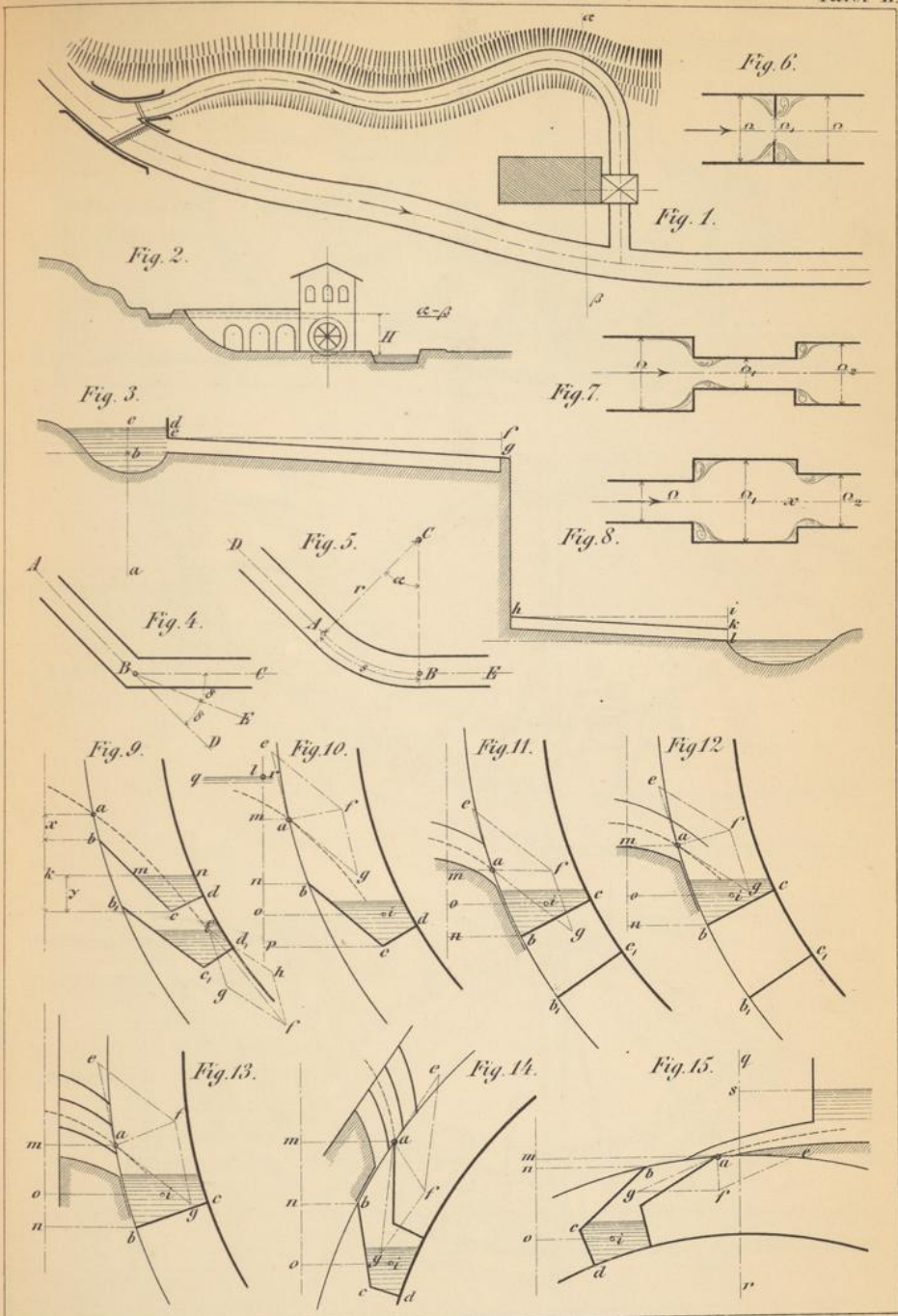


Fig. 9.



Lehr. v. I. Göttschäcker, Karlsruhe



Arch. v. I. Gessensdorfer, Karlsruhe.

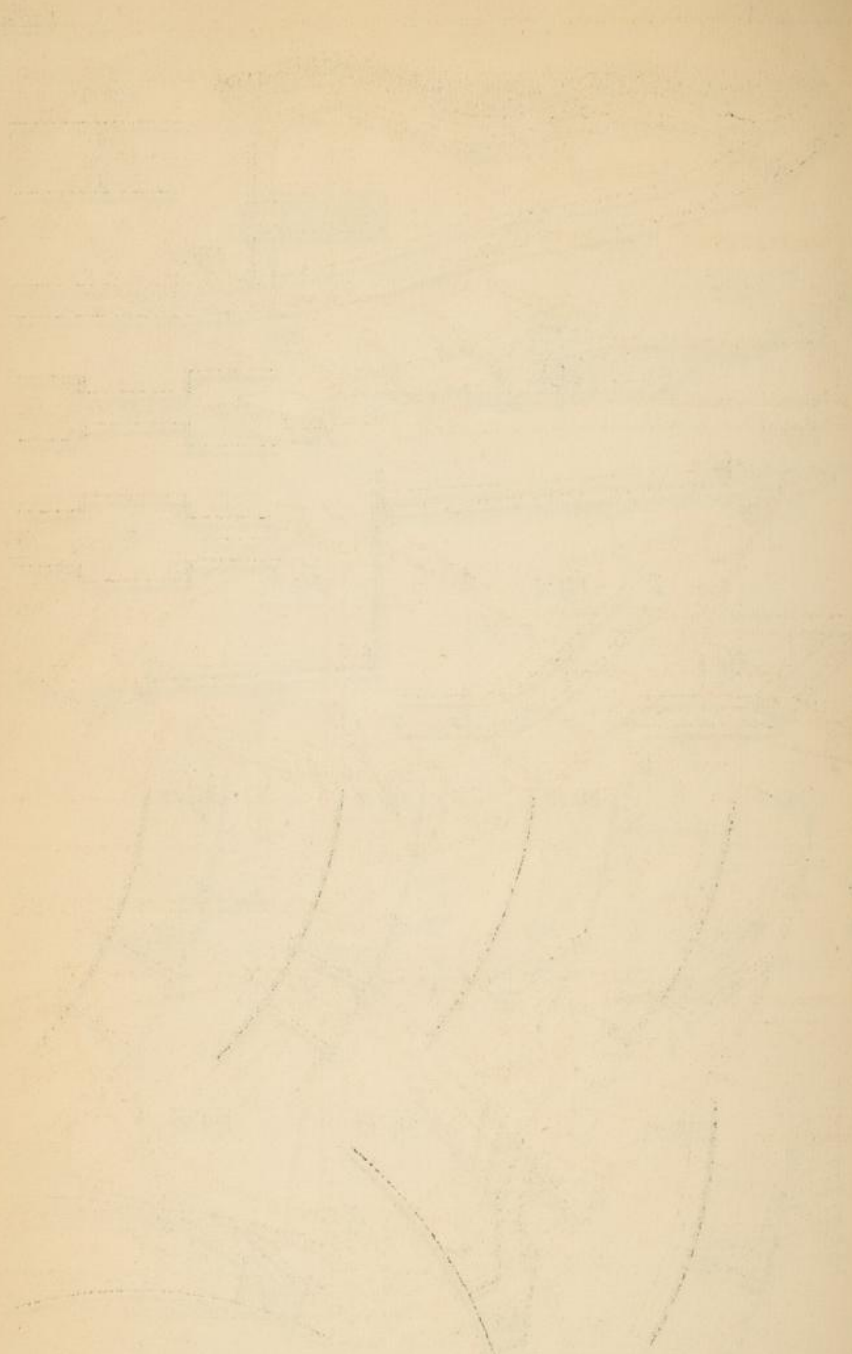


Fig. 1.

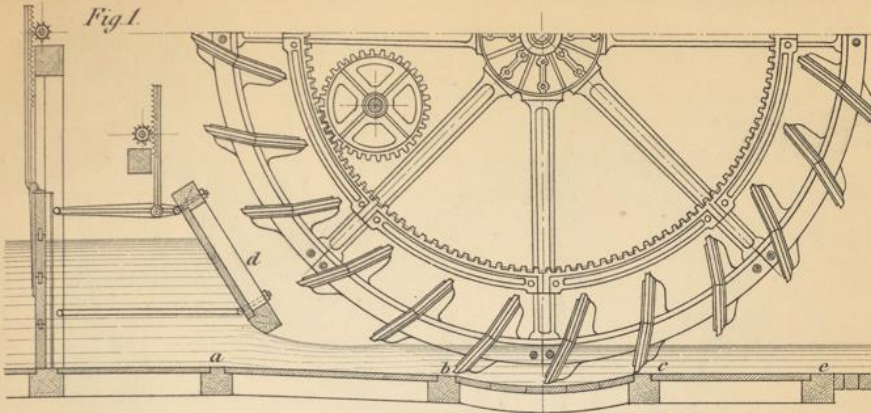


Fig. 2.

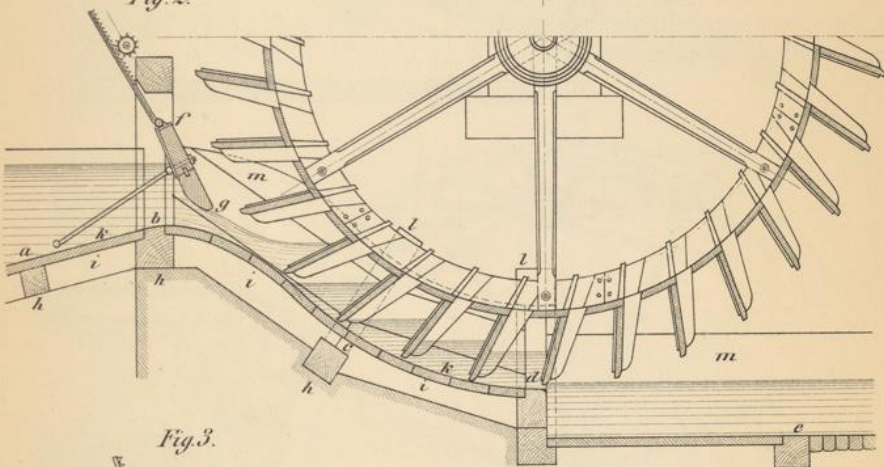
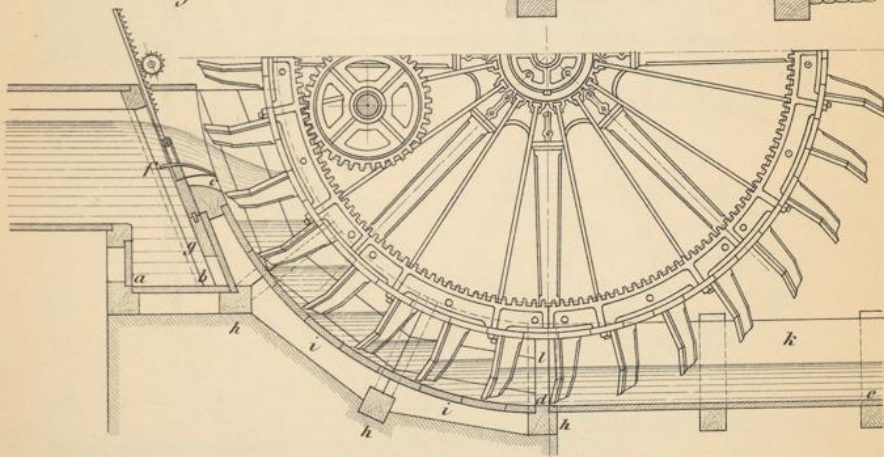


Fig. 3.



Lith. J. Feissendörfer, Karlsruhe

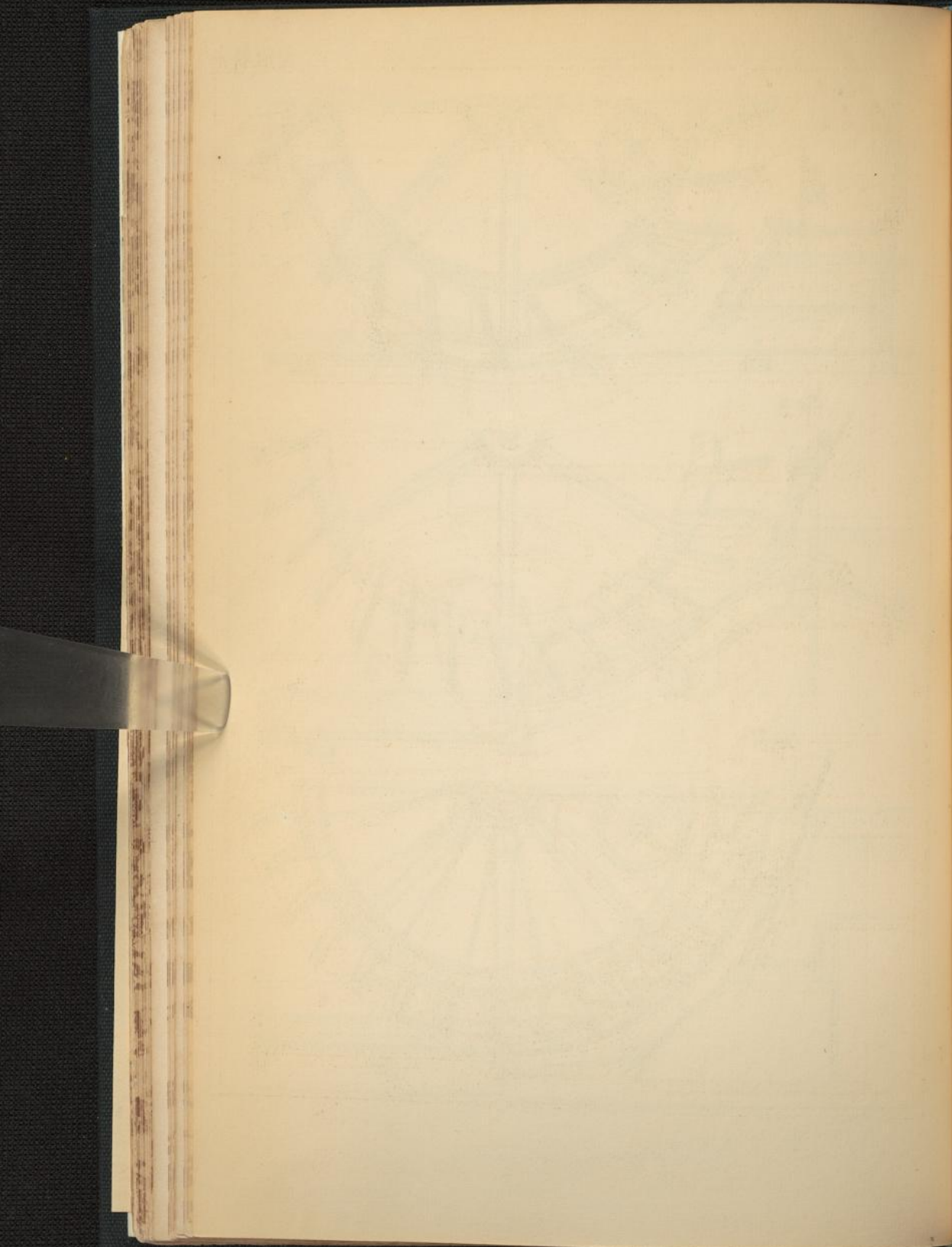


Fig. 1



Fig.



Fig. 1.

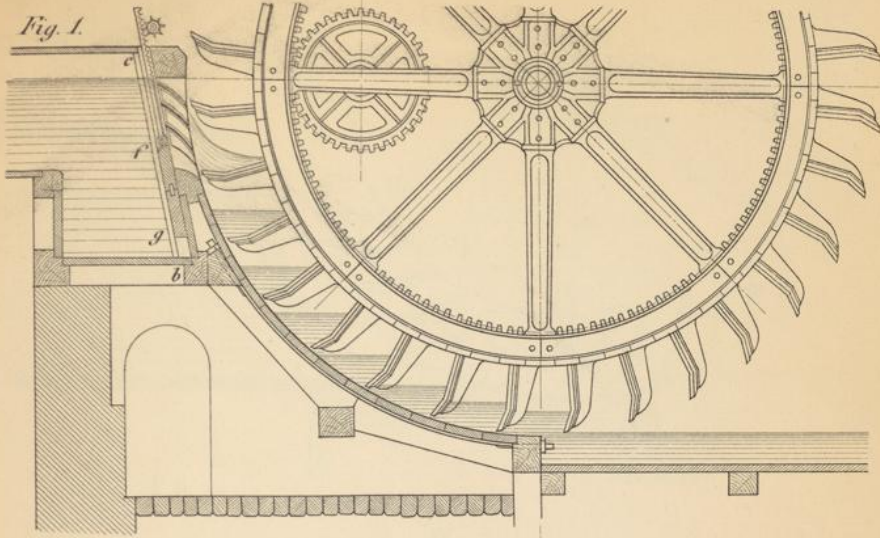
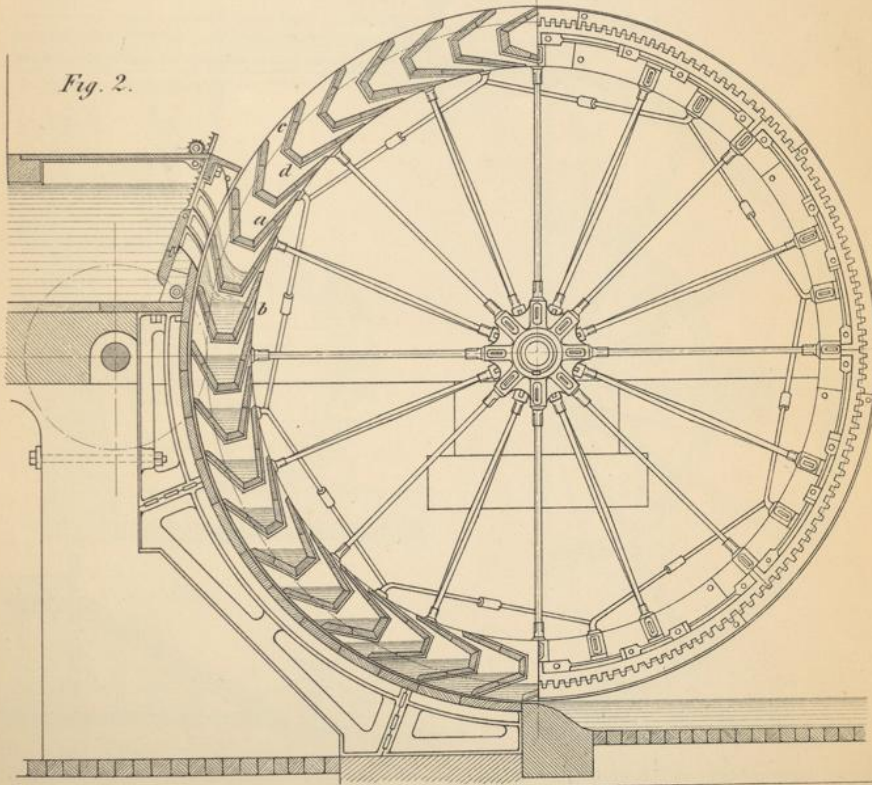


Fig. 2.



Entwurf von L. Gassen, Kempten, Carlstr. 10.

Fig. 1.

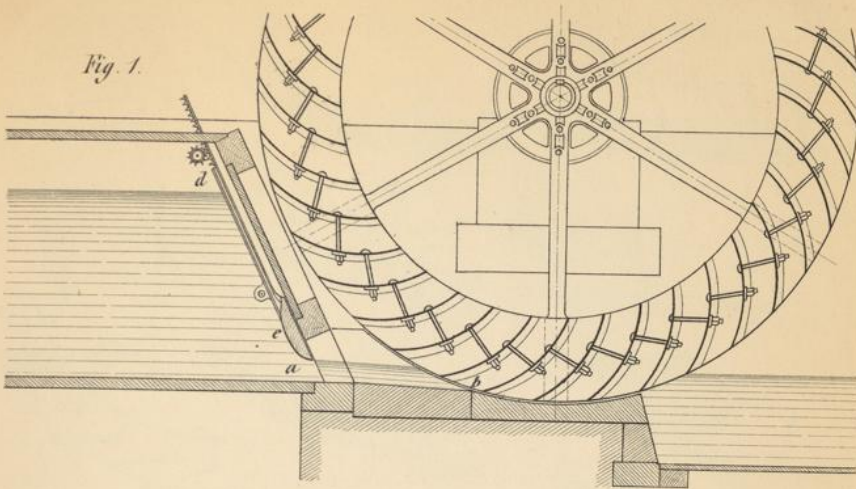


Fig. 2.

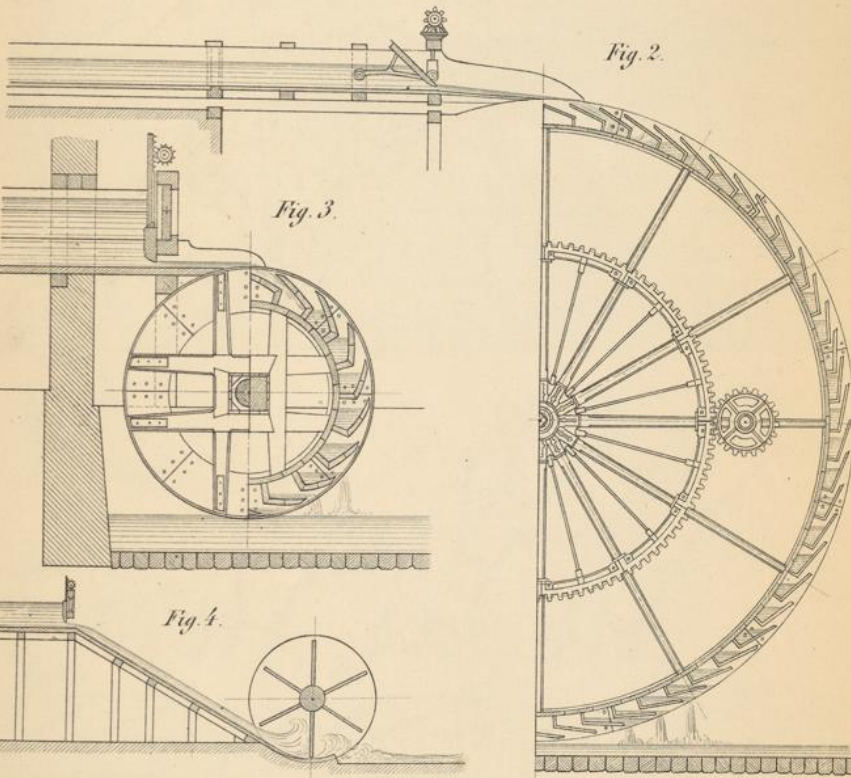


Fig. 3.

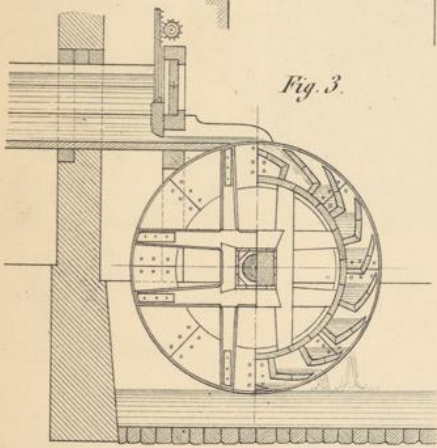
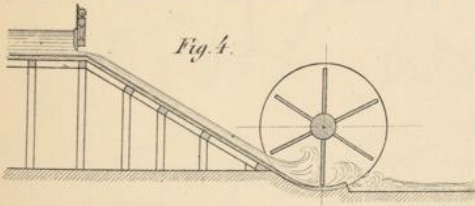
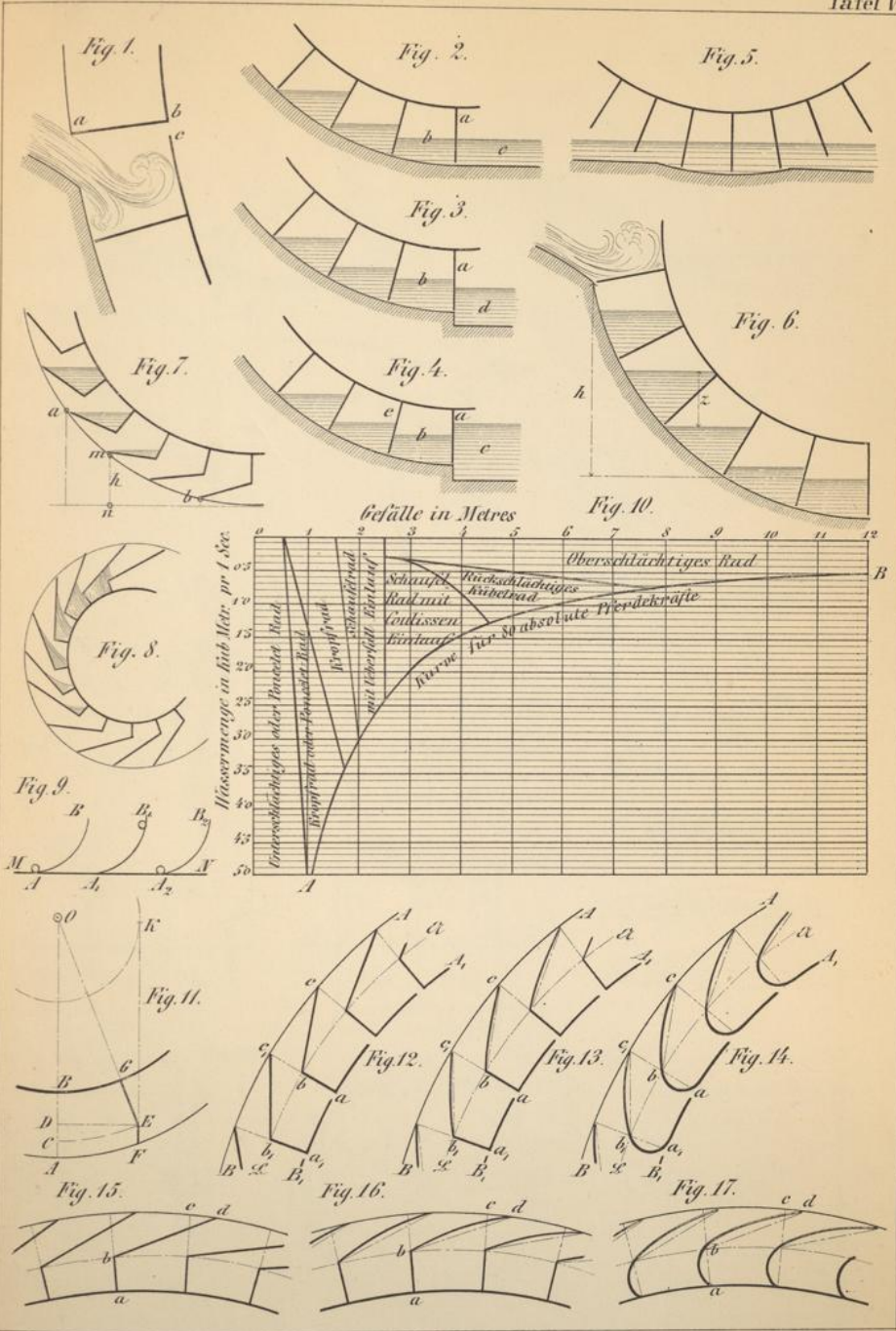


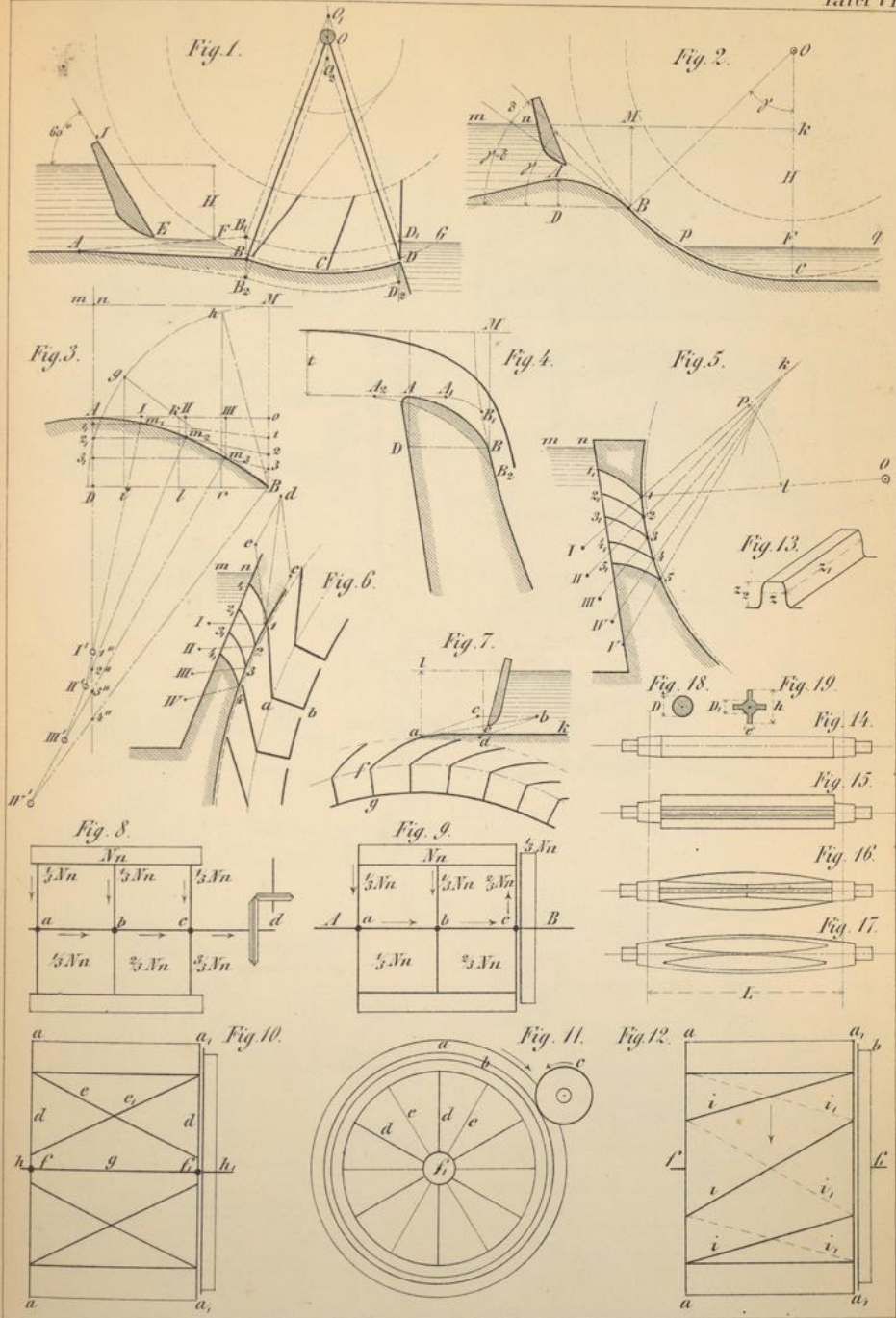
Fig. 4.



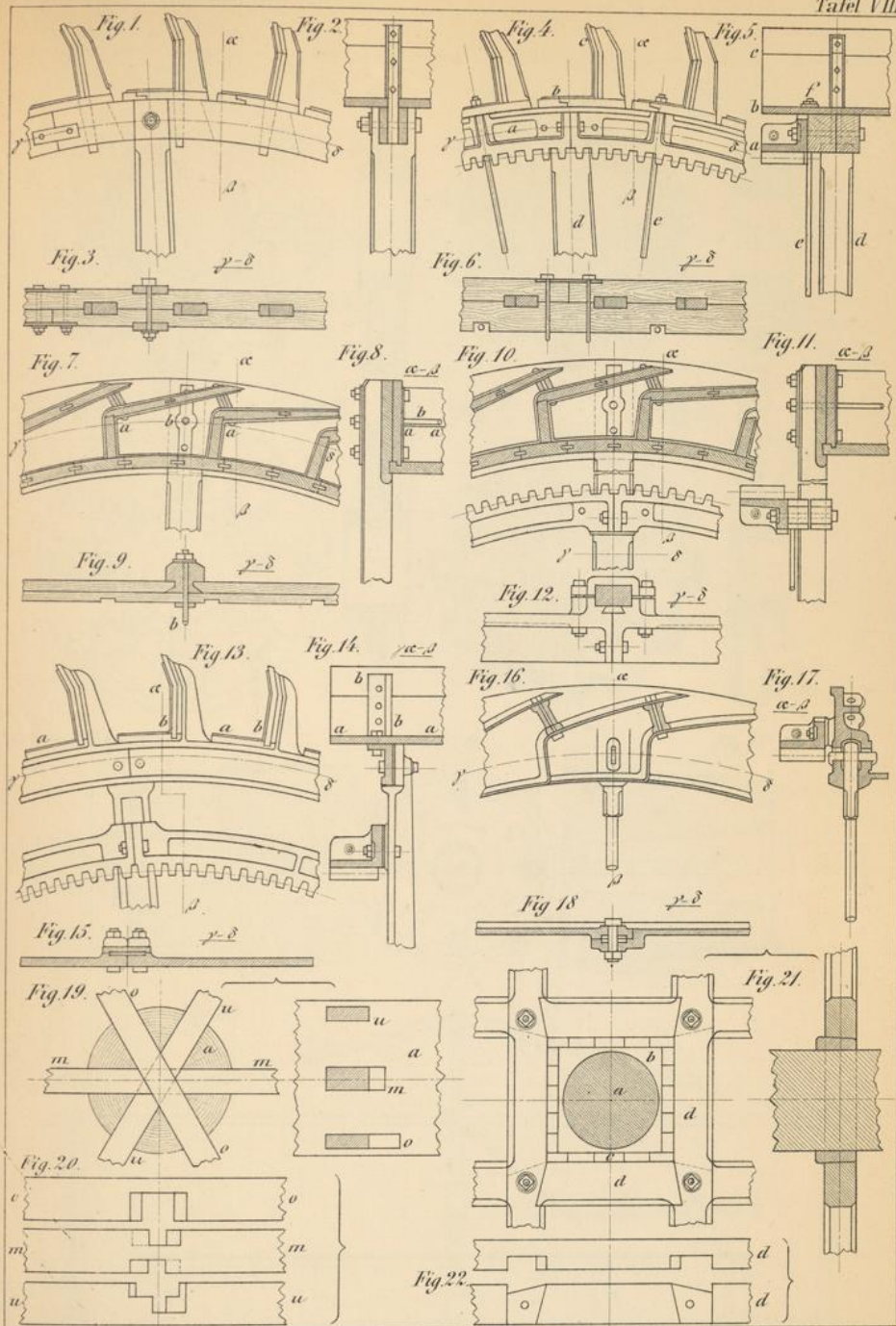
Zsch. u. L. Feisensdorfers Carthusa



Lith. v. I. Feissner in Stuttgart, Carlstr. 10



Arch. v. L. Geisensdorfer, Carlrube.



Lehr u. L. Geisendörfer's Car-Gearwerk.

Fig. 1



Fig. 2

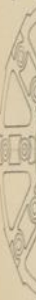


Fig. 3

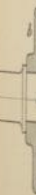


Fig. 4



Fig. 1.

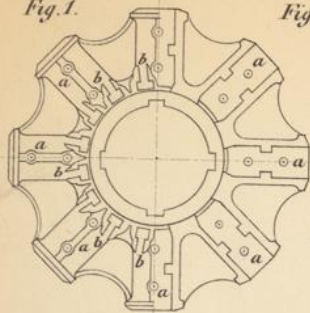


Fig. 2.

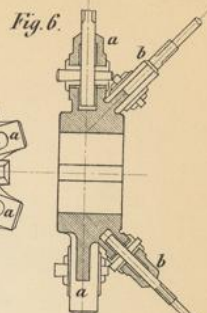
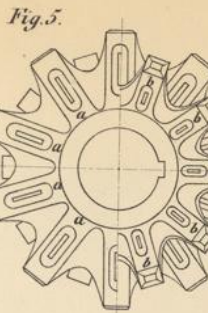
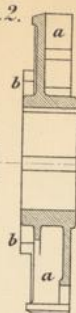


Fig. 3.

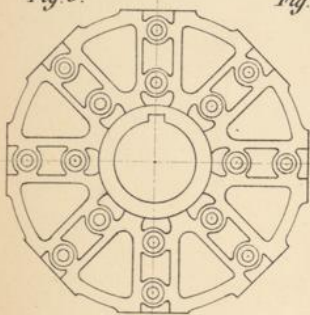


Fig. 4.

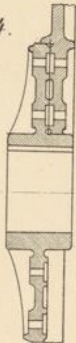


Fig. 7.

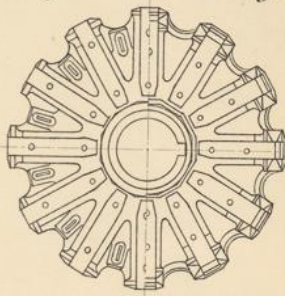


Fig. 8.

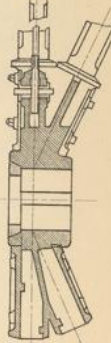


Fig. 9.

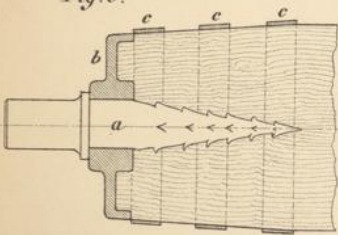


Fig. 11.

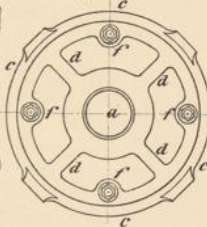


Fig. 10.

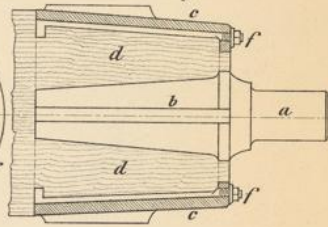
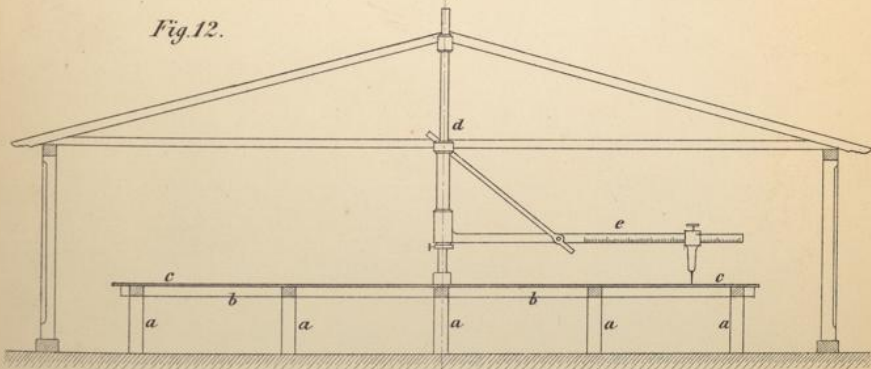


Fig. 12.



Lith. v. L. Geisenhörter, Karlsruhe.

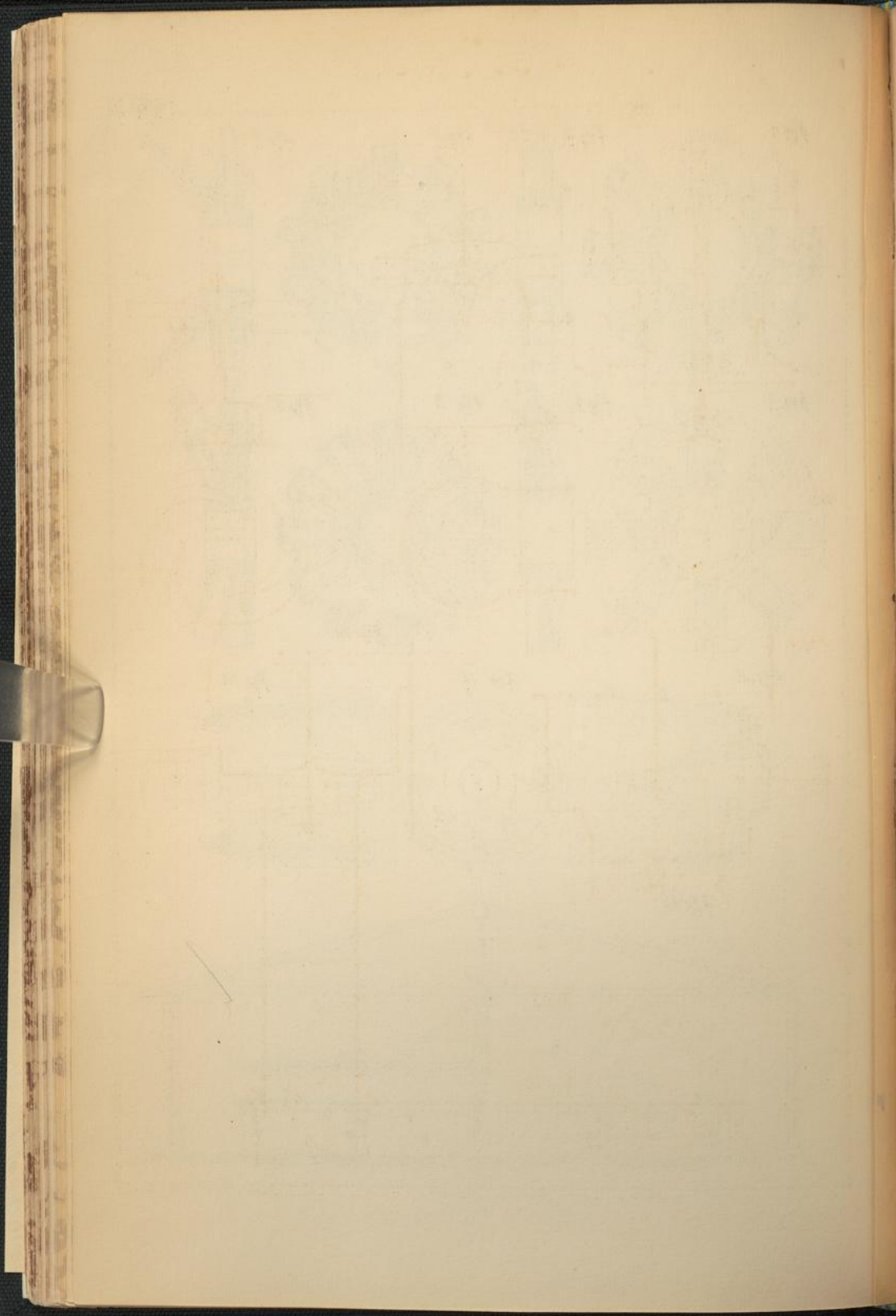


Fig. 1.

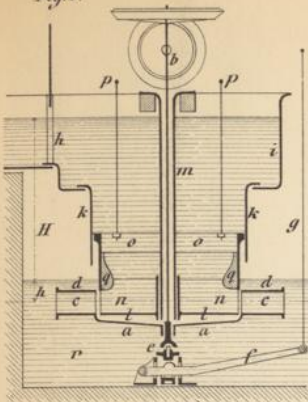


Fig. 3.

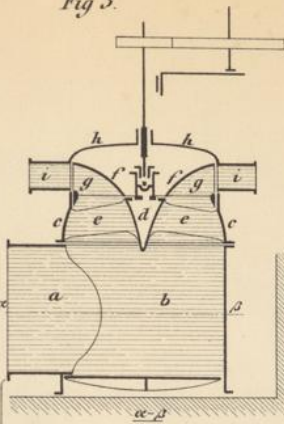


Fig. 4.

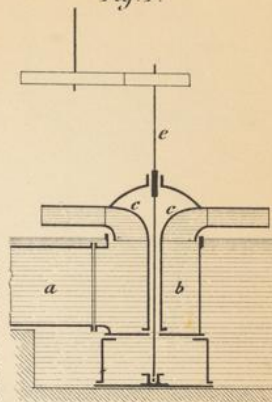


Fig. 2.

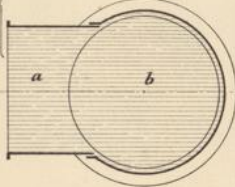
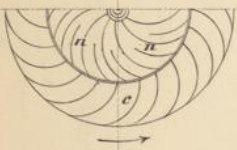


Fig. 5.

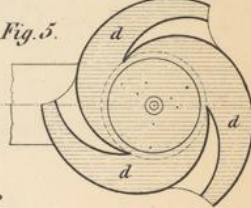


Fig. 6.

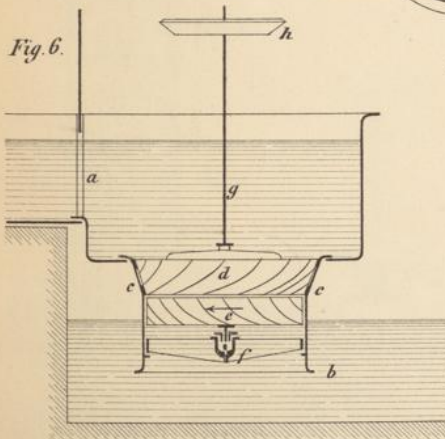


Fig. 8.

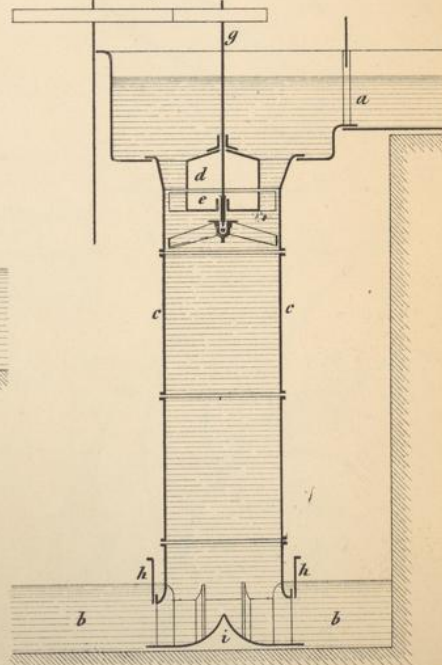
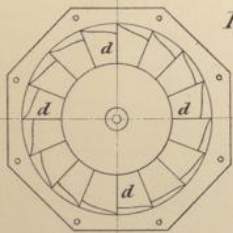
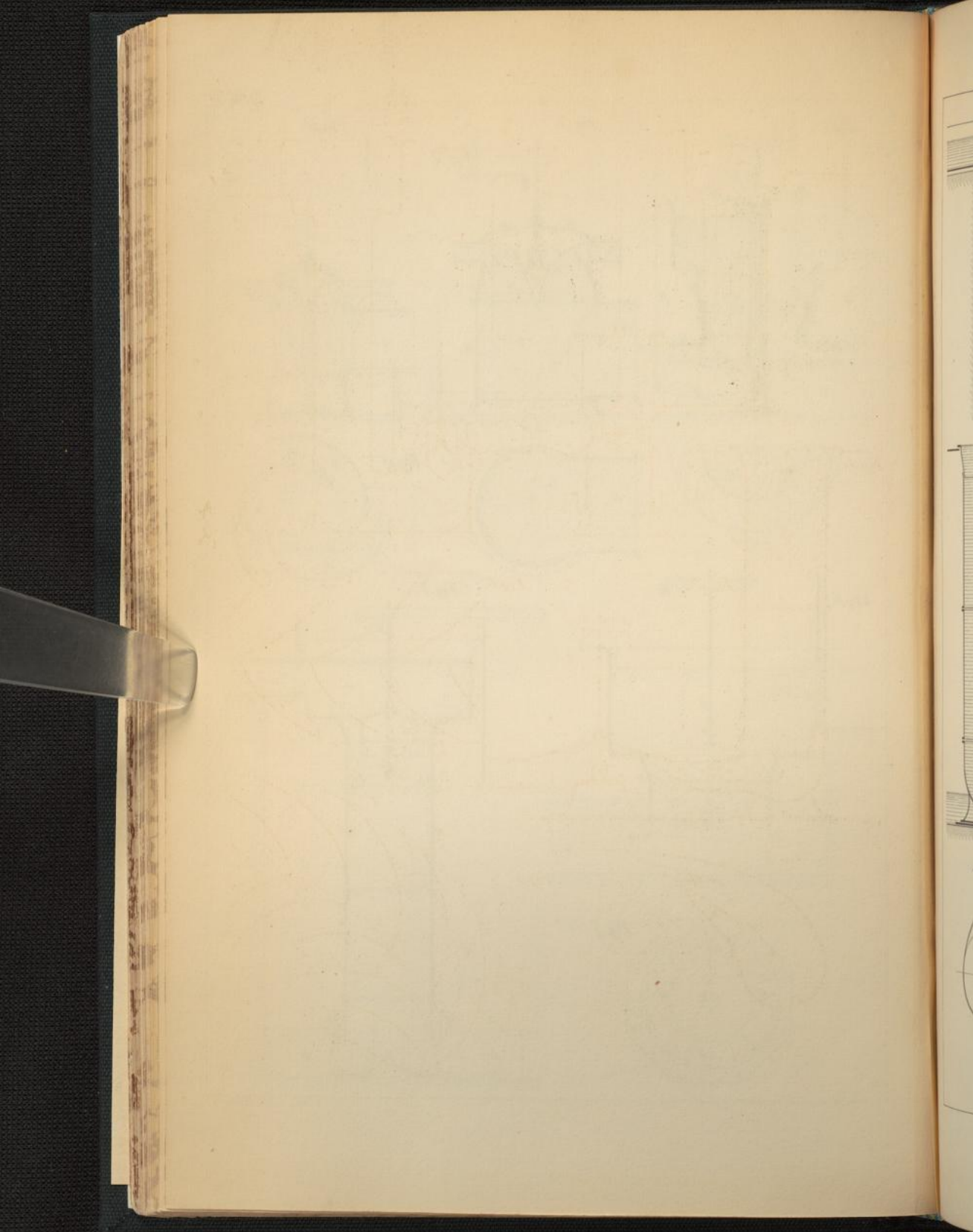
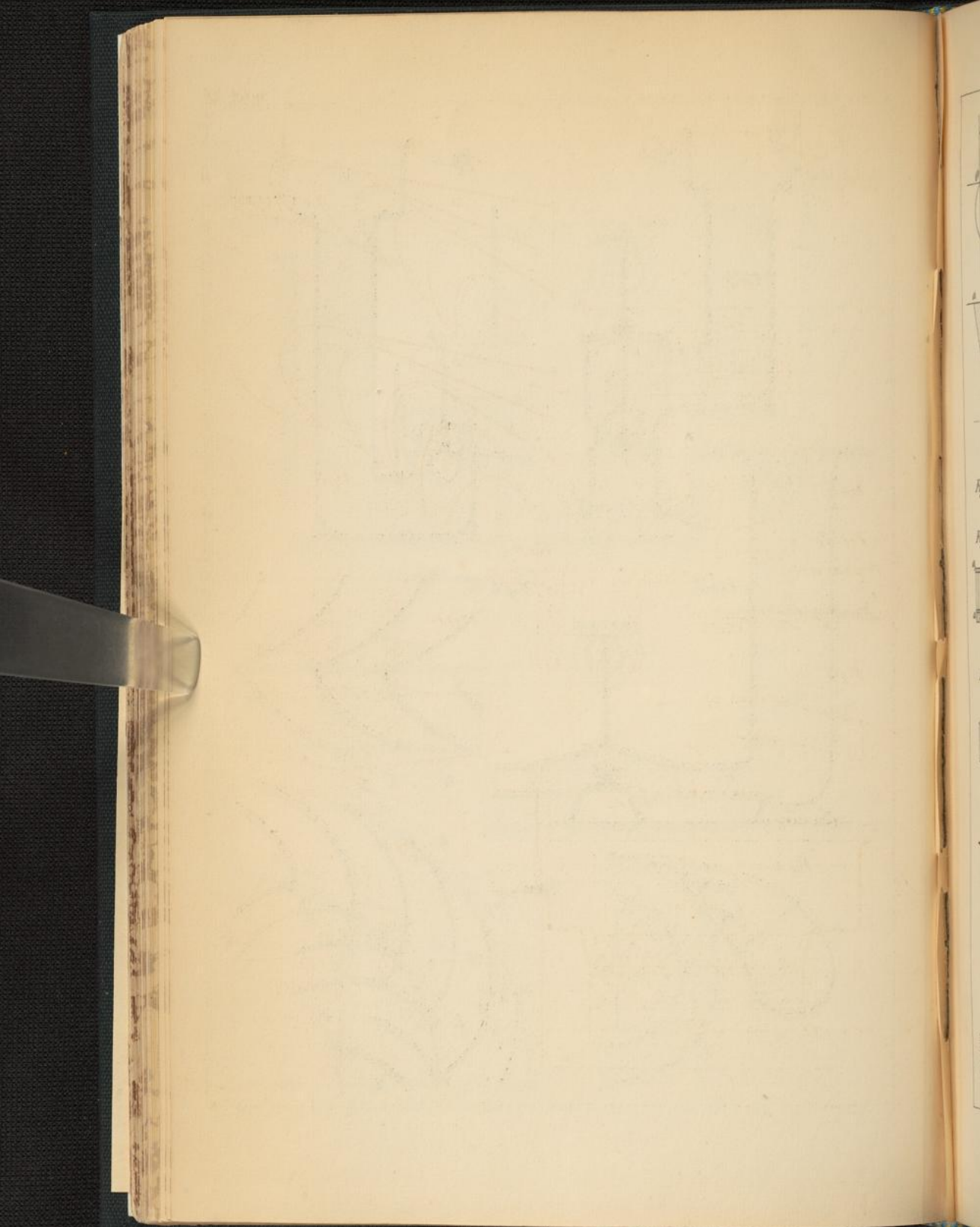


Fig. 7.



Lith. v. L. Geisenbörger, Carlsruhe





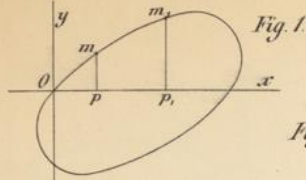


Fig. 1.

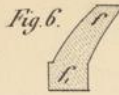


Fig. 6.

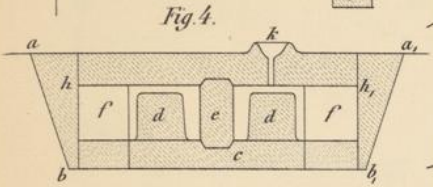


Fig. 4.

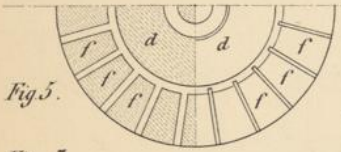


Fig. 5.

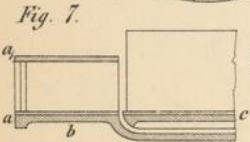


Fig. 7.

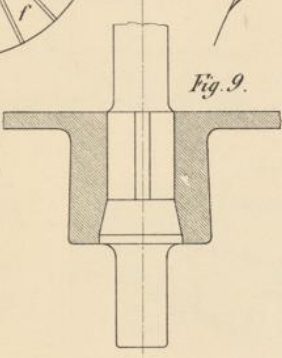


Fig. 9.

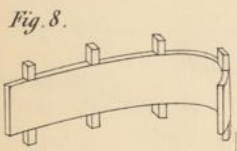


Fig. 8.

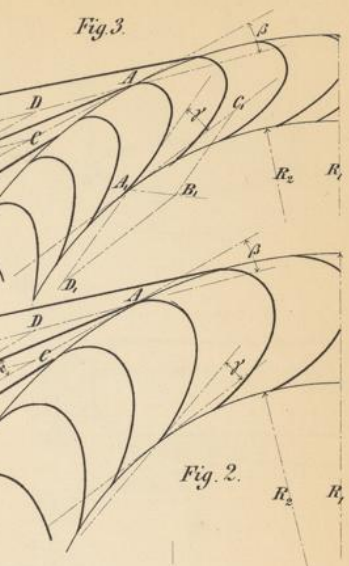


Fig. 3.

Fig. 2.

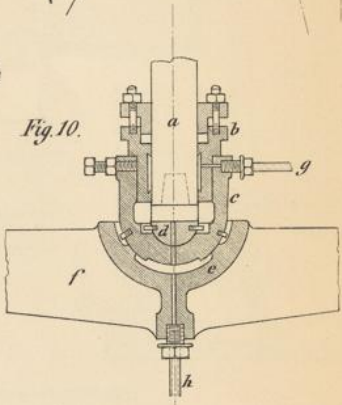


Fig. 10.

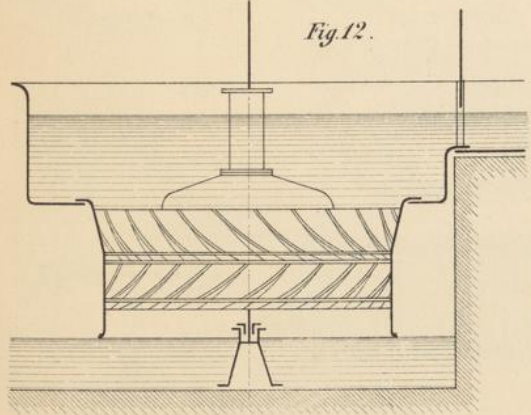


Fig. 12.

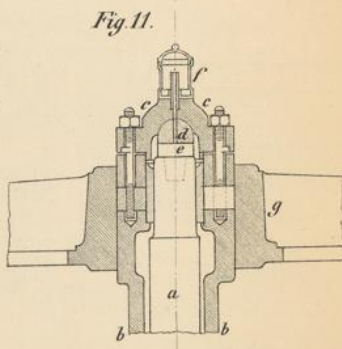
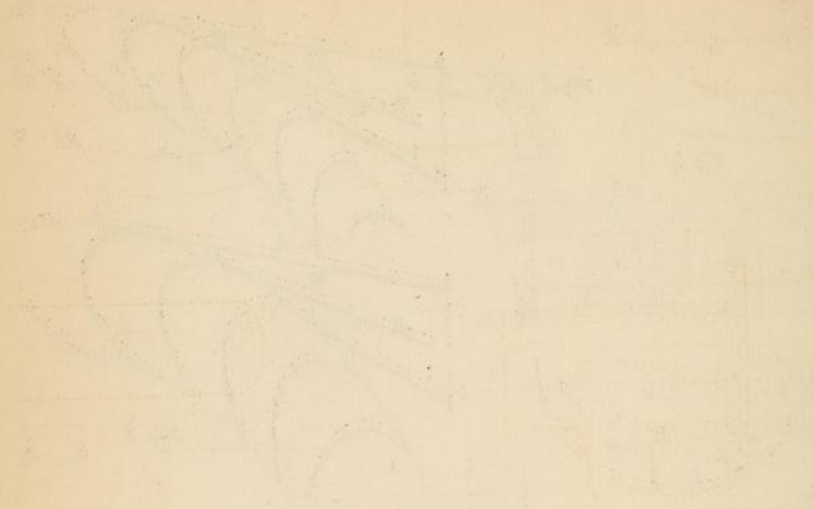
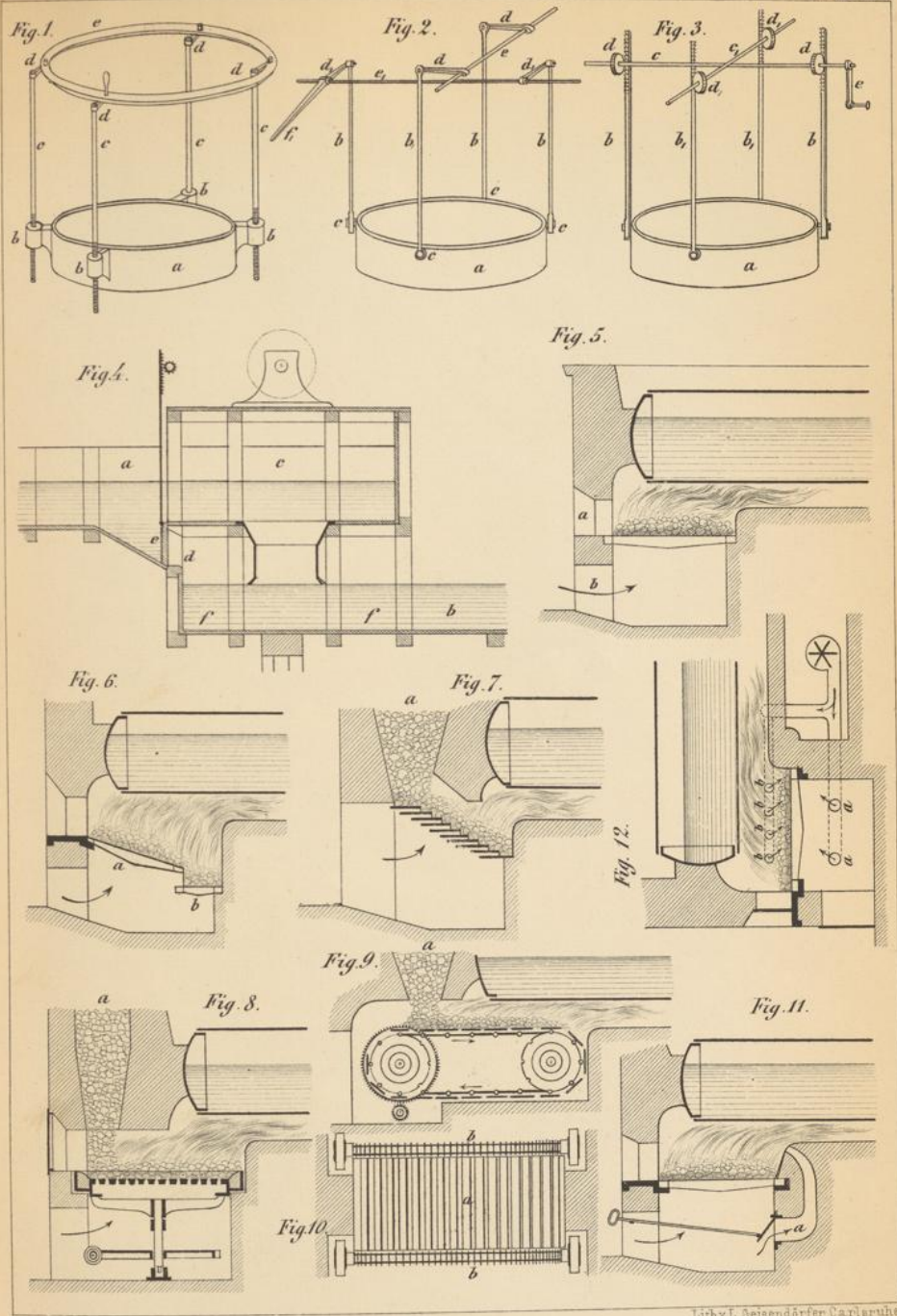


Fig. 11.

142. v. L. v. d. B. v. d. B. v. d. B. v. d. B.

1871
1872





Lith. v. L. Geisendörfer, Carlruhe

Fig. 1.

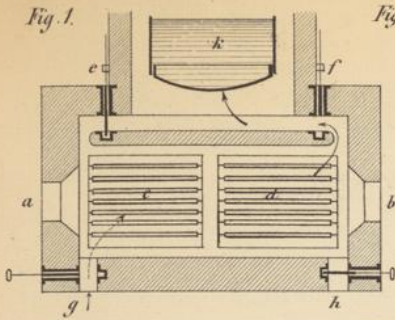


Fig. 2.

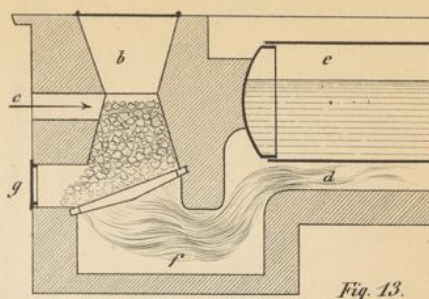


Fig. 3.

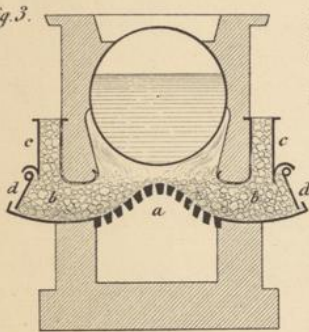


Fig. 4.

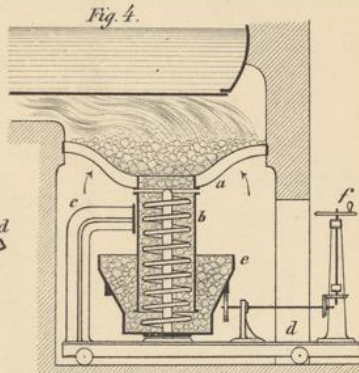


Fig. 13.



Fig. 5.

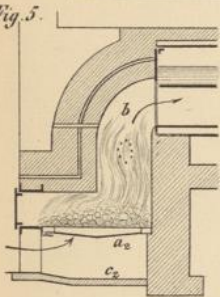


Fig. 6.



Fig. 8.

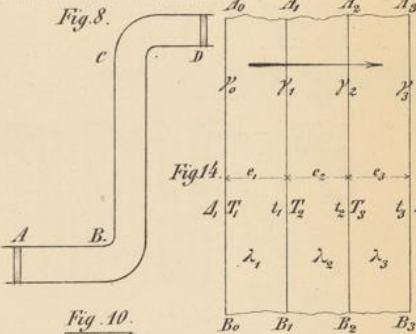


Fig. 14.

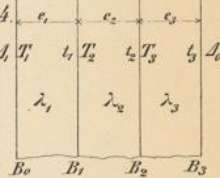


Fig. 7.

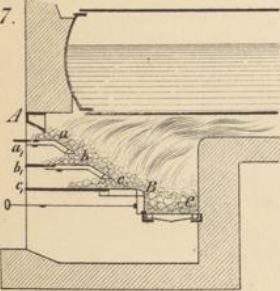


Fig. 9.

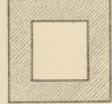


Fig. 10.

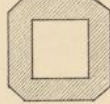


Fig. 11.



Fig. 12.

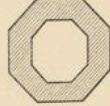
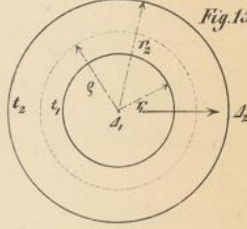
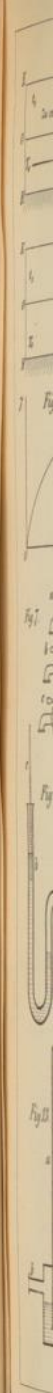
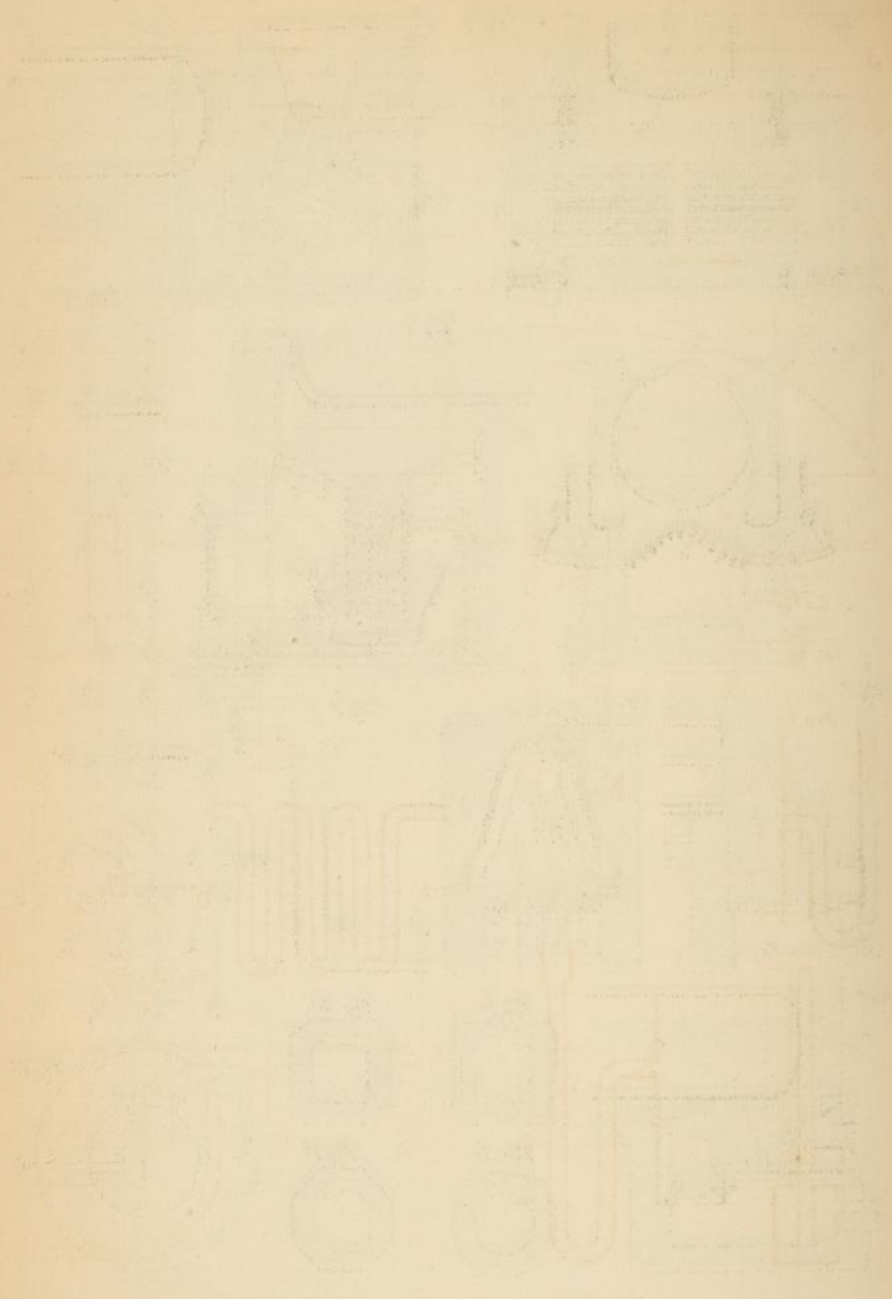
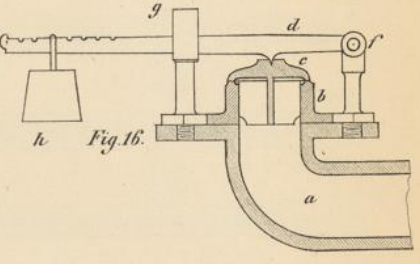
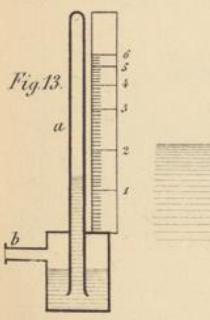
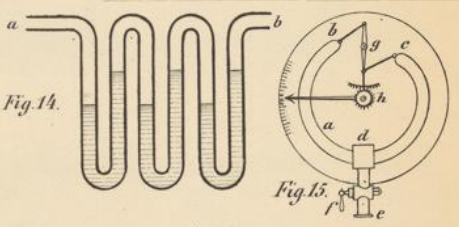
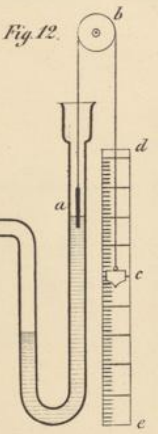
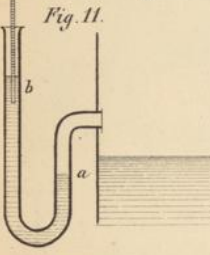
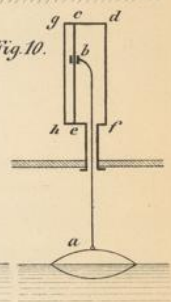
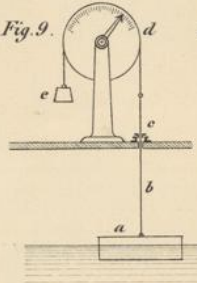
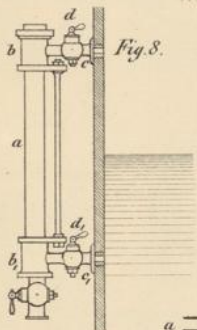
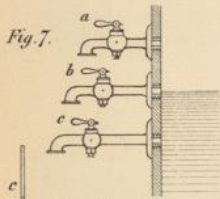
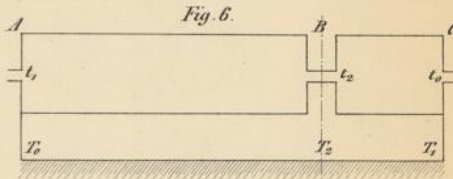
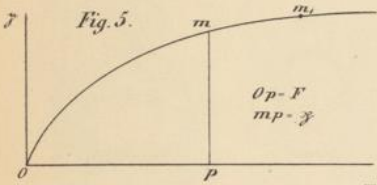
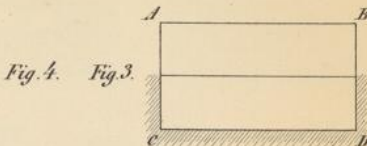
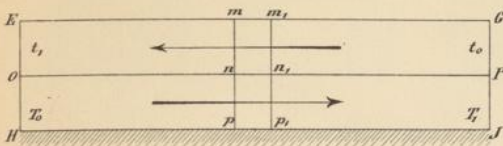
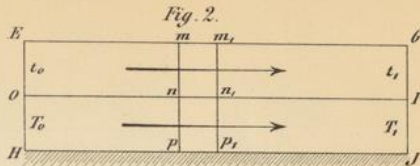
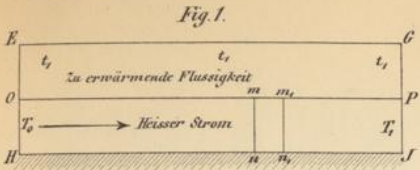


Fig. 15.







Lith. L. Geisendörfer, Carlsruhe.

Fig. 1.

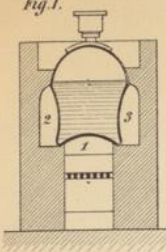


Fig. 2.

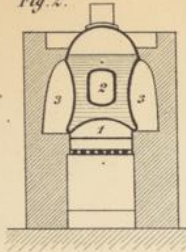


Fig. 3.

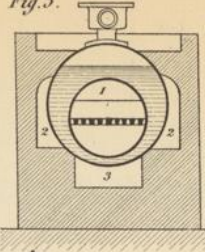


Fig. 4.

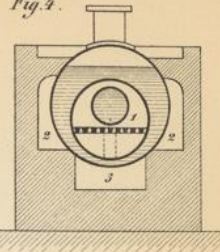


Fig. 5.

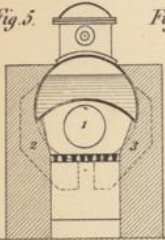


Fig. 6.

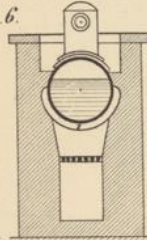


Fig. 7.

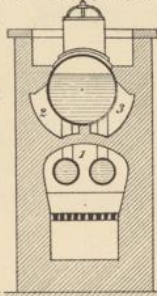


Fig. 8.

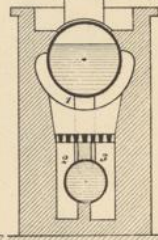


Fig. 9.

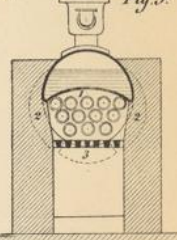


Fig. 10.

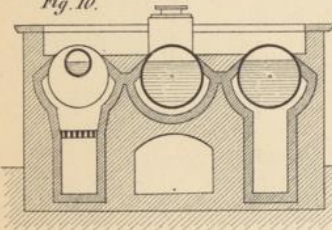


Fig. 11.

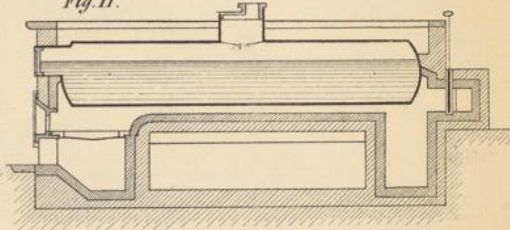


Fig. 12.

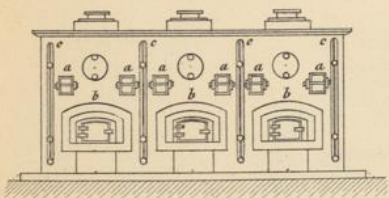


Fig. 13.

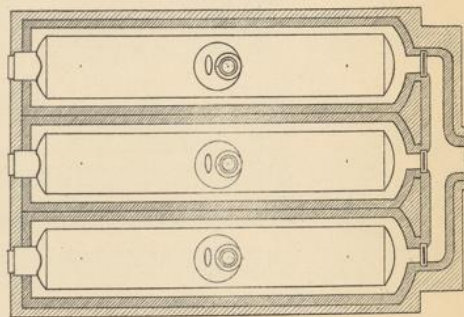


Fig. 1.

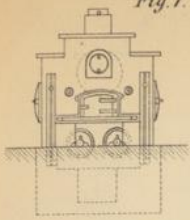


Fig. 2.

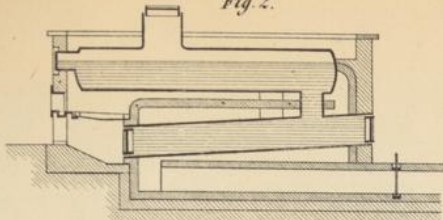


Fig. 3.

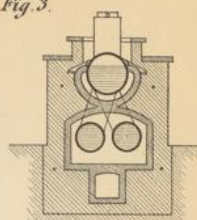


Fig. 4.

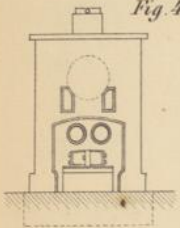


Fig. 5.

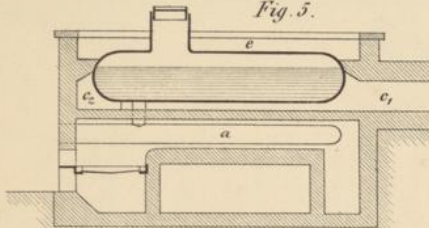


Fig. 6.

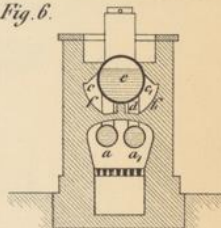


Fig. 8.

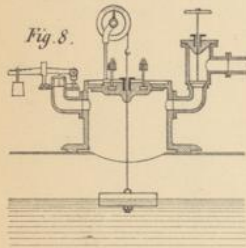


Fig. 7.

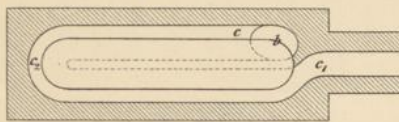


Fig. 9.

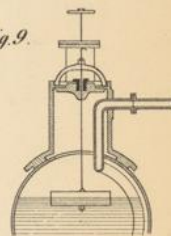


Fig. 10.

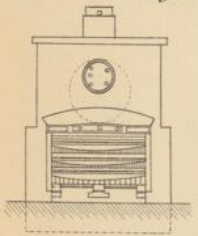


Fig. 11.

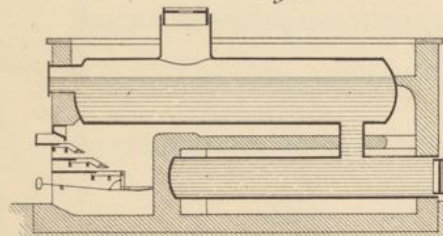


Fig. 12.

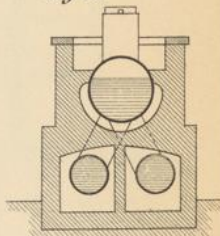


Fig. 13.

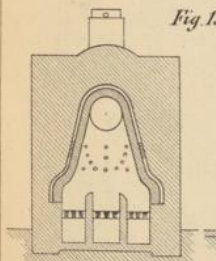


Fig. 14.

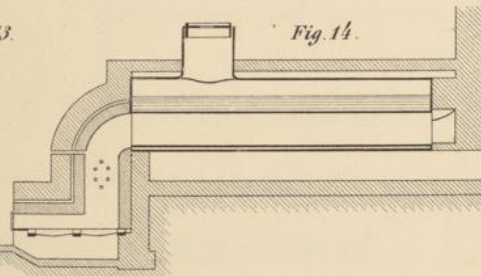
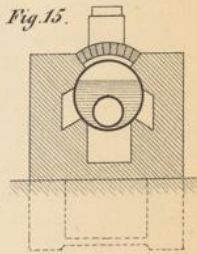
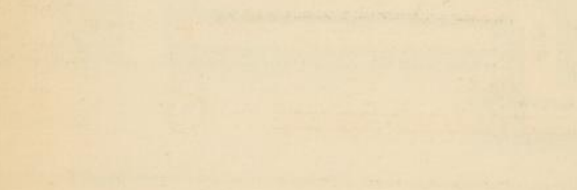
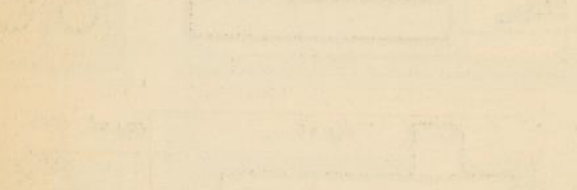


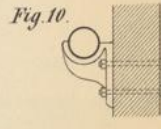
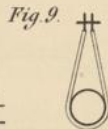
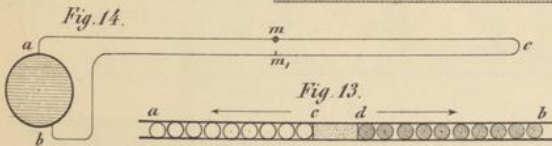
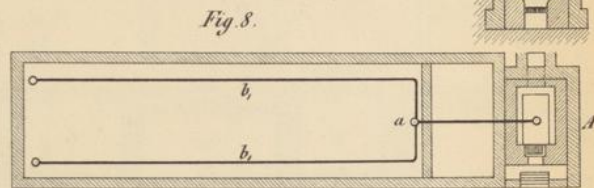
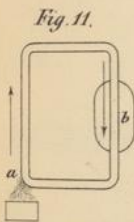
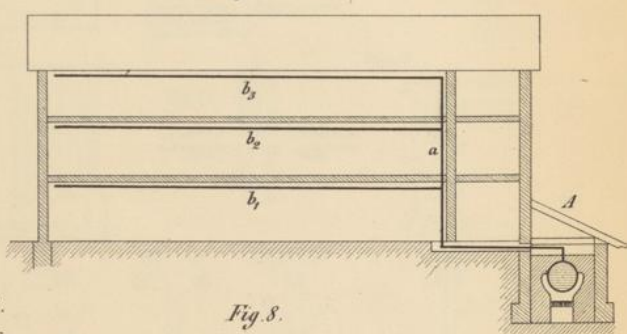
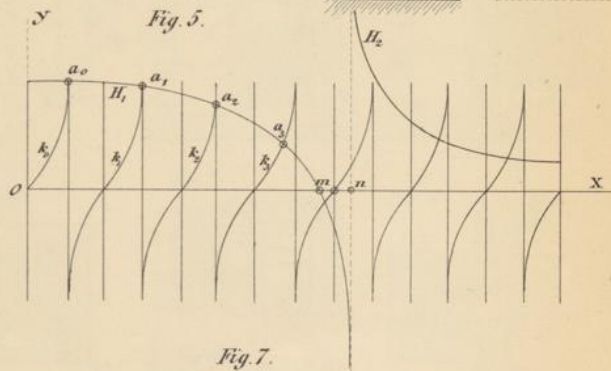
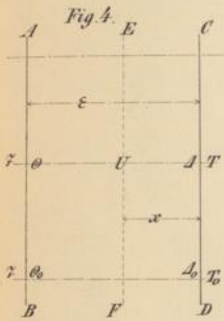
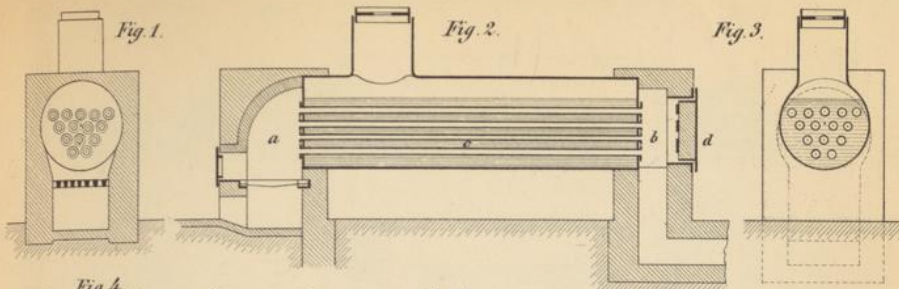
Fig. 15.

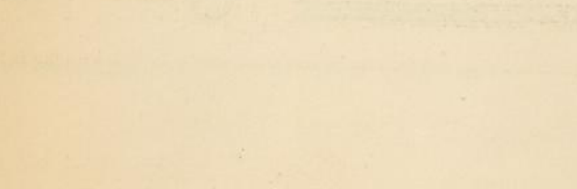
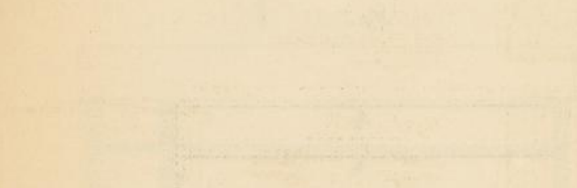
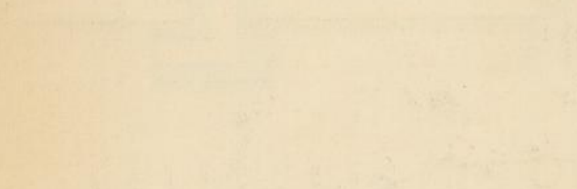


Lith. v. L. Geisenhöfer, Carlsruhe

Handwritten text at the top of the page, possibly a title or page number, which is very faint and difficult to read.







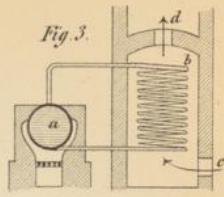
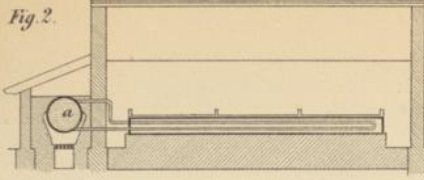
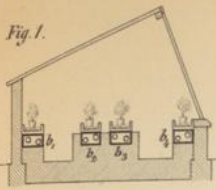


Fig. 4.

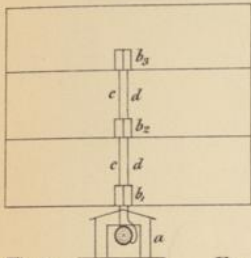


Fig. 5.

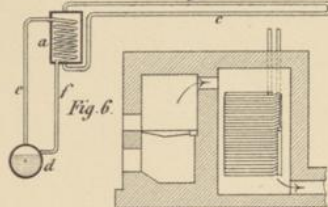


Fig. 8.

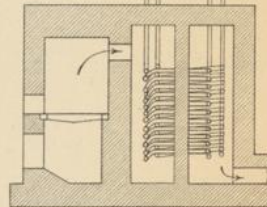


Fig. 6.

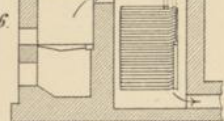


Fig. 11.

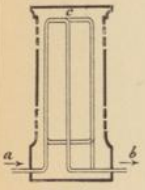


Fig. 12.

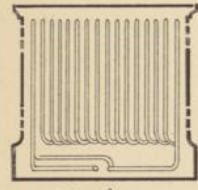


Fig. 7.

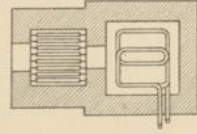


Fig. 9.

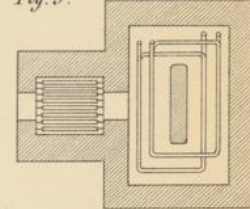


Fig. 10.

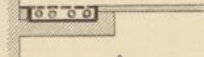


Fig. 13.

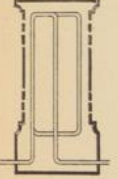


Fig. 14.

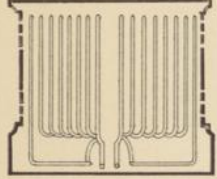


Fig. 16.

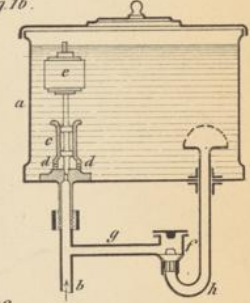


Fig. 15.

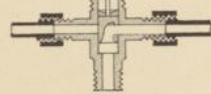


Fig. 20.



Fig. 21.



Fig. 17.

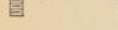


Fig. 18.

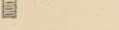


Fig. 19.

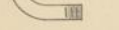
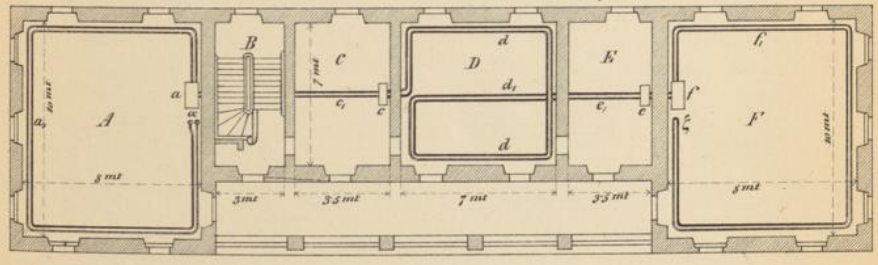
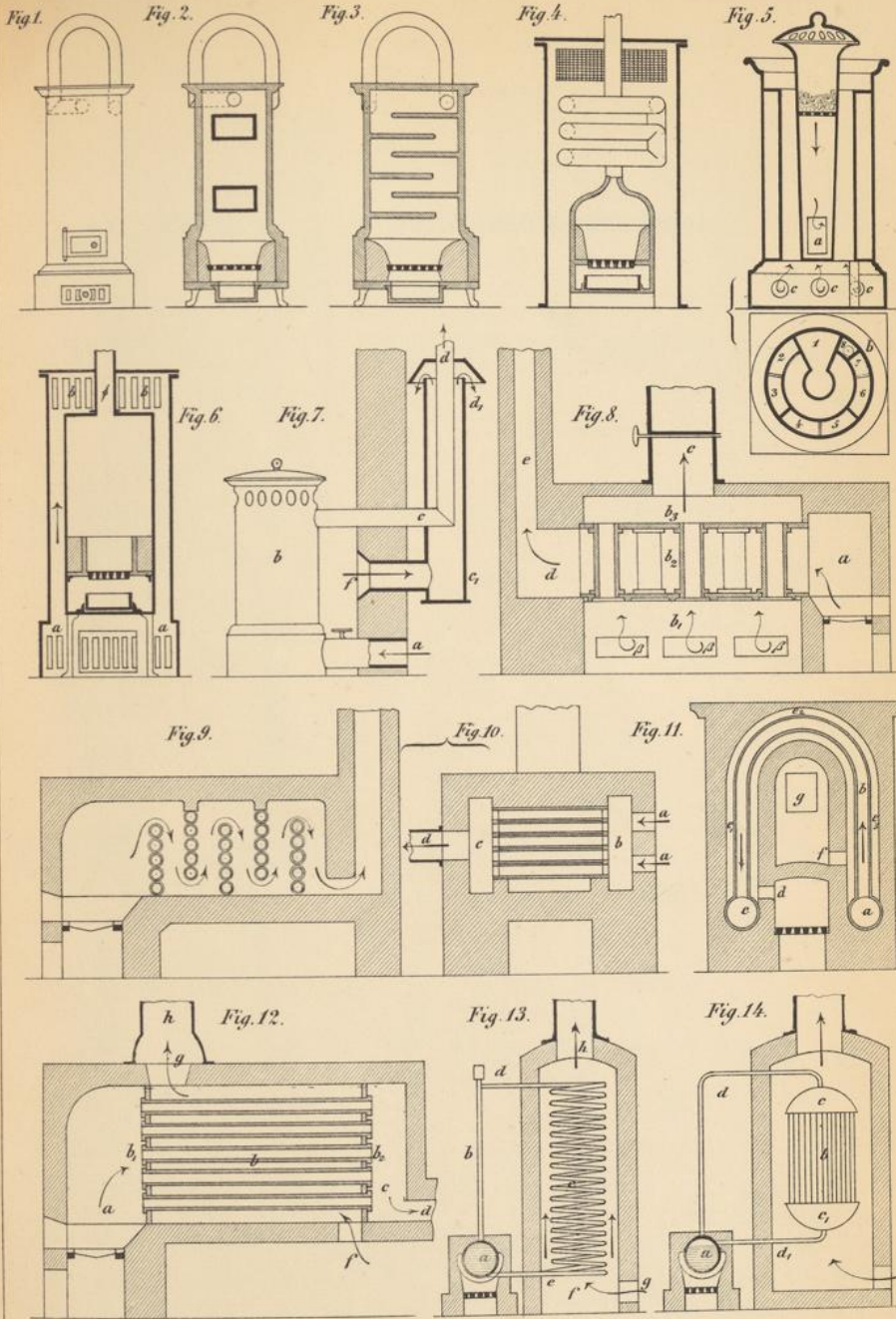


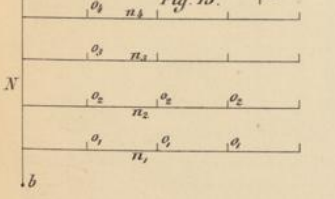
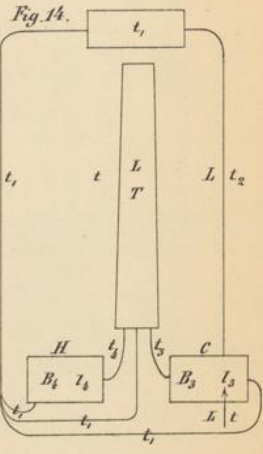
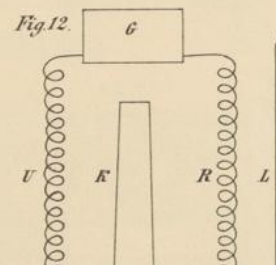
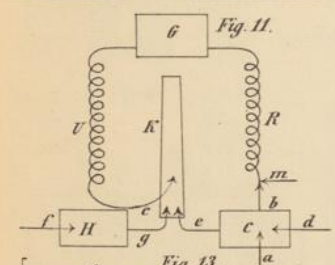
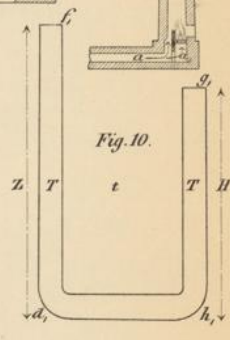
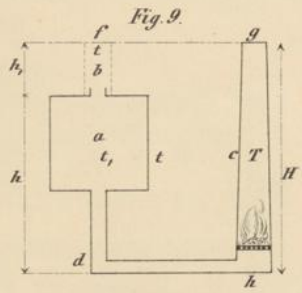
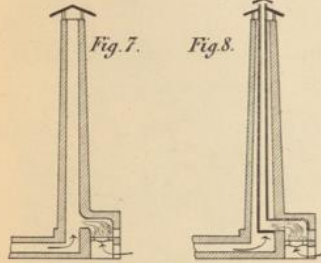
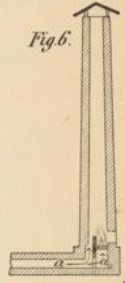
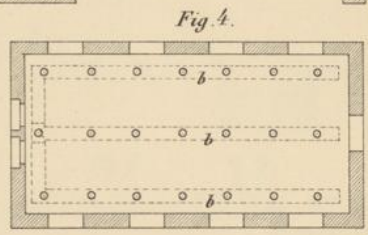
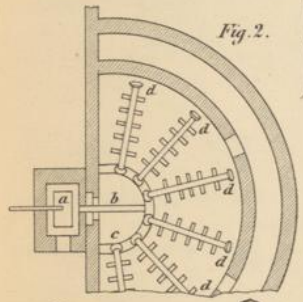
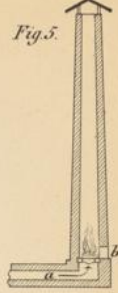
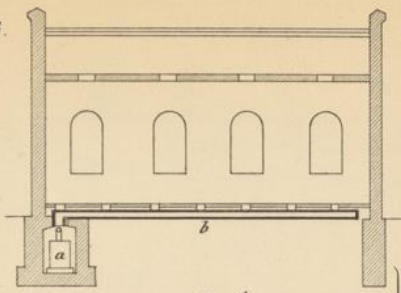
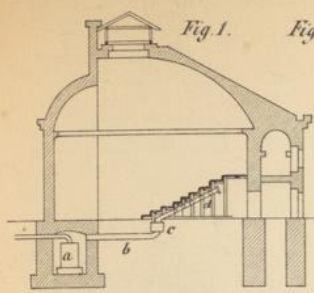
Fig. 22.



Lith. v. L. Geisendörfer, Carlsruhe



Lith. L. Weisenböcker, Carlshütte



Lith. v. L. Geisendorfer, Carlsruhe

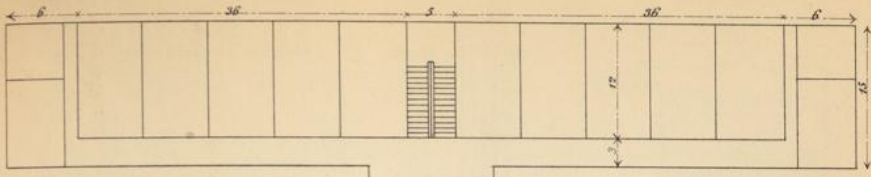


Fig. 1.

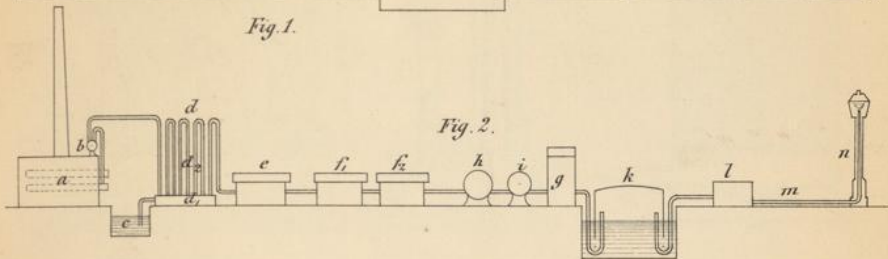


Fig. 2.

Fig. 3.

Fig. 4.

Fig. 5.

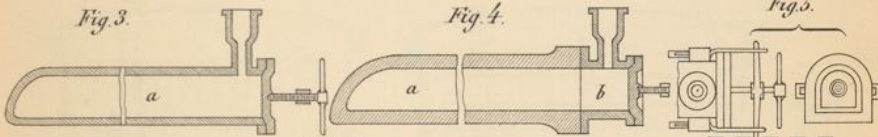


Fig. 6.

Fig. 7.

Fig. 8.

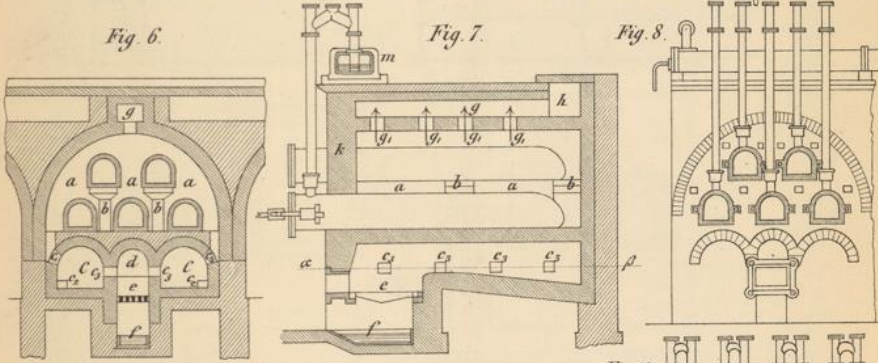


Fig. 10.

Fig. 11.

Fig. 9.

Fig. 13.

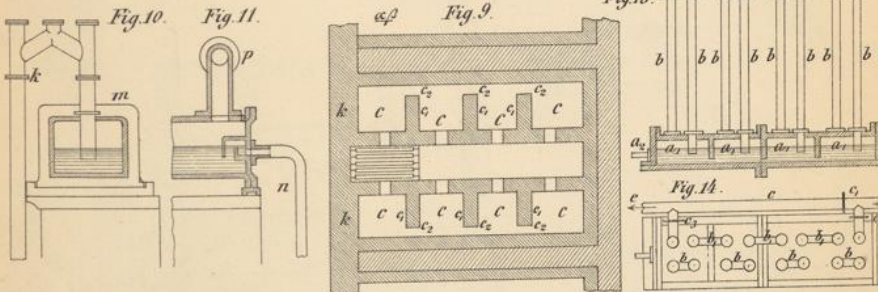
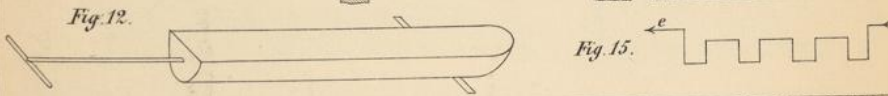


Fig. 12.

Fig. 15.



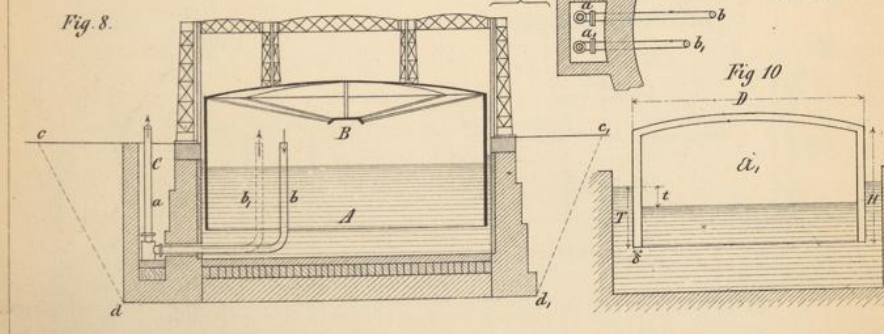
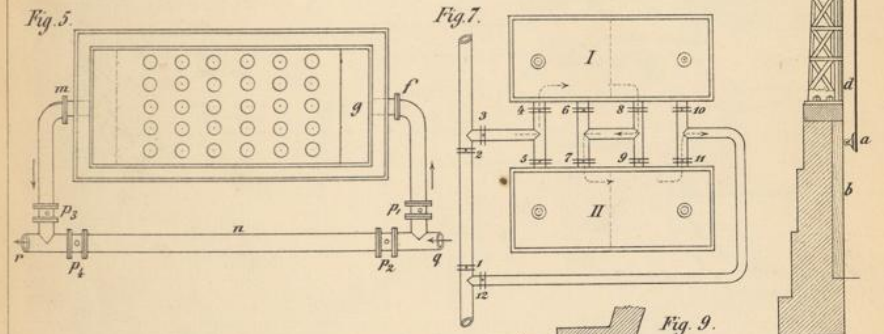
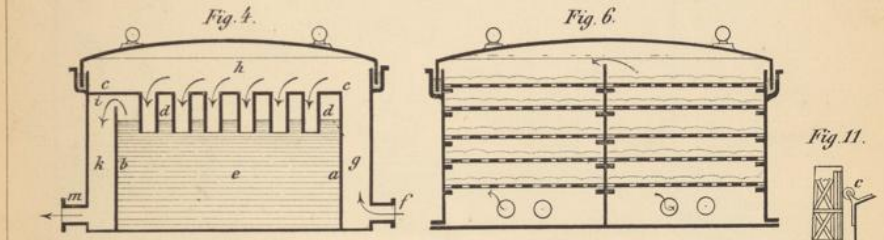
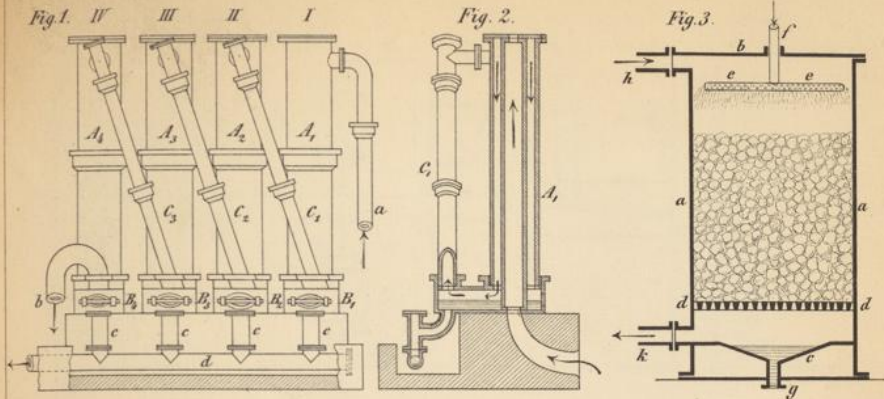


Fig. 1.

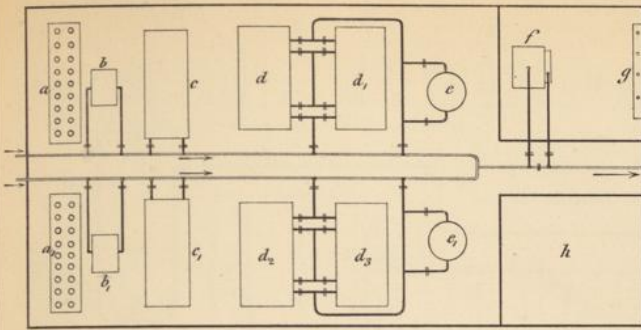


Fig. 2.

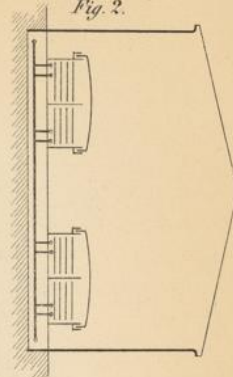


Fig. 3.

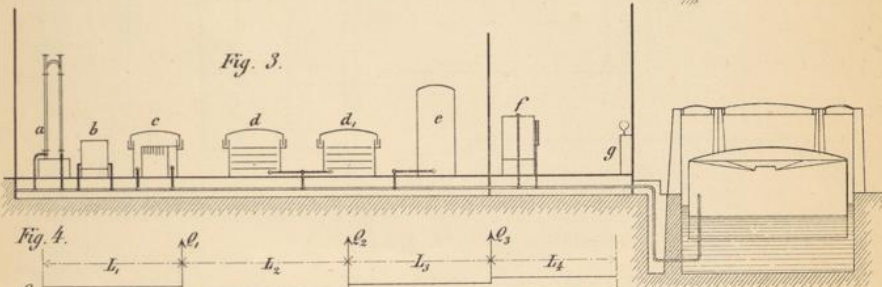


Fig. 4.

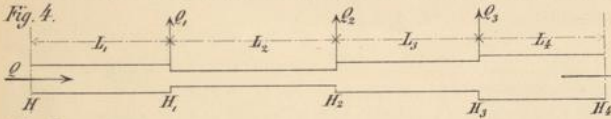


Fig. 5.

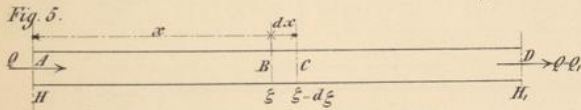


Fig. 6.

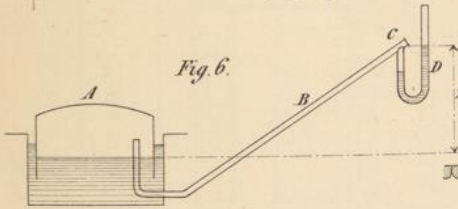


Fig. 9.

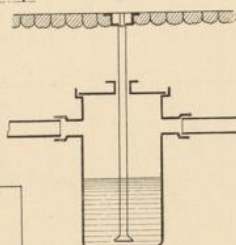


Fig. 8.

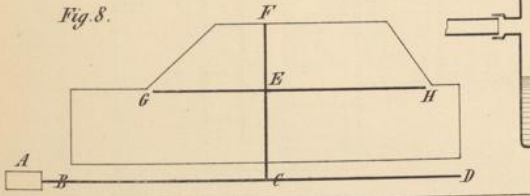


Fig. 7.

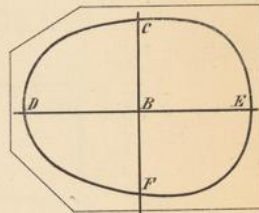
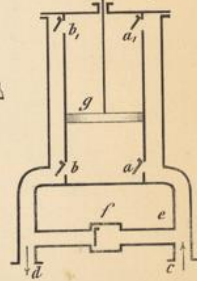


Fig. 10.



Lith. v. L. Gosenörffer, Karlsruhe

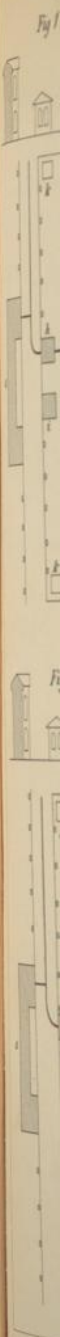
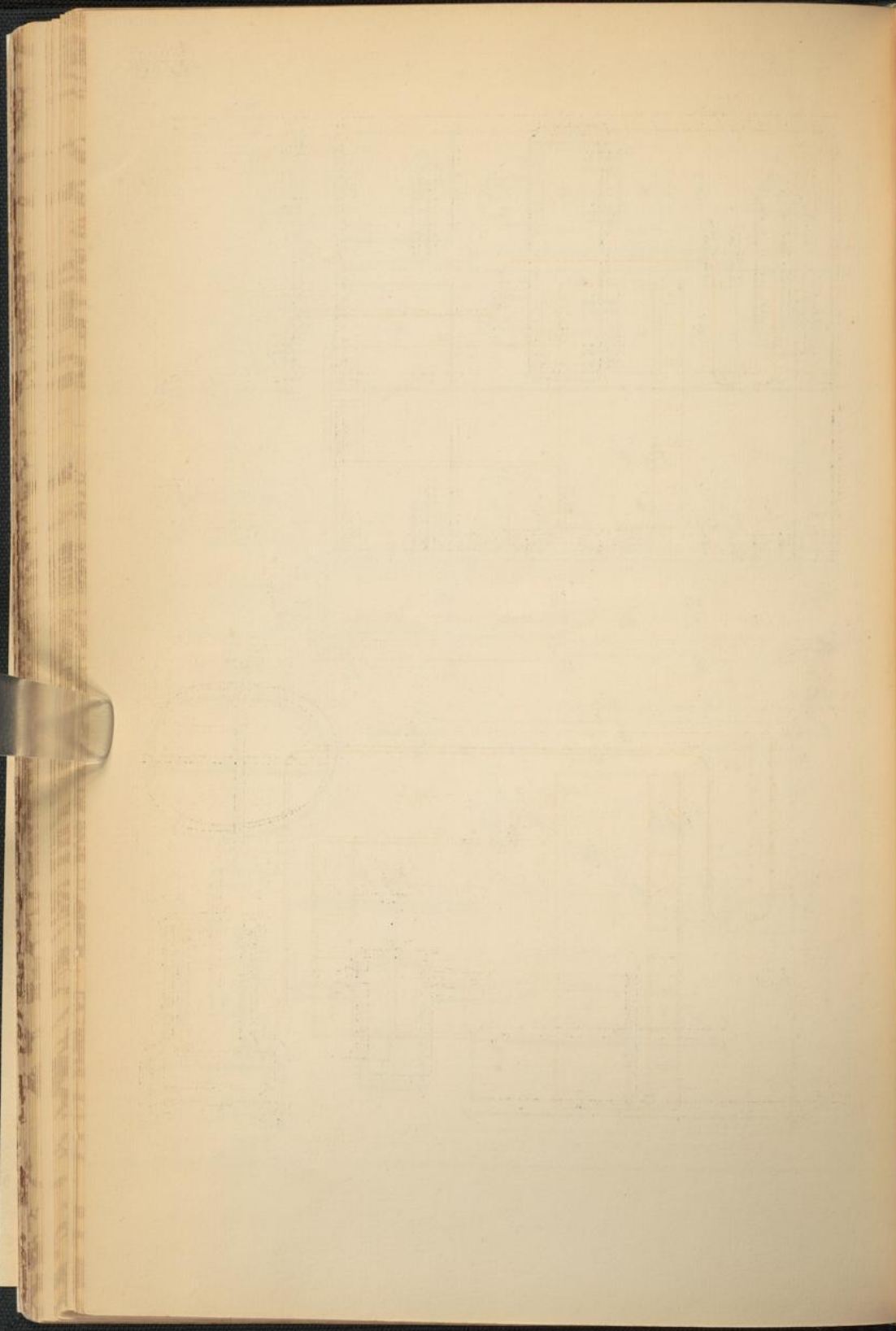


Fig 1.

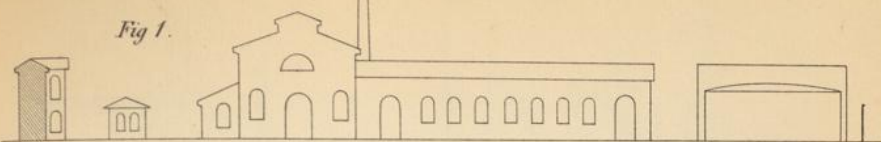


Fig. 2.

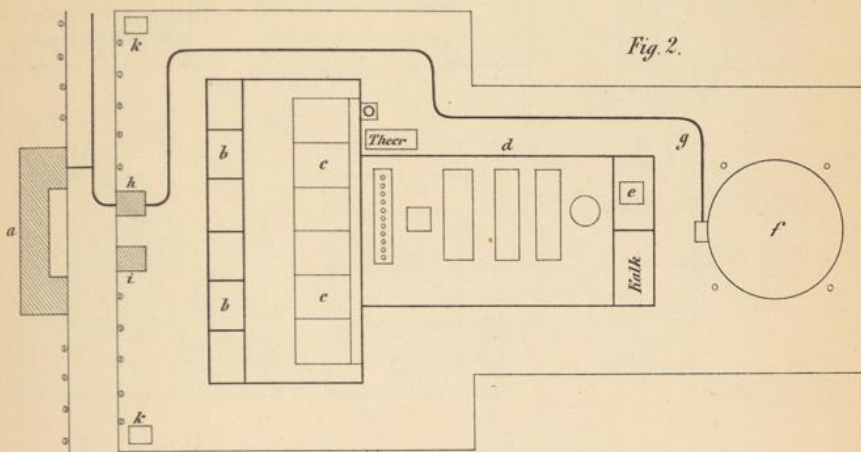


Fig. 3.

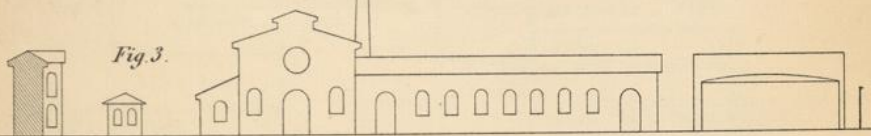
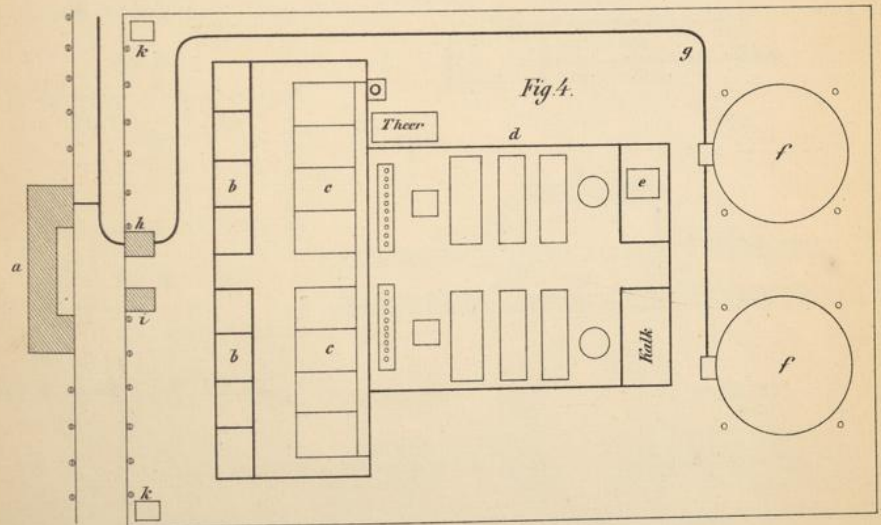
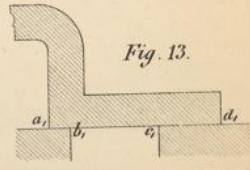
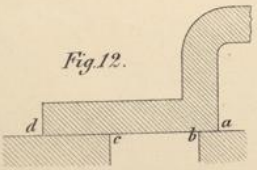
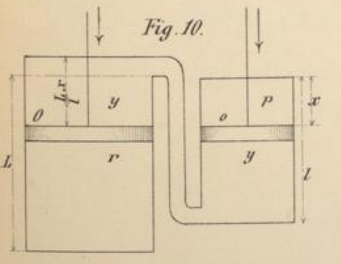
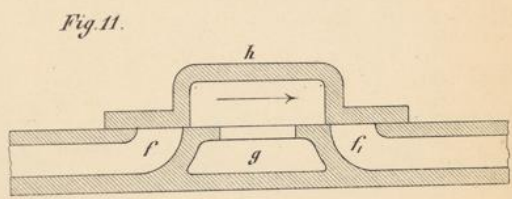
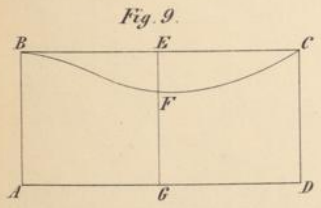
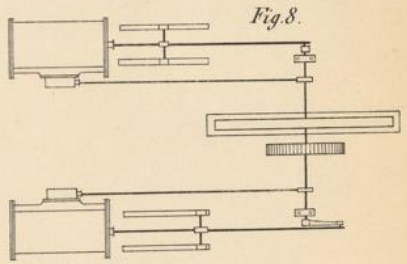
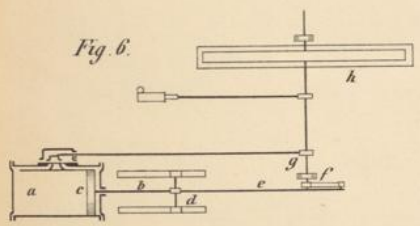
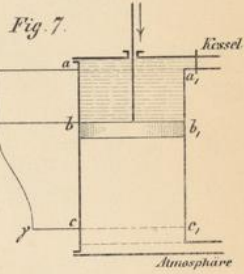
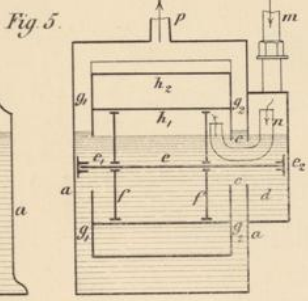
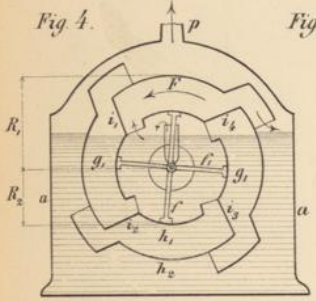
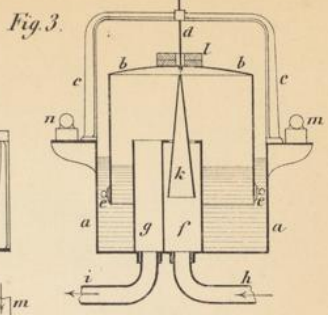
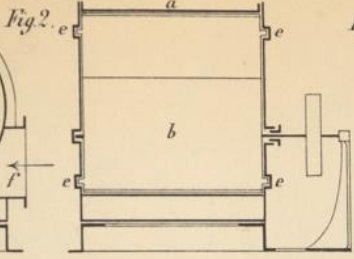
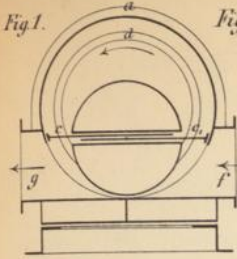


Fig. 4.



Lith. v. L. Geismendörfer, Carlsruhe



Ich. v. L. Geisendörfer, Carlr. d. B.

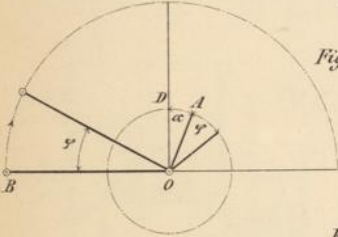
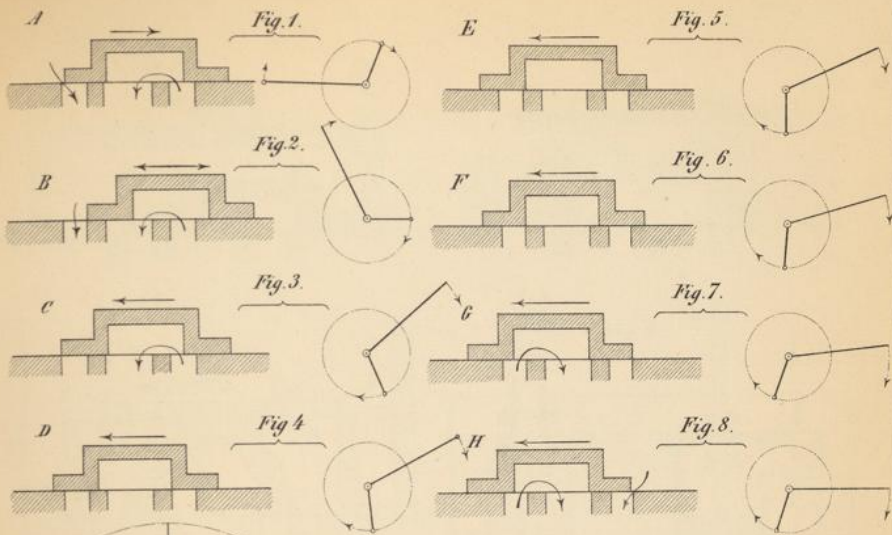


Fig. 9.

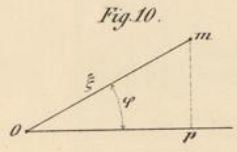


Fig. 10.

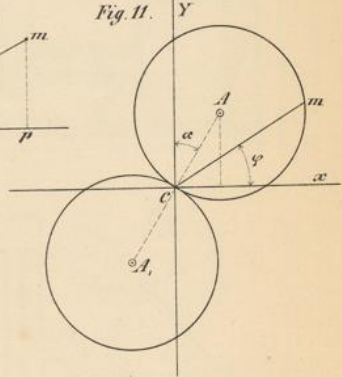


Fig. 11.

Fig. 12.

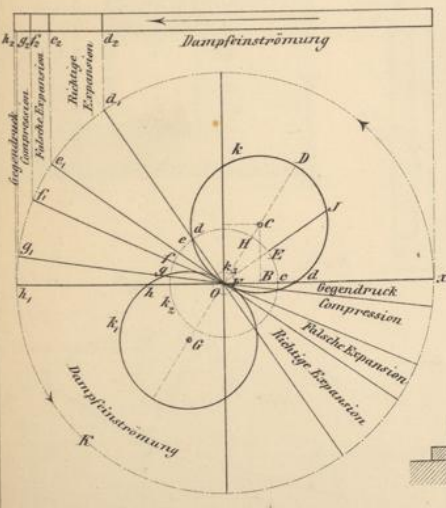


Fig. 13. A.

Fig. 14. B.

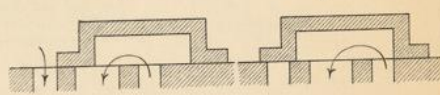
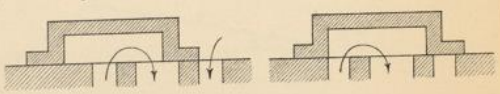
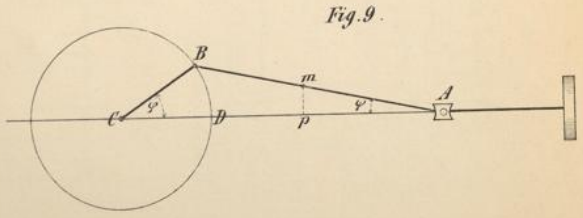
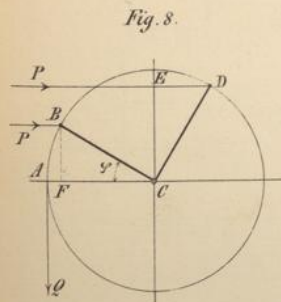
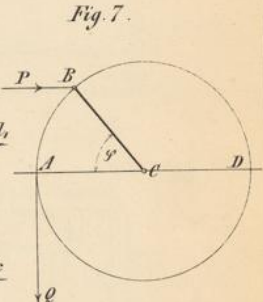
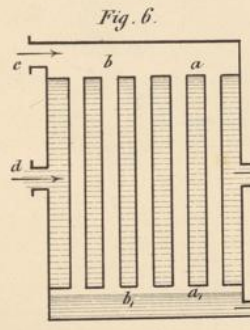
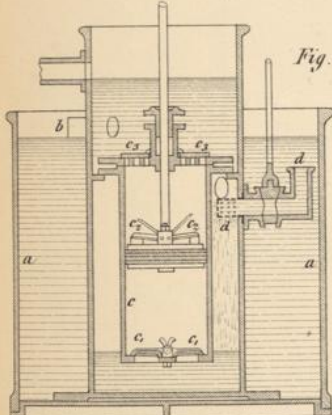
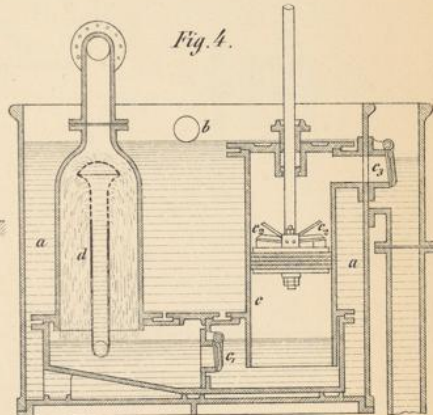
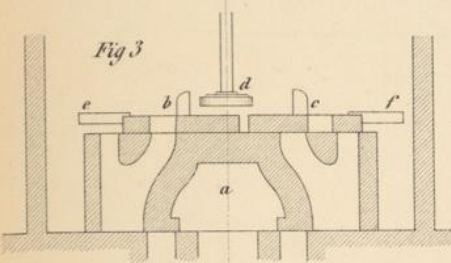
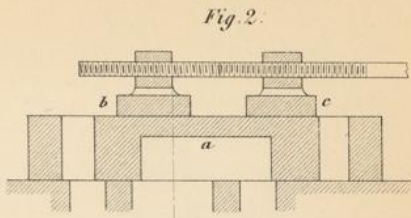
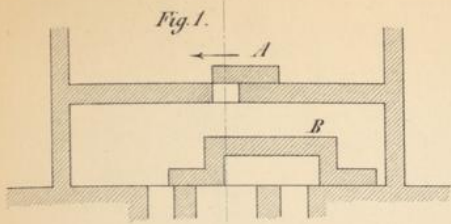


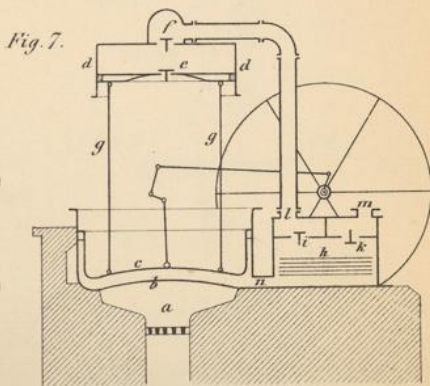
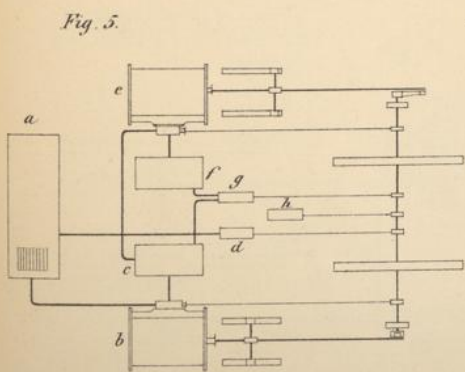
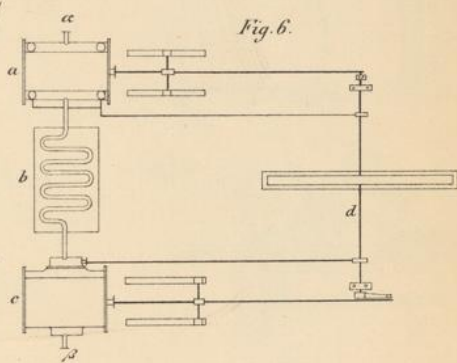
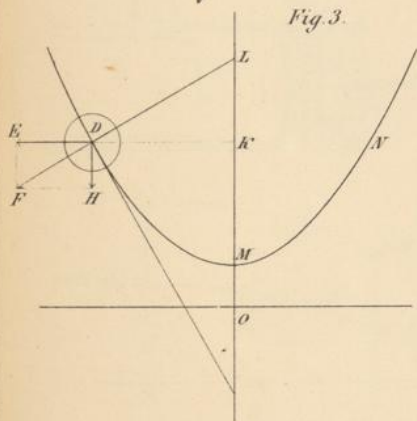
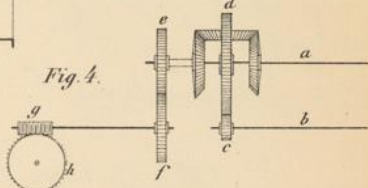
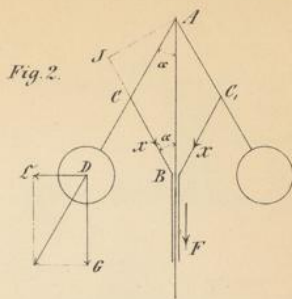
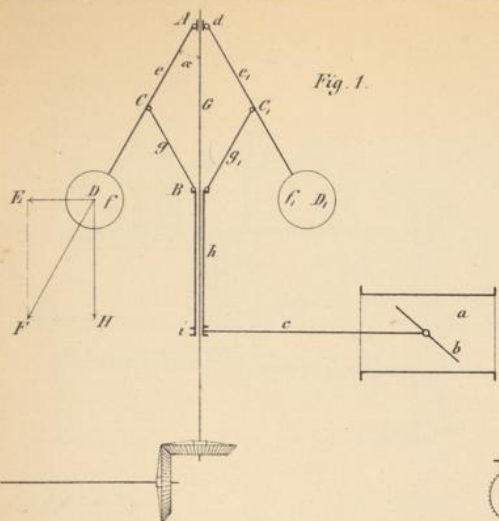
Fig. 15. C.

Fig. 16. D.





lith. v. L. Geisenhöfer, Carlruhe



Lith. v. L. Geisendörfer, Carlsruhe.

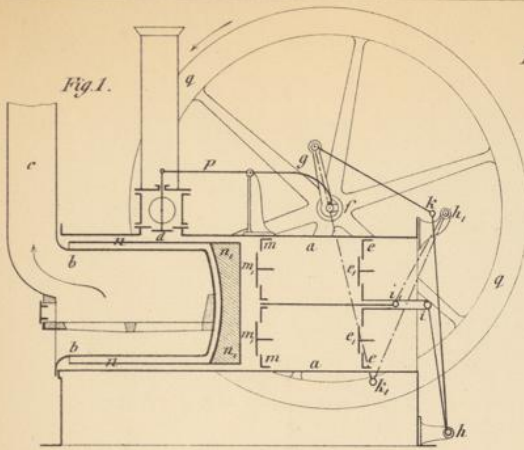


Fig. 2.

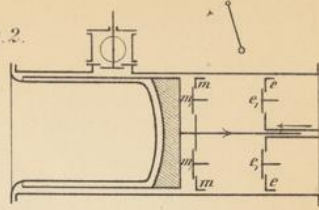


Fig. 3.

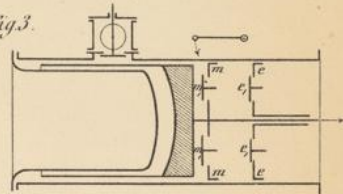


Fig. 4.

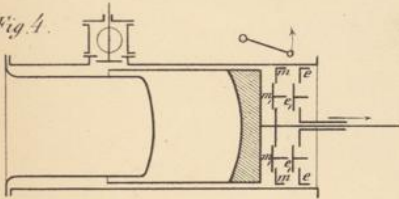


Fig. 5.

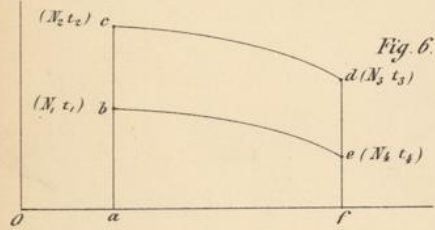
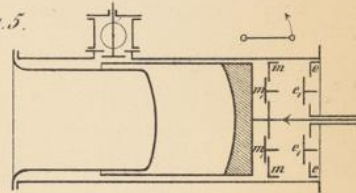


Fig. 6.

Fig. 8.

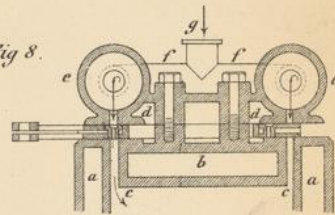


Fig. 9.

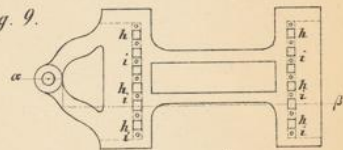


Fig. 10.

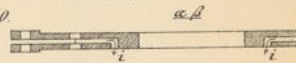
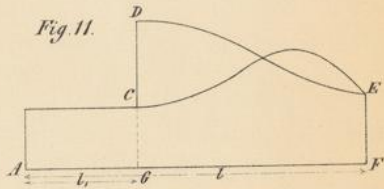
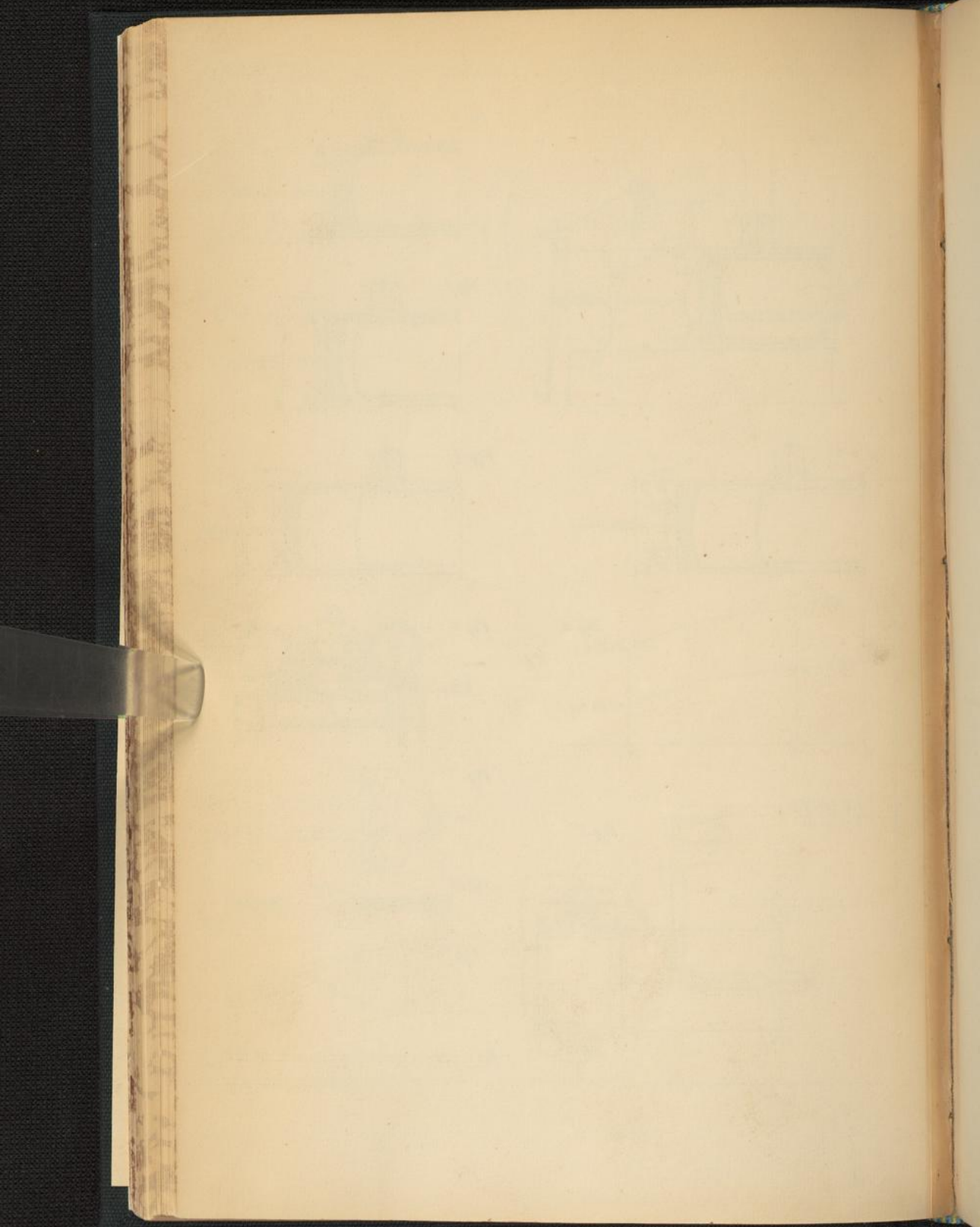
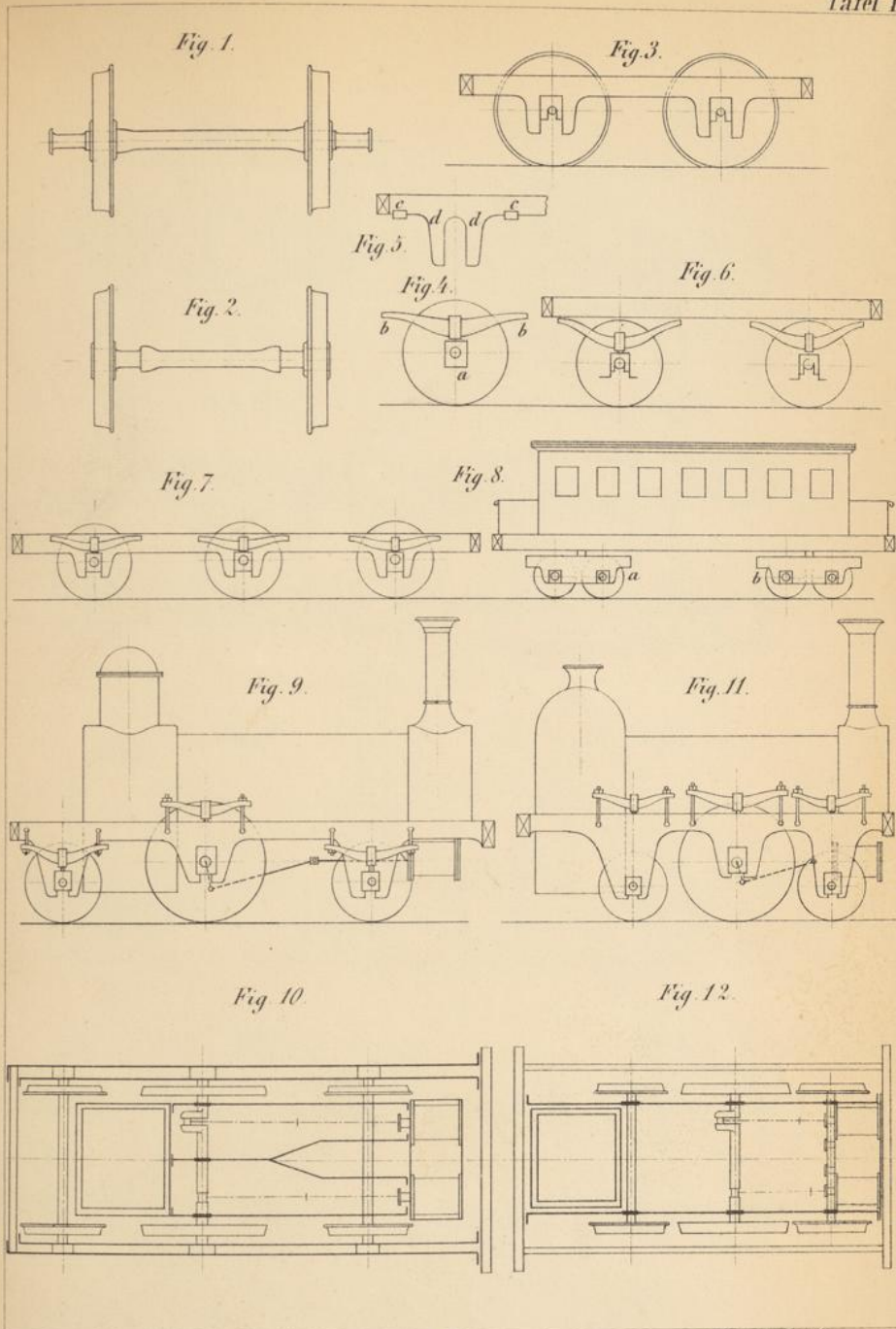


Fig. 11.



Lith. v. L. Weisenböcker, Carlsruhe





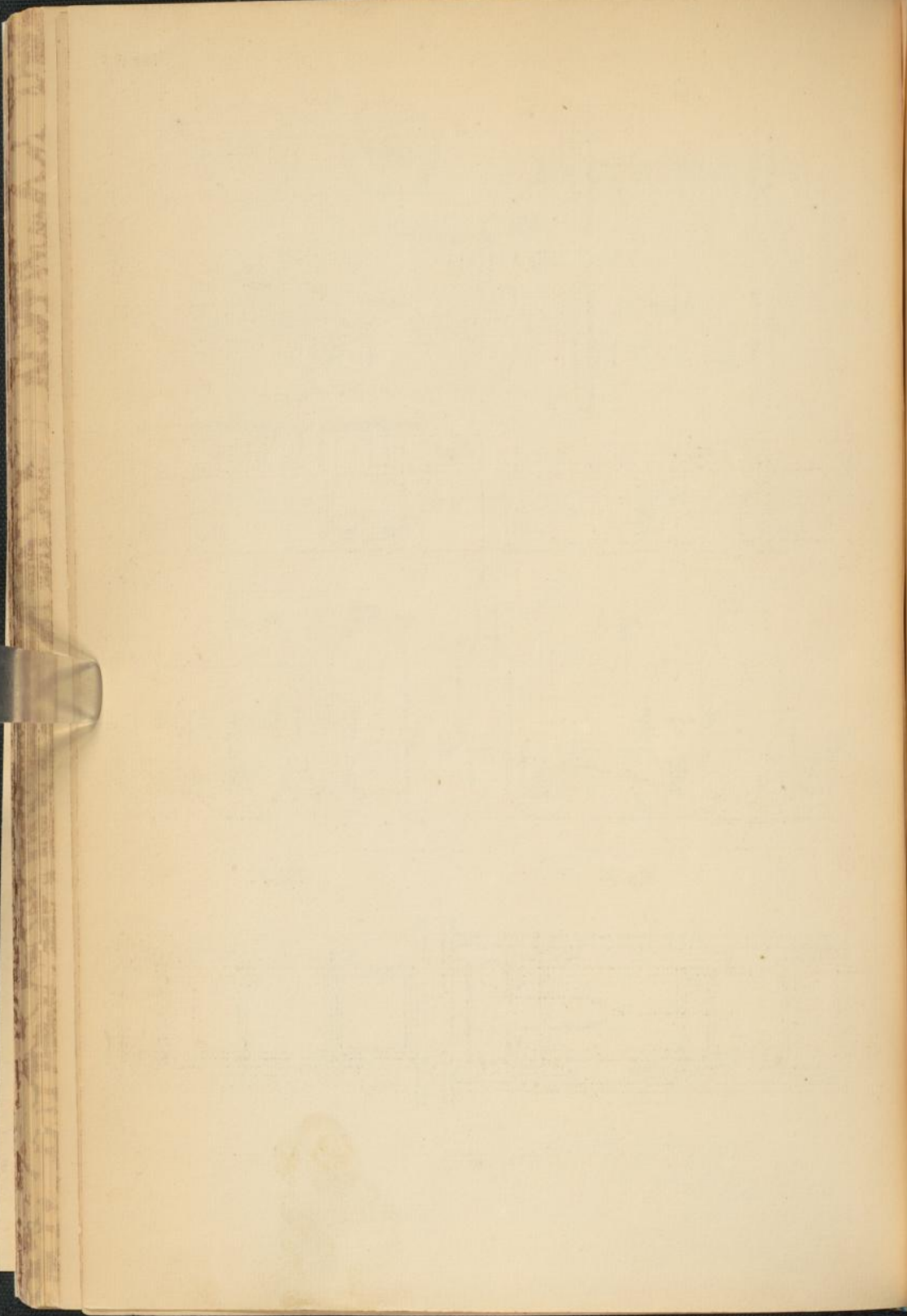


Fig. 1.

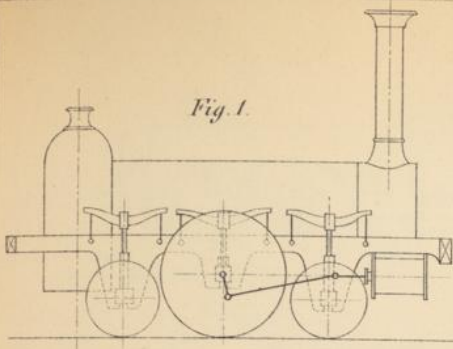


Fig. 3.

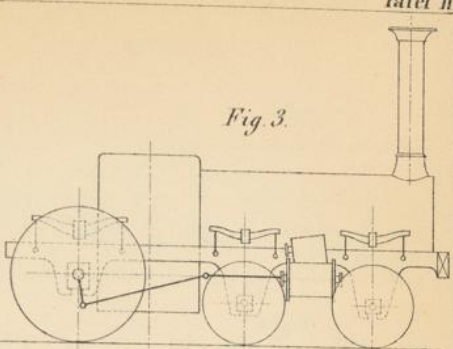


Fig. 2.

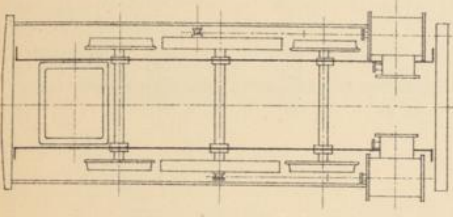


Fig. 4.

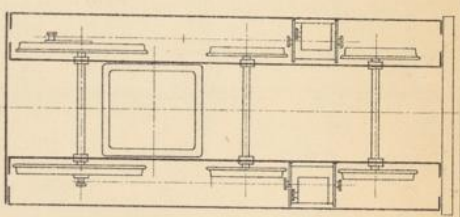


Fig. 5.

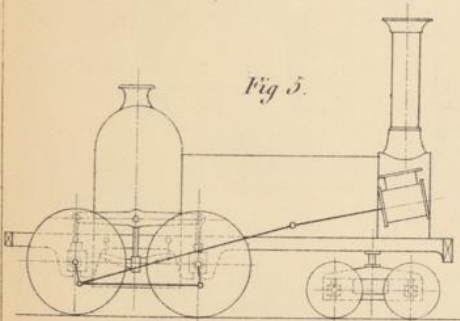


Fig. 7.

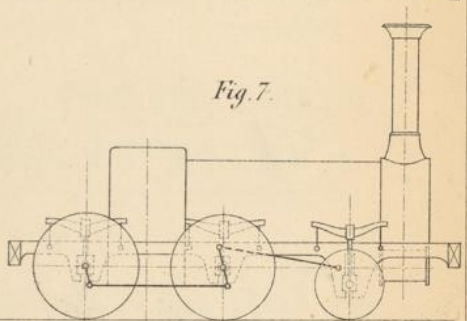


Fig. 6.

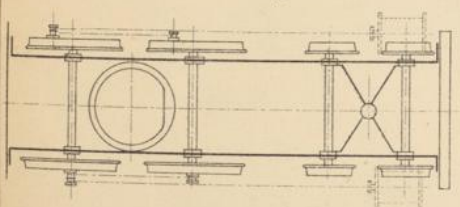
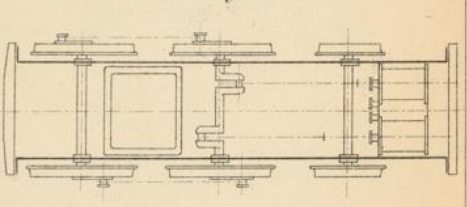
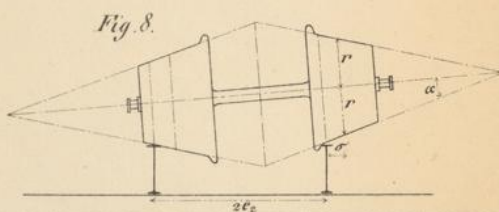
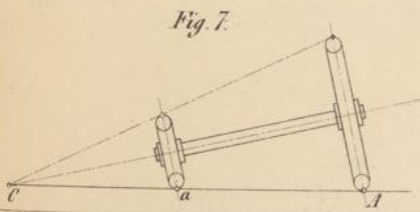
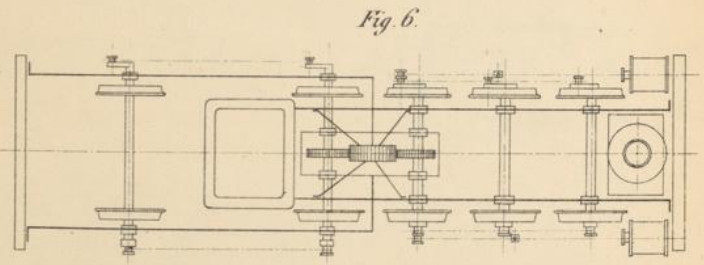
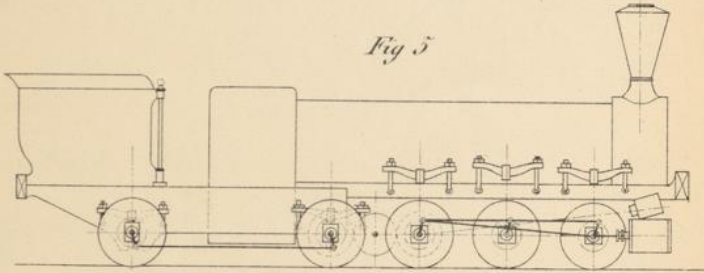
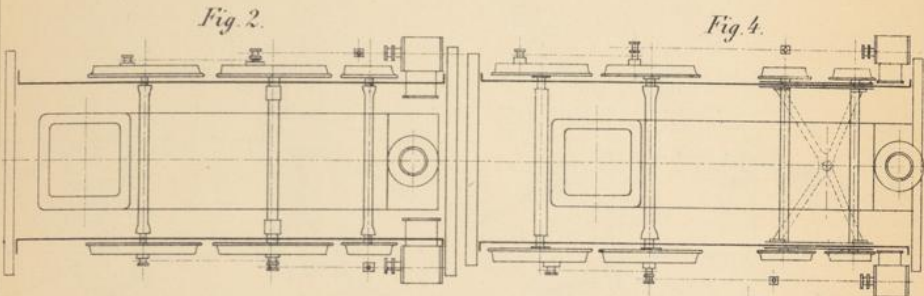
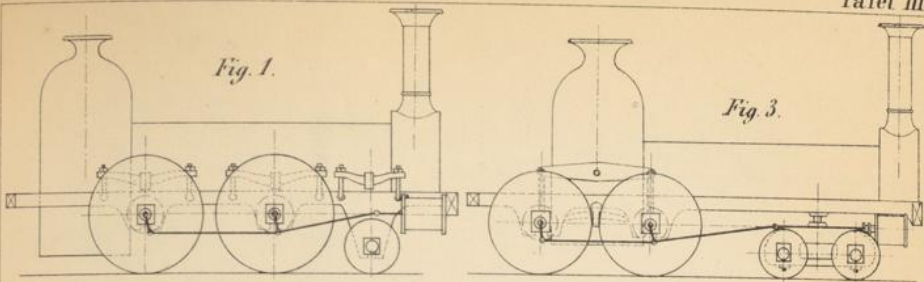


Fig. 8.





III.

lith. L. Geisenhöfer, Carlsruhe

Fig. 1.

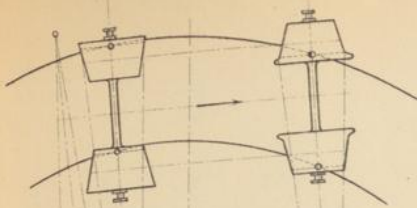


Fig. 4.

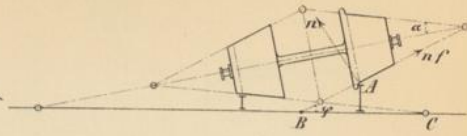


Fig. 2.

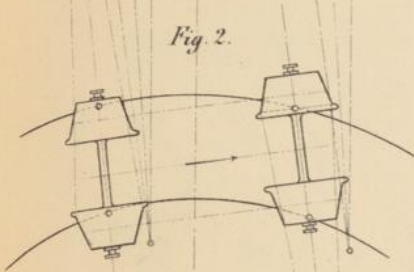


Fig. 5.

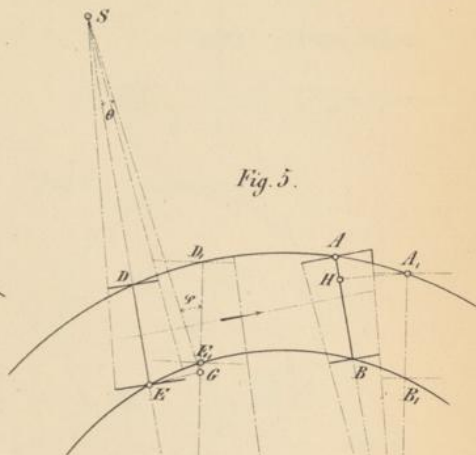


Fig. 3.

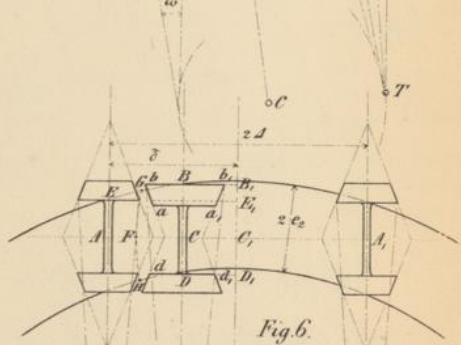
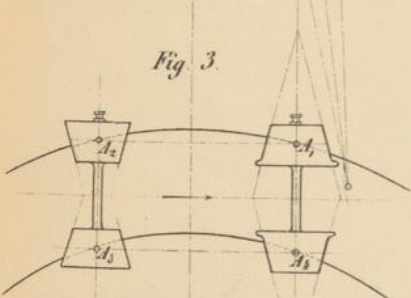
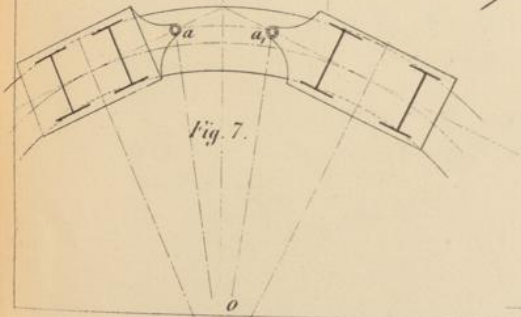
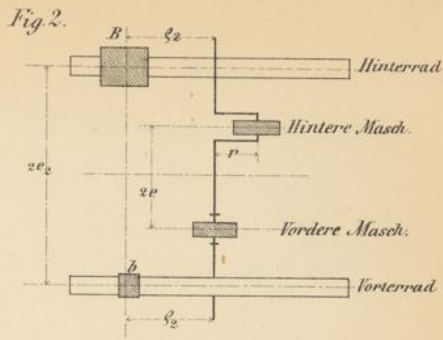
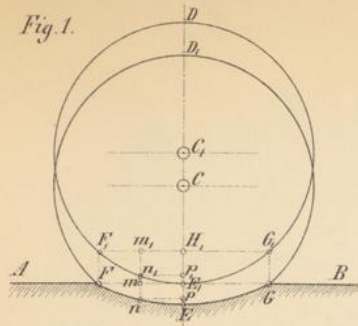


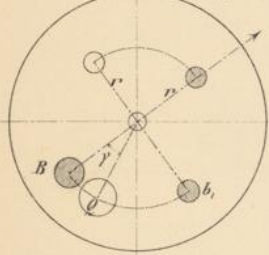
Fig. 6.

Fig. 7.

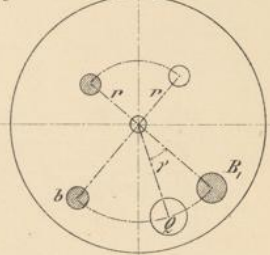




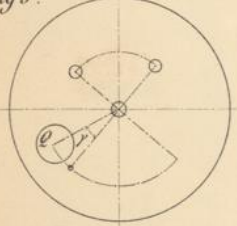
Hinterrad Fig. 3.



Vorderrad Fig. 4.



Hinterrad Fig. 5.



Vorderrad Fig. 6.

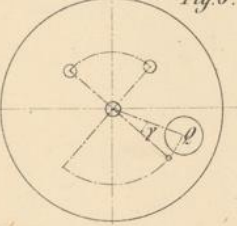
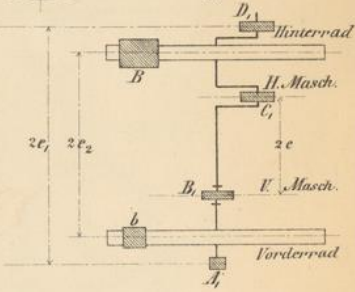
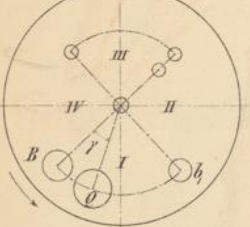


Fig. 7.



Hinterrad Fig. 8.



Vorderrad Fig. 9.

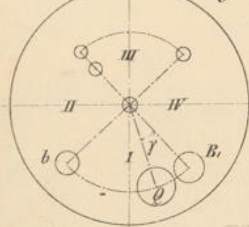


Fig. 10.

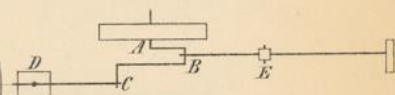
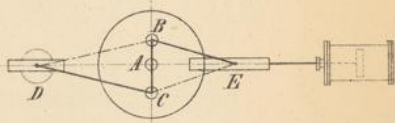
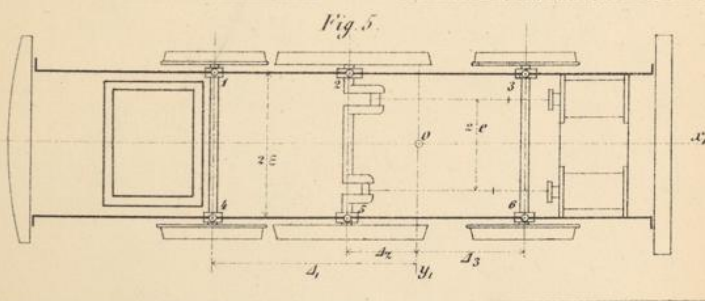
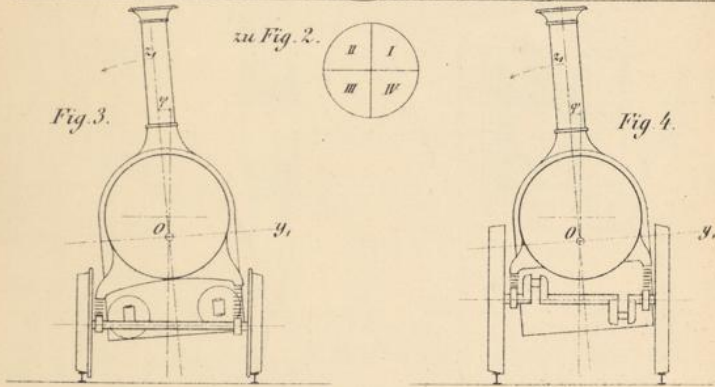
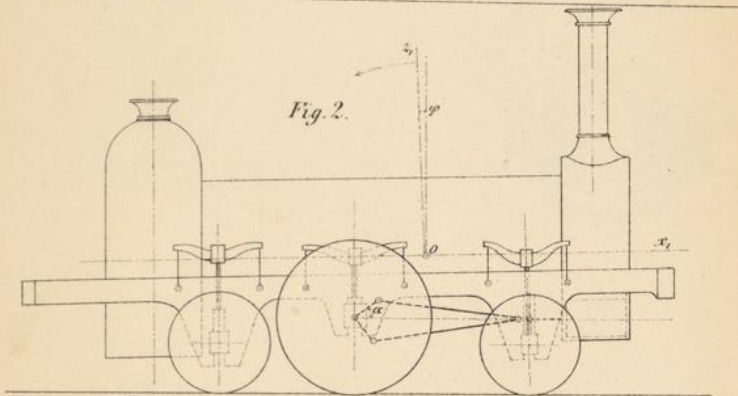
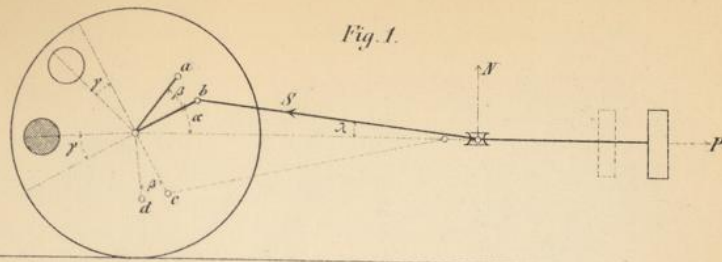


Fig. 11.





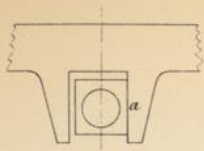


Fig. 1.

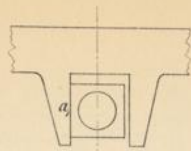


Fig. 2.

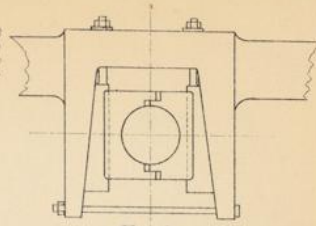


Fig. 3.

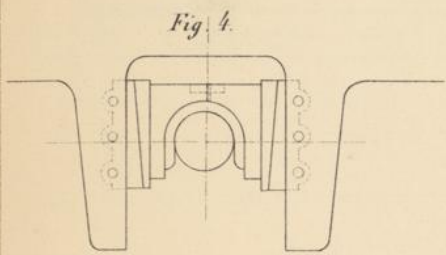


Fig. 4.

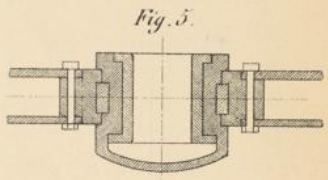


Fig. 5.

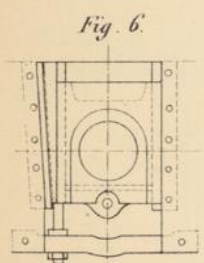


Fig. 6.

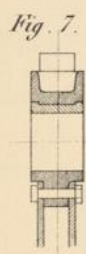


Fig. 7.

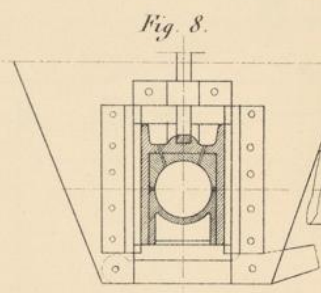


Fig. 8.

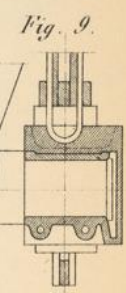


Fig. 9.

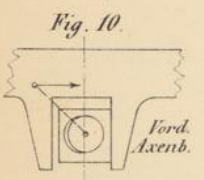


Fig. 10.

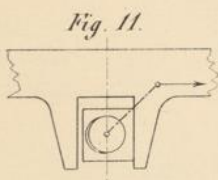


Fig. 11.

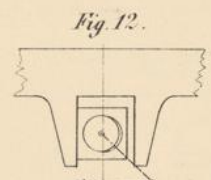


Fig. 12.

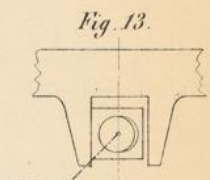


Fig. 13.

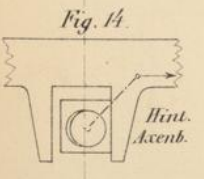


Fig. 14.

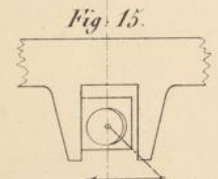


Fig. 15.

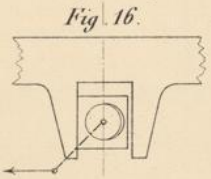


Fig. 16.

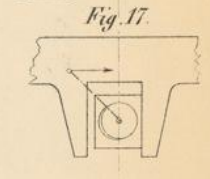
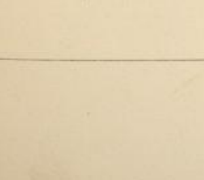
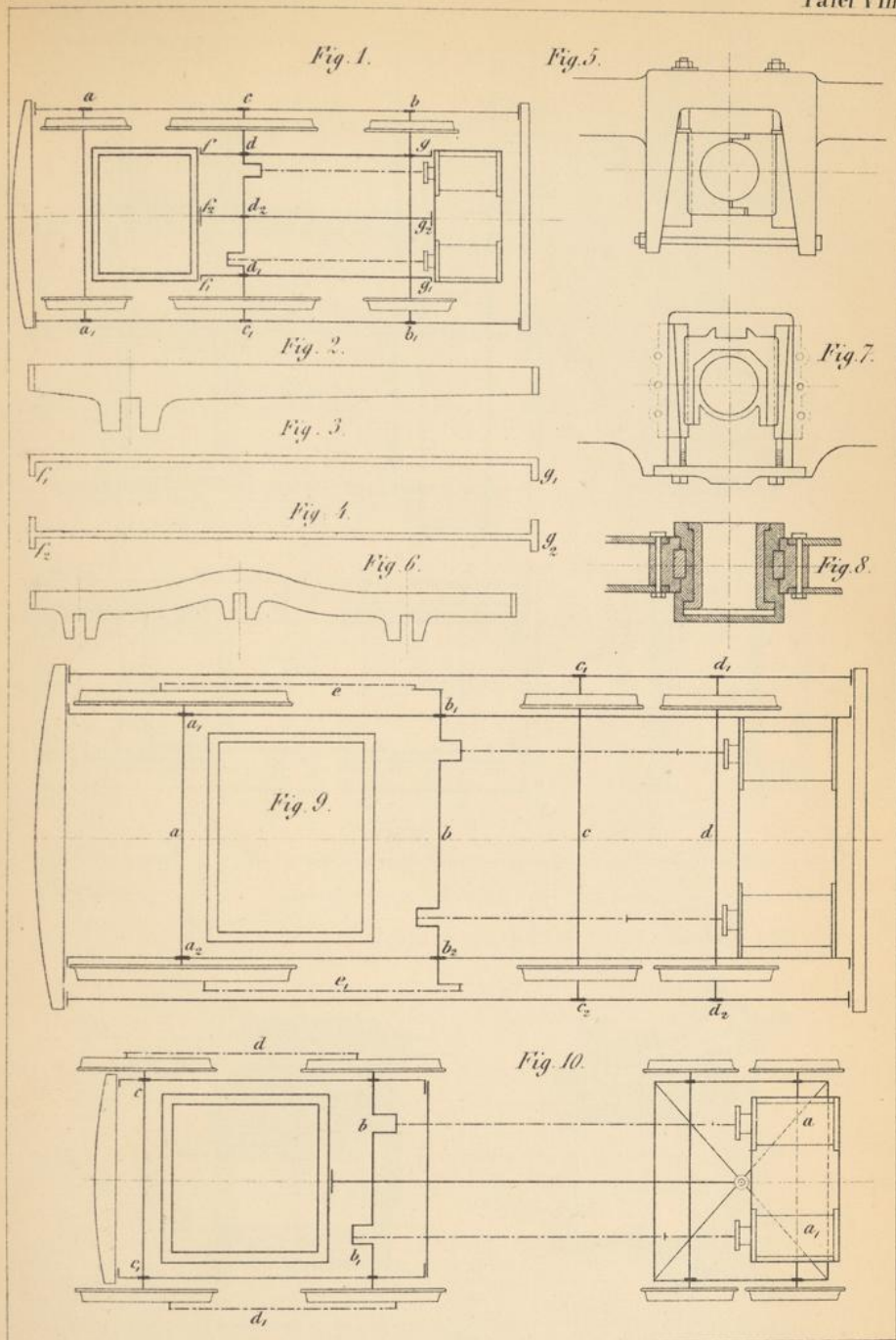
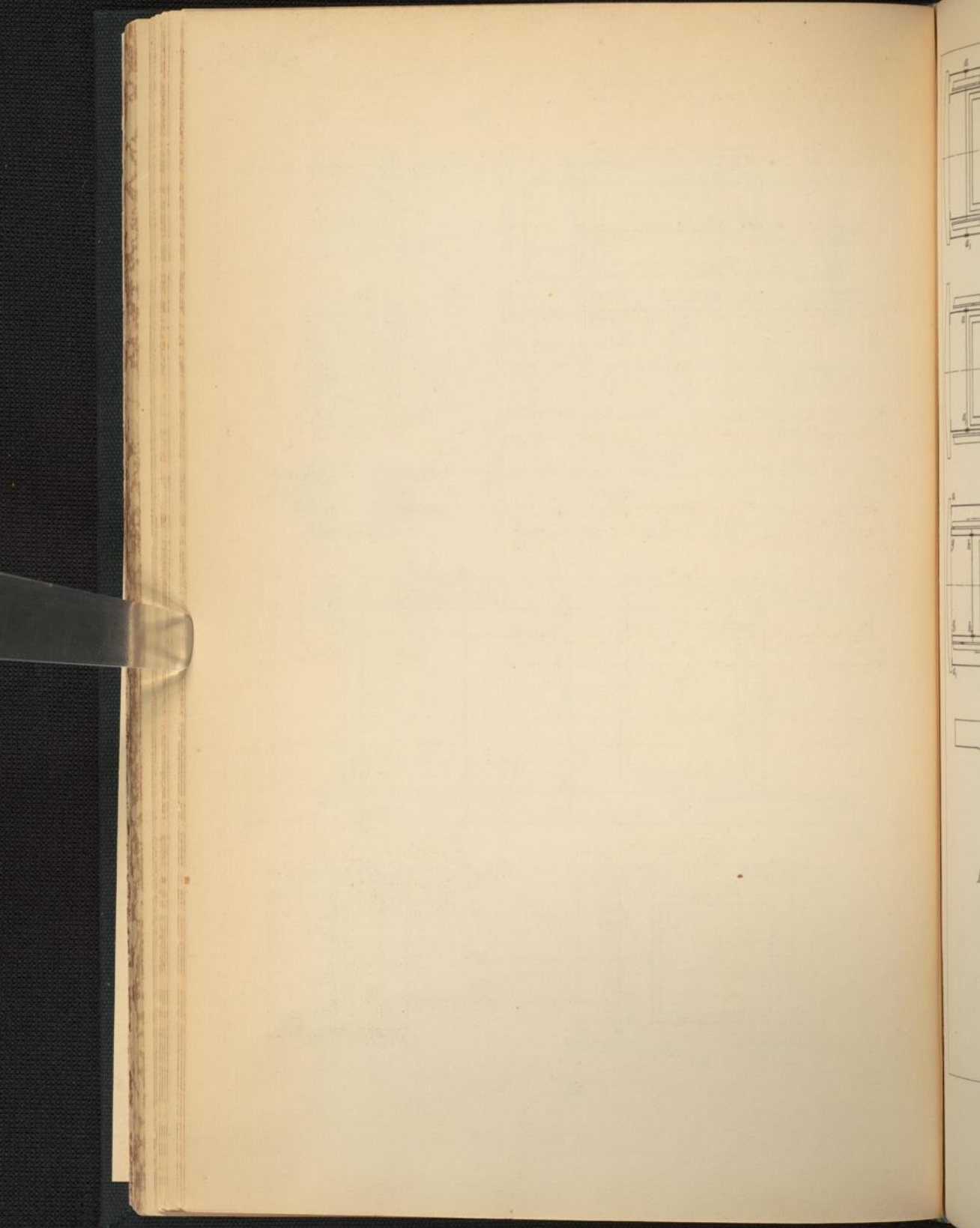


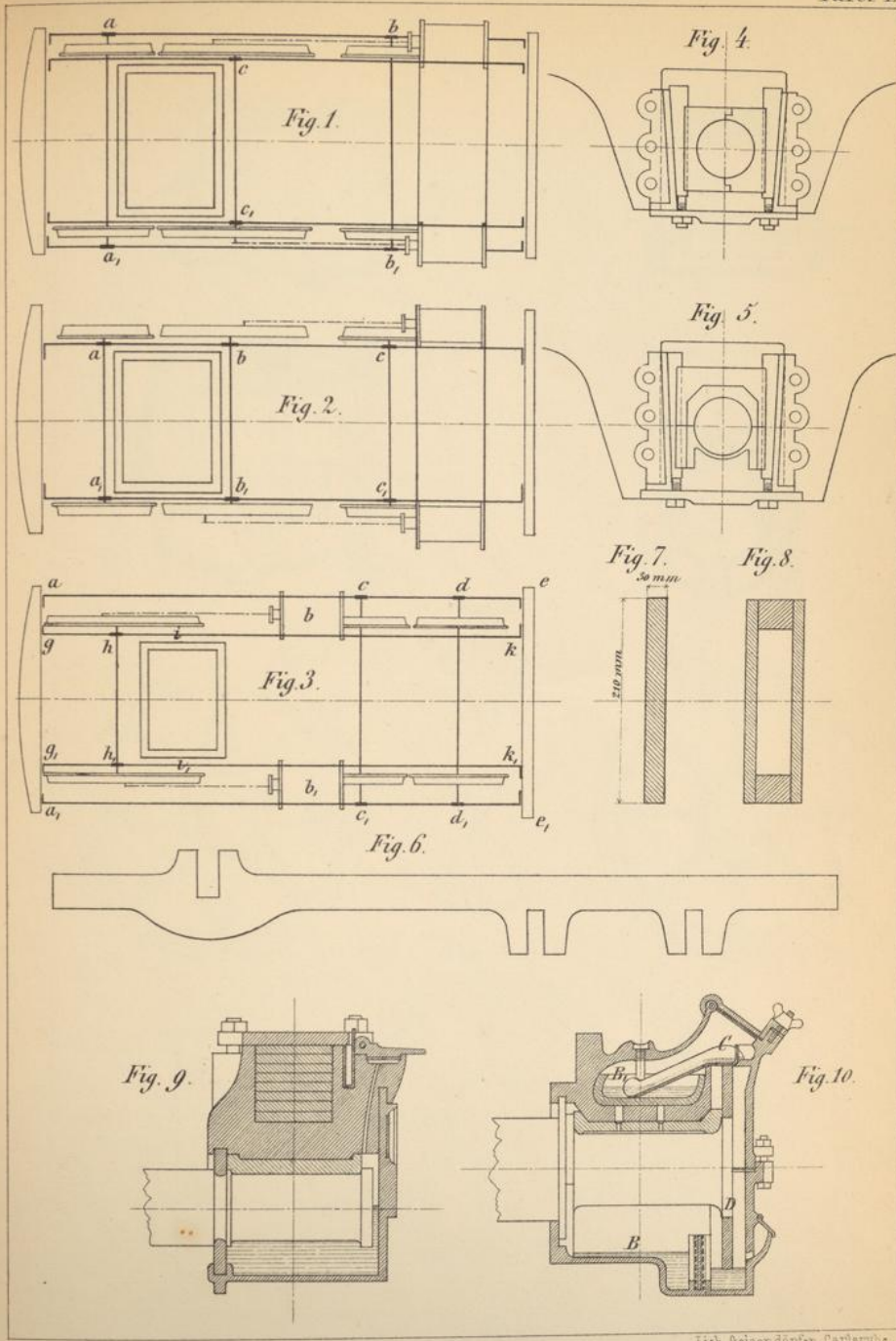
Fig. 17.

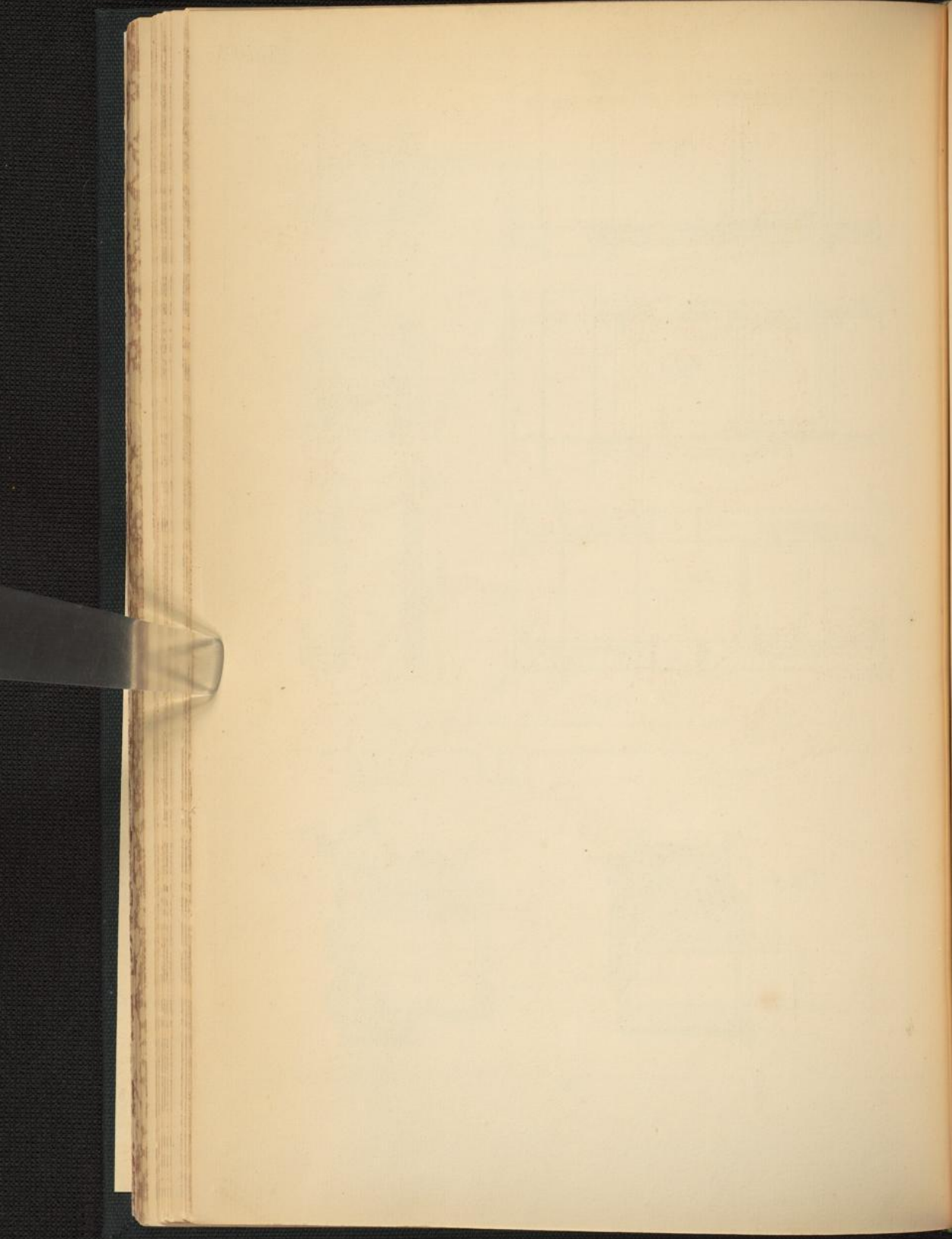


Hint. Axenb.









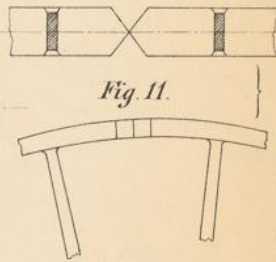
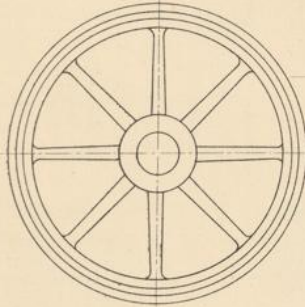
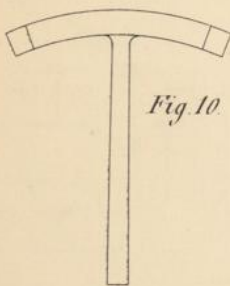
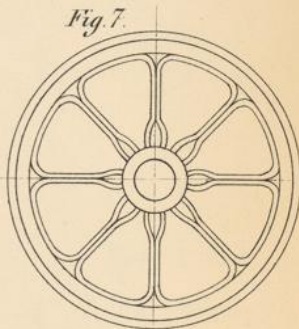
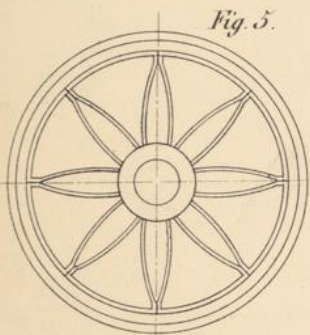
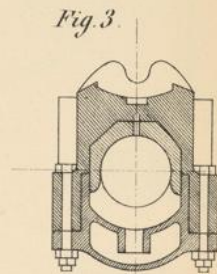
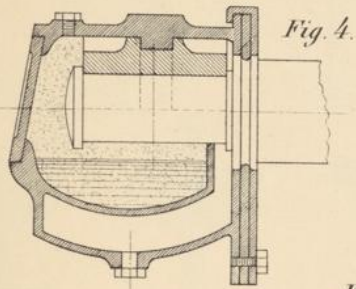
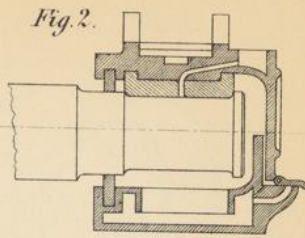
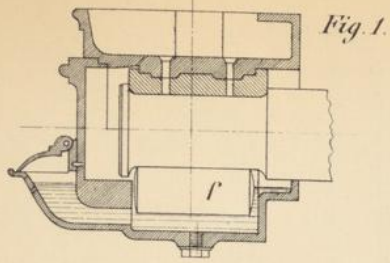


Fig. 1.

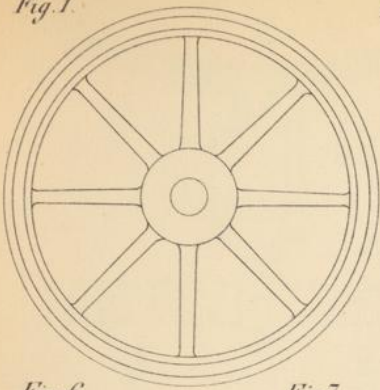


Fig. 2.

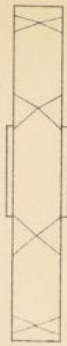


Fig. 3.

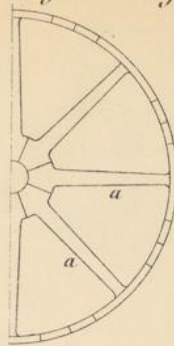


Fig. 4.

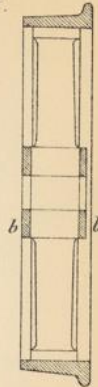


Fig. 6.

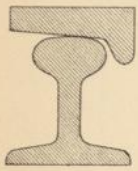


Fig. 7.

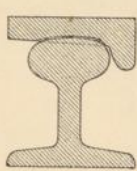


Fig. 8.

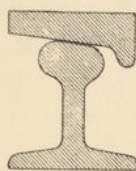


Fig. 5.

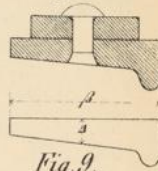


Fig. 10.

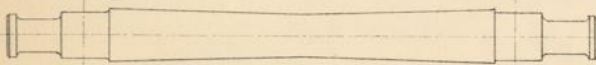


Fig. 11.



Fig. 12.

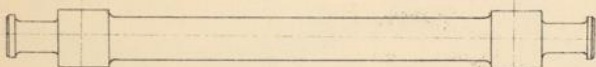


Fig. 13.

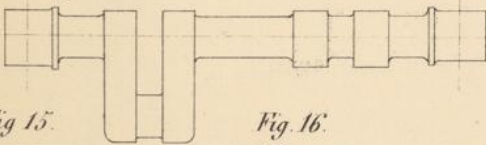


Fig. 15.

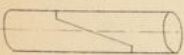


Fig. 16.



Fig. 17.

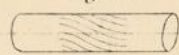
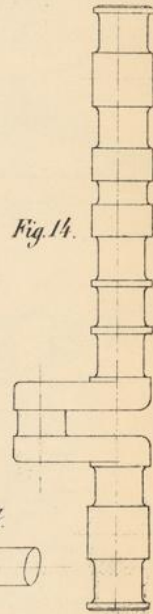
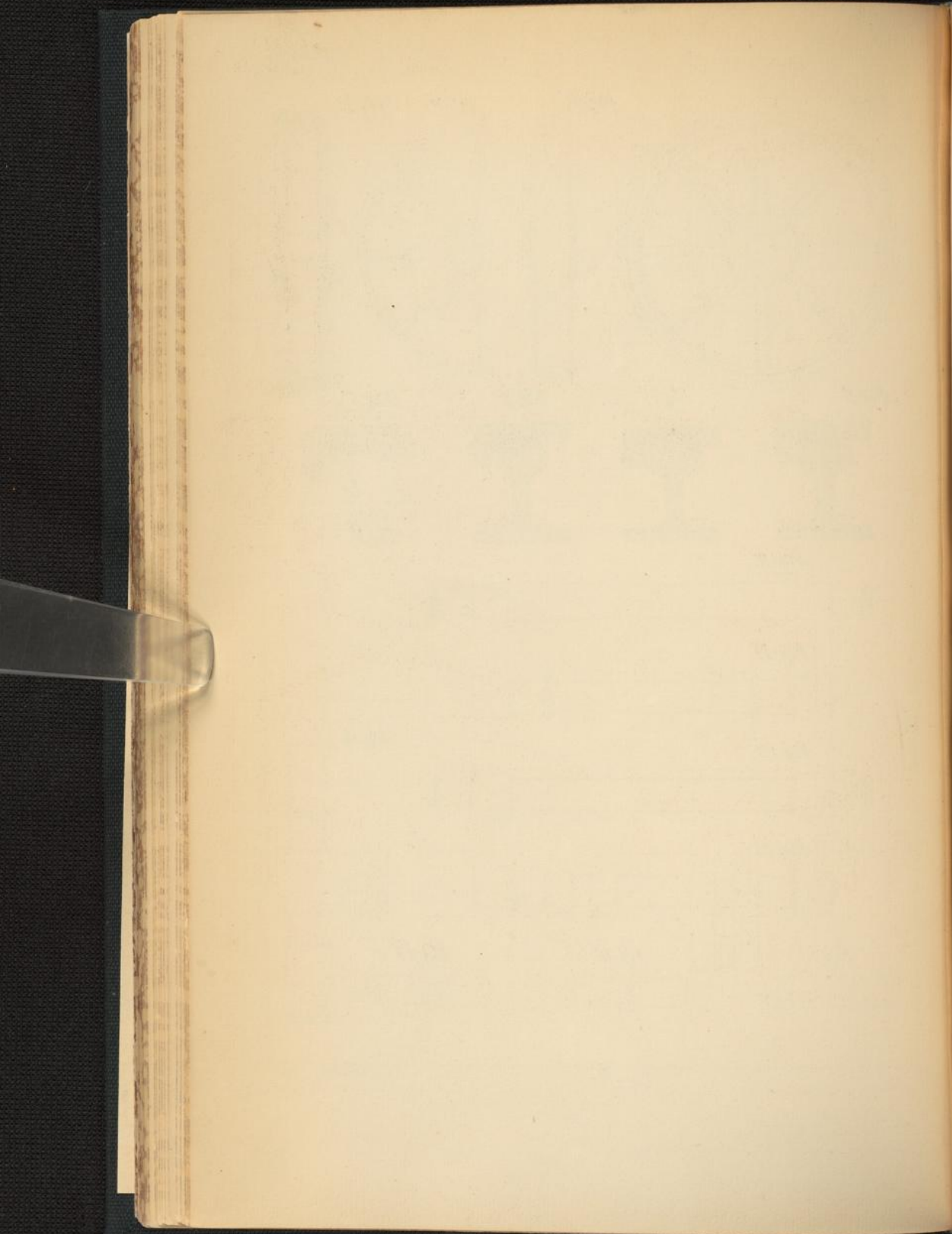


Fig. 14.





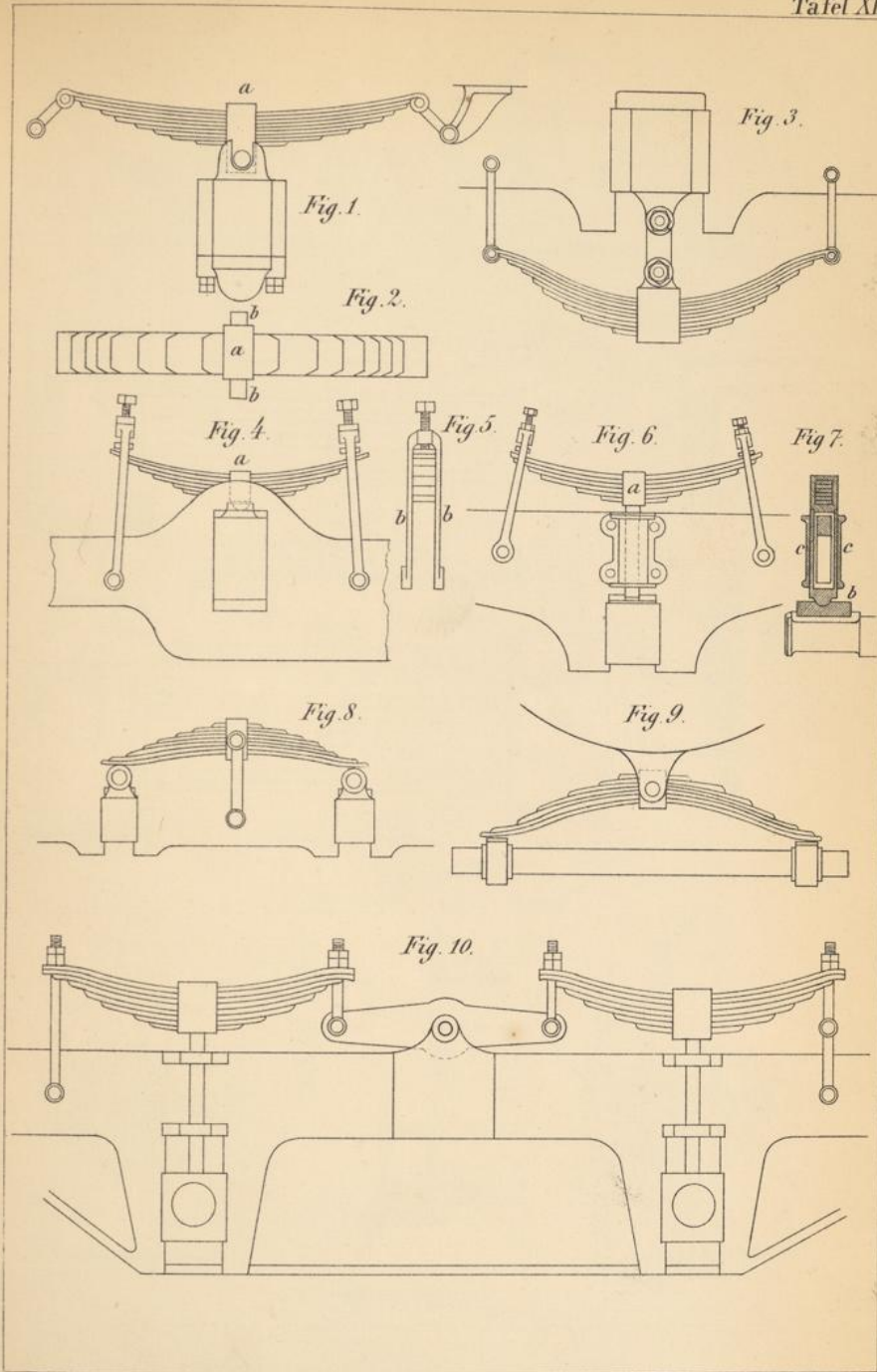


Fig. 1.

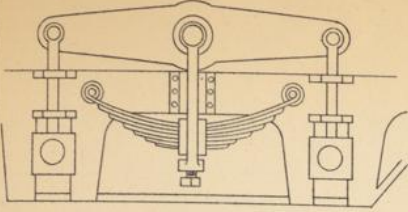


Fig. 2.

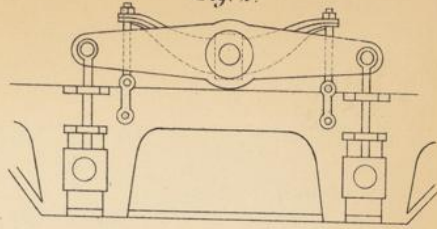


Fig. 3.



Fig. 7.

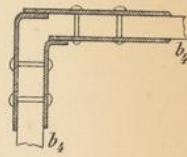


Fig. 9.

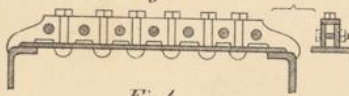


Fig. 4.

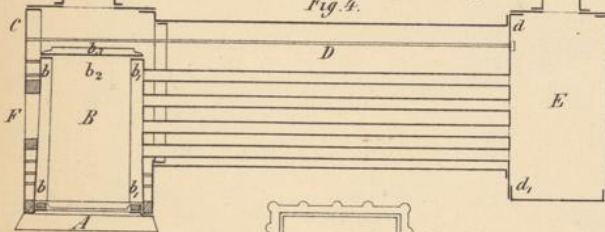


Fig. 8.



Fig. 10.



Fig. 13.



Fig. 5.

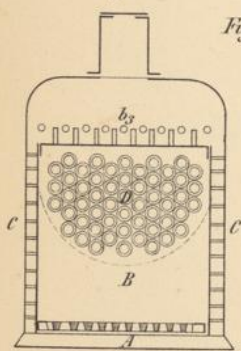


Fig. 11.

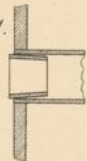


Fig. 12.

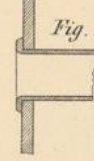


Fig. 6.

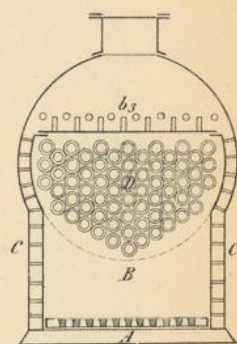
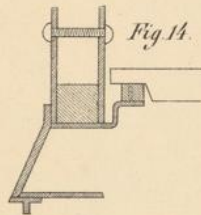


Fig. 14.



Lith. H. Geisendorfer, Karlsruhe

Fig. 1.

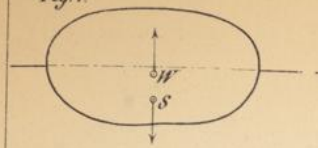


Fig. 2.

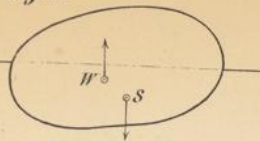


Fig. 3.

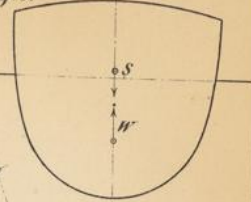


Fig. 4.

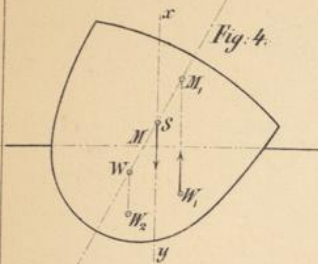


Fig. 5.

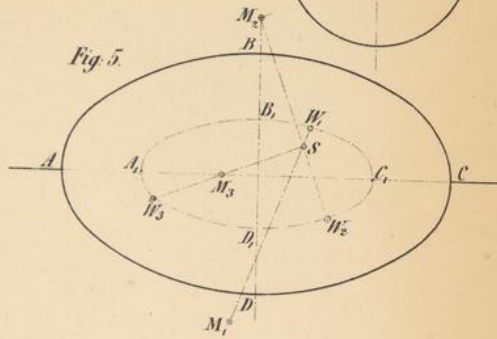


Fig. 6.

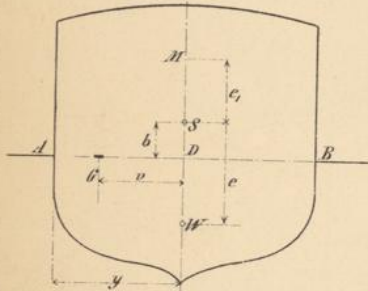


Fig. 7.

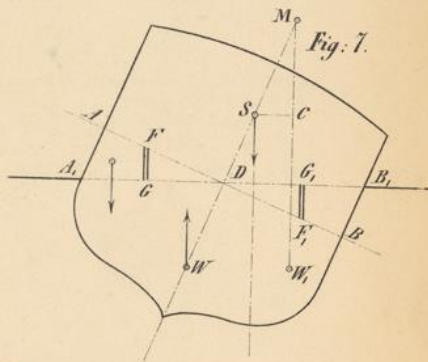
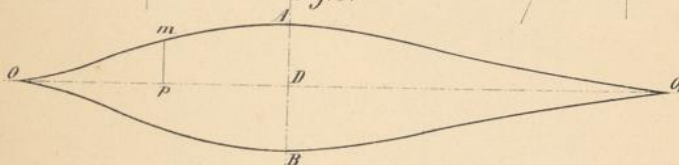


Fig. 8.



Ver. 10 8 6 4 2 0 20 18 16 14 12 10 deck

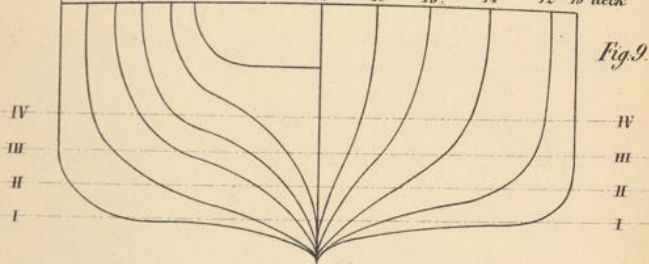
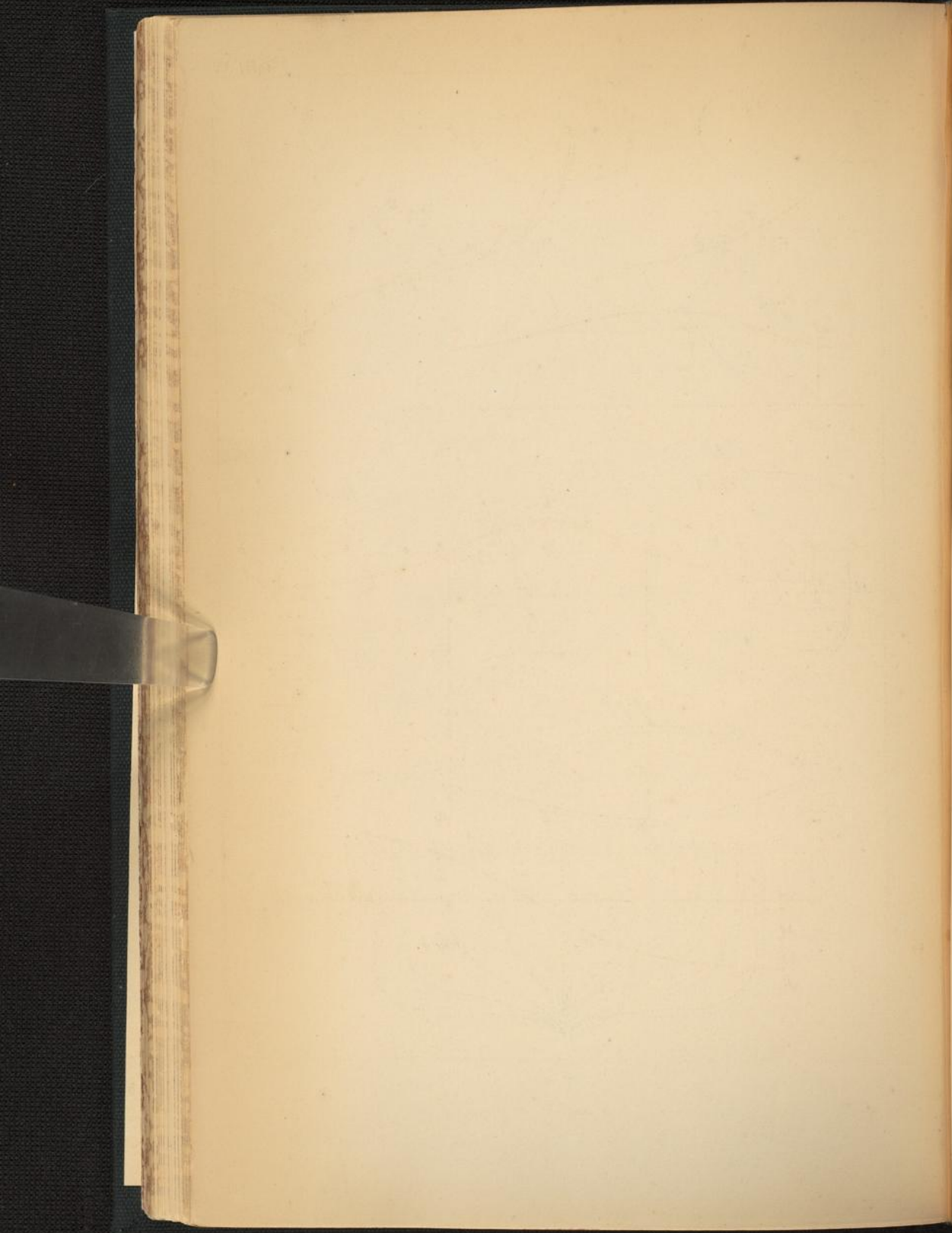
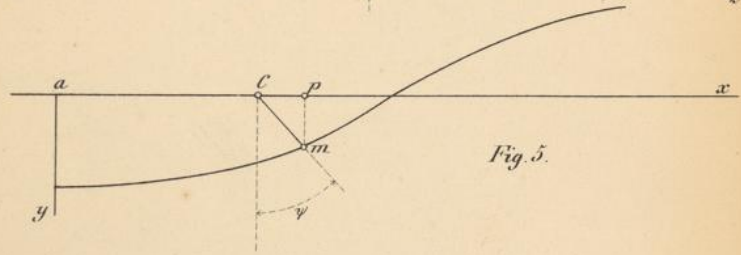
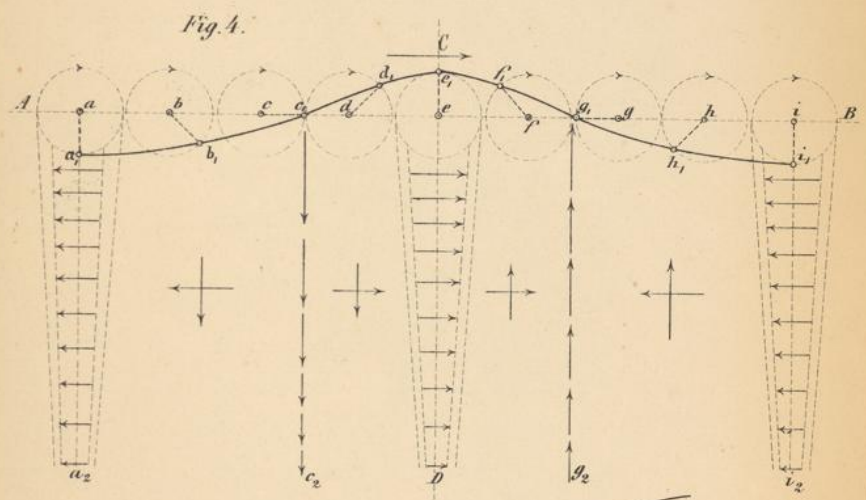
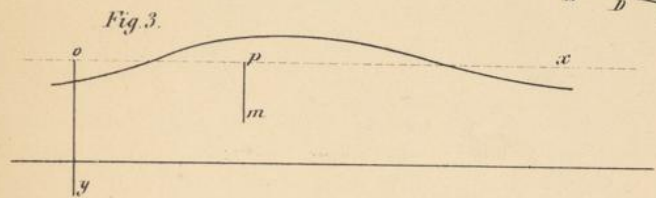
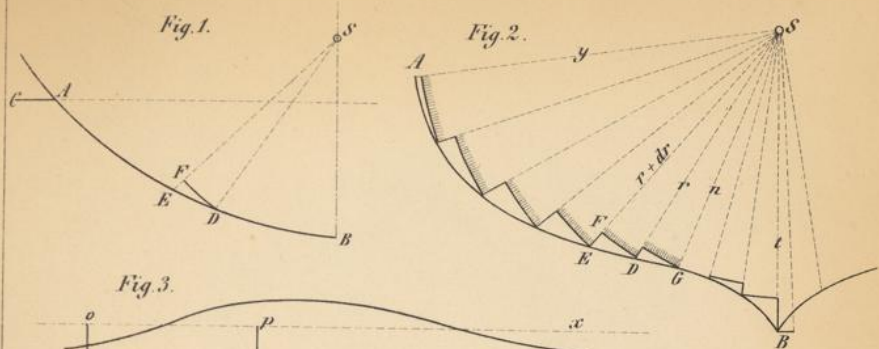


Fig. 9.

Lith. L. Gessendörfer





Lith. L. Geisendorfer, Carlsruhe.



Fig. 1.

Gelassene Wellen.
(gestreckte Cycloide.)

$\zeta = \frac{1}{3} \lambda$

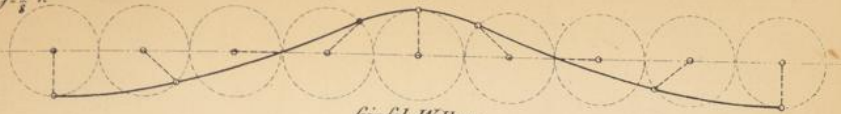


Fig. 2.

Gipfel Wellen.
(gestreckte Cycloide)

$\zeta = \frac{1}{3} \lambda$

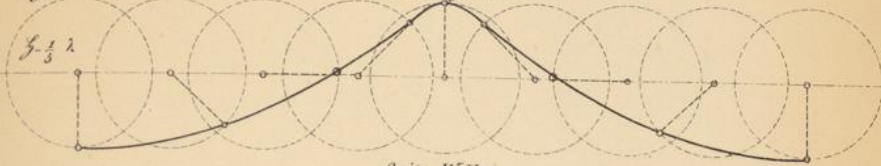


Fig. 3.

Spitz-Wellen
(Cycloide.)

$\zeta = \frac{1}{3,4} \lambda$

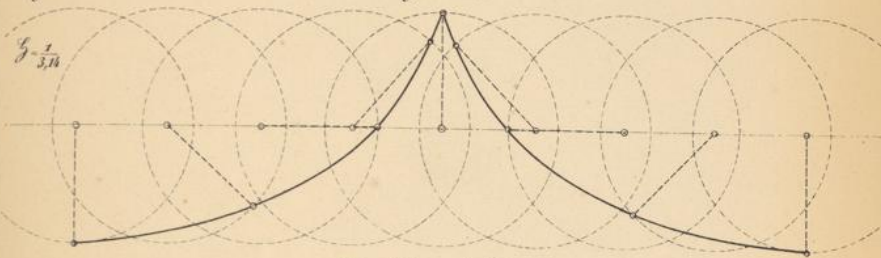


Fig. 4.

Überschlagende Wellen
(geschlungene Cycloide)

$\zeta = \frac{1}{2} \lambda$

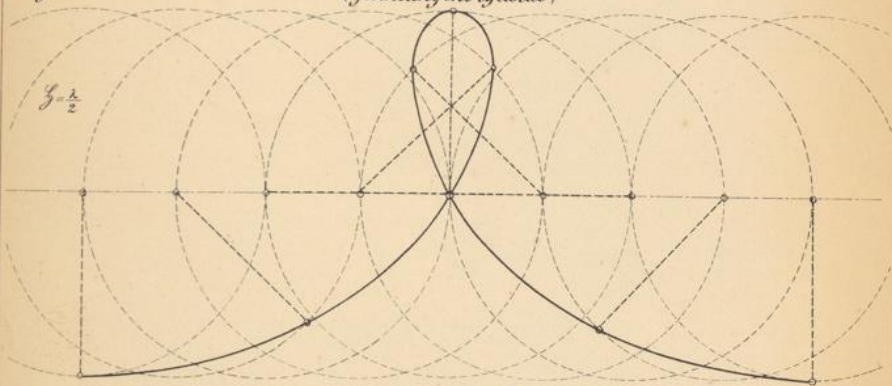


Fig. 5.

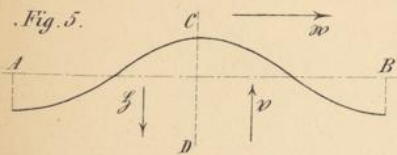
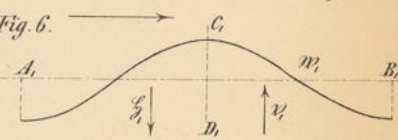


Fig. 6.



Lith. L. Geisenhoffer, Carlsruhe



Partial view of the adjacent page showing faint handwritten text and a diagram with curved lines.

Fig. 1.

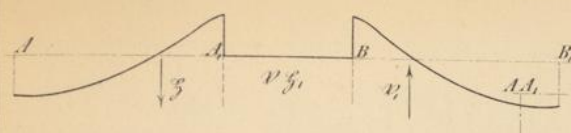


Fig. 2.

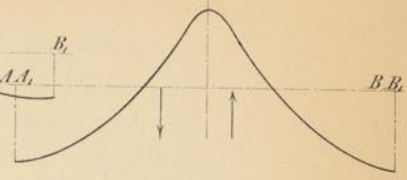


Fig. 3.

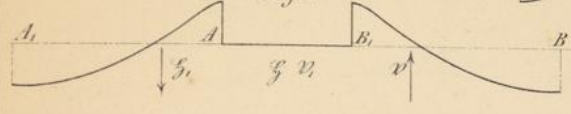


Fig. 6.

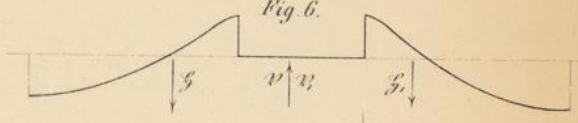


Fig. 4.



Fig. 5.

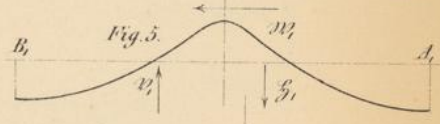


Fig. 8.

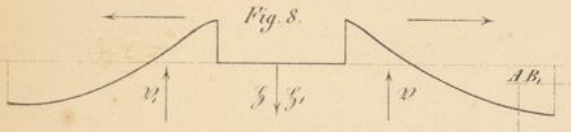


Fig. 7.

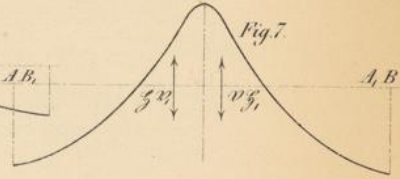


Fig. 9.

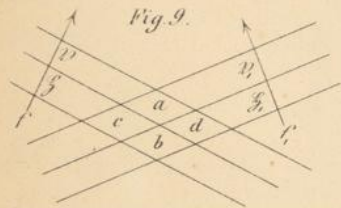


Fig. 10.

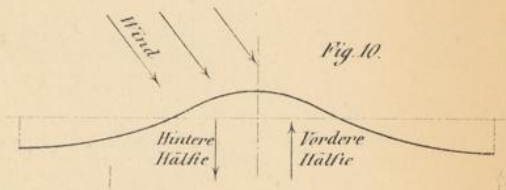


Fig. 11.

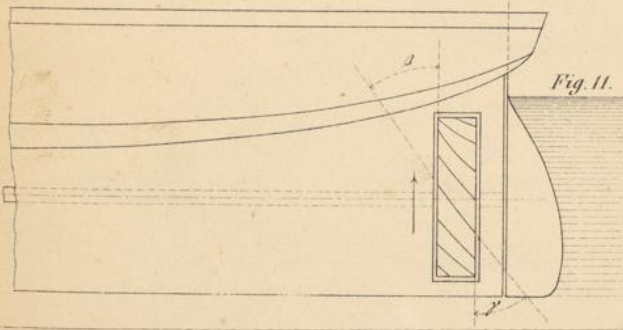
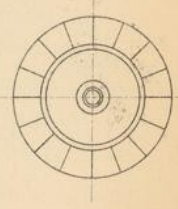
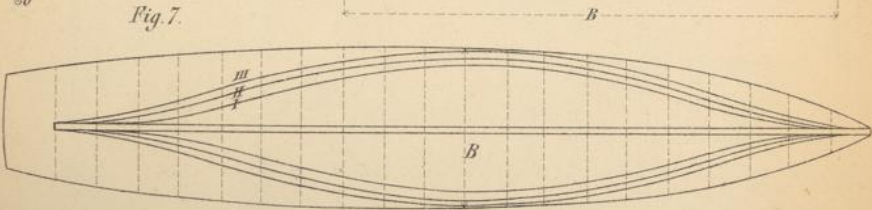
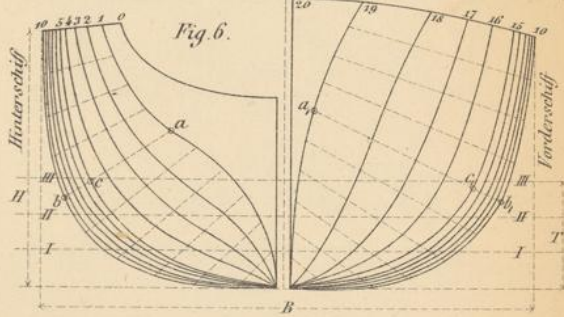
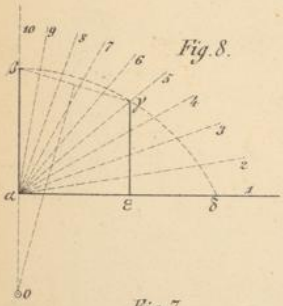
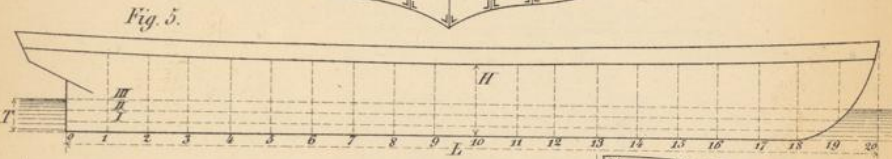
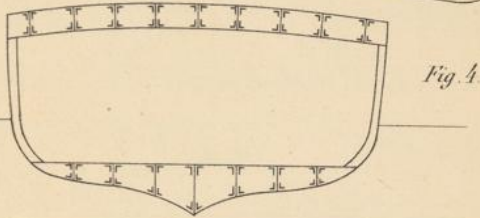
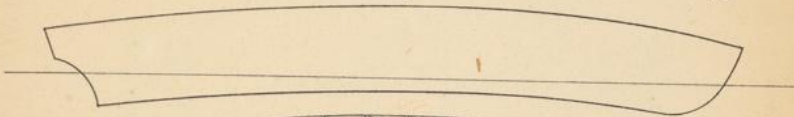
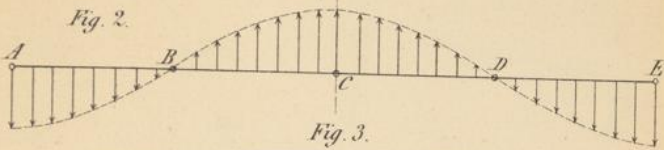
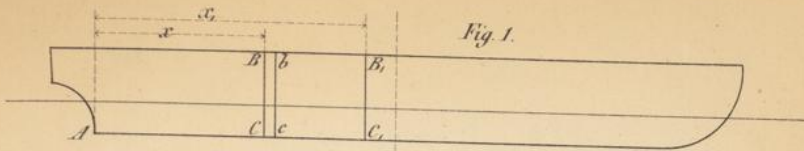
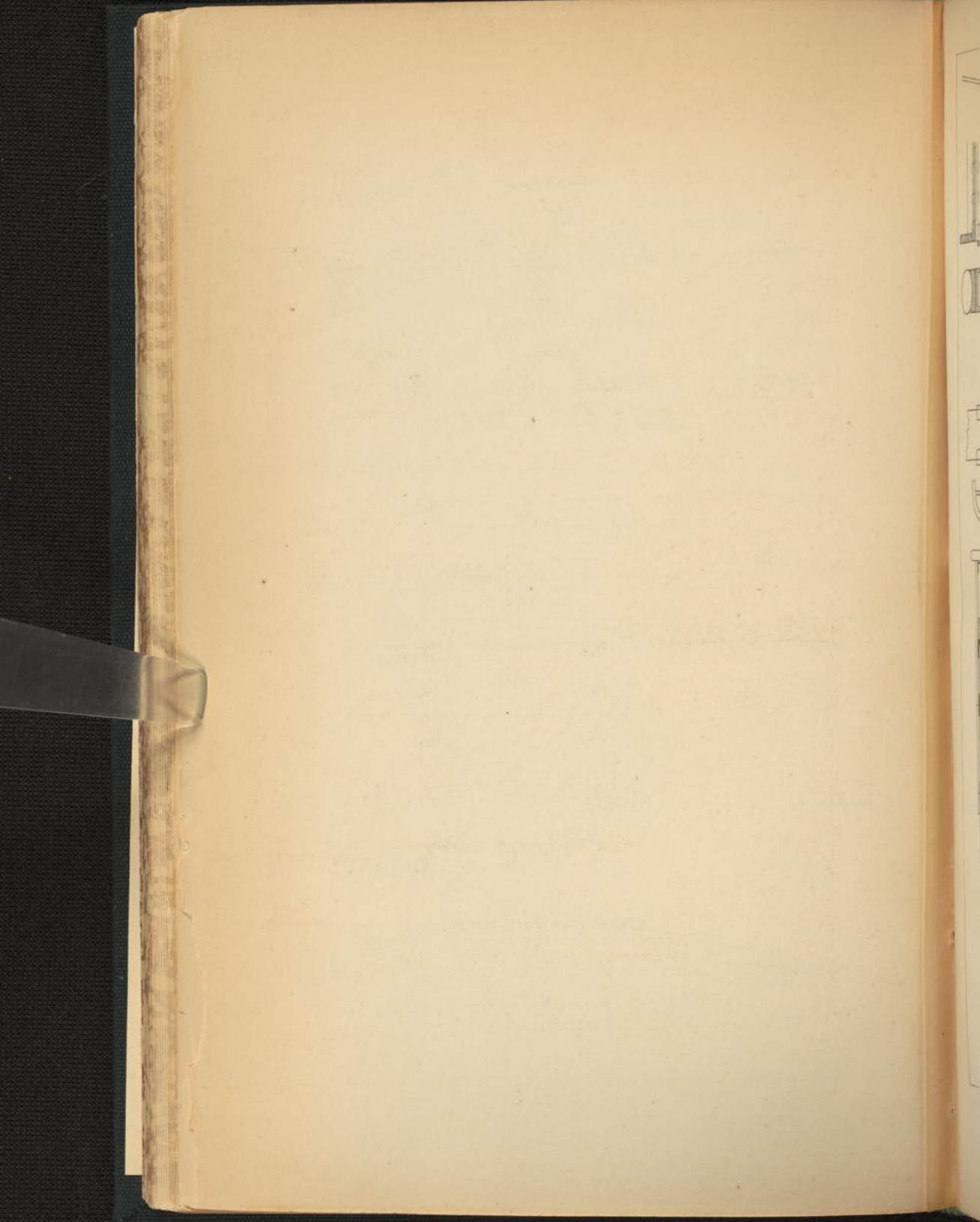


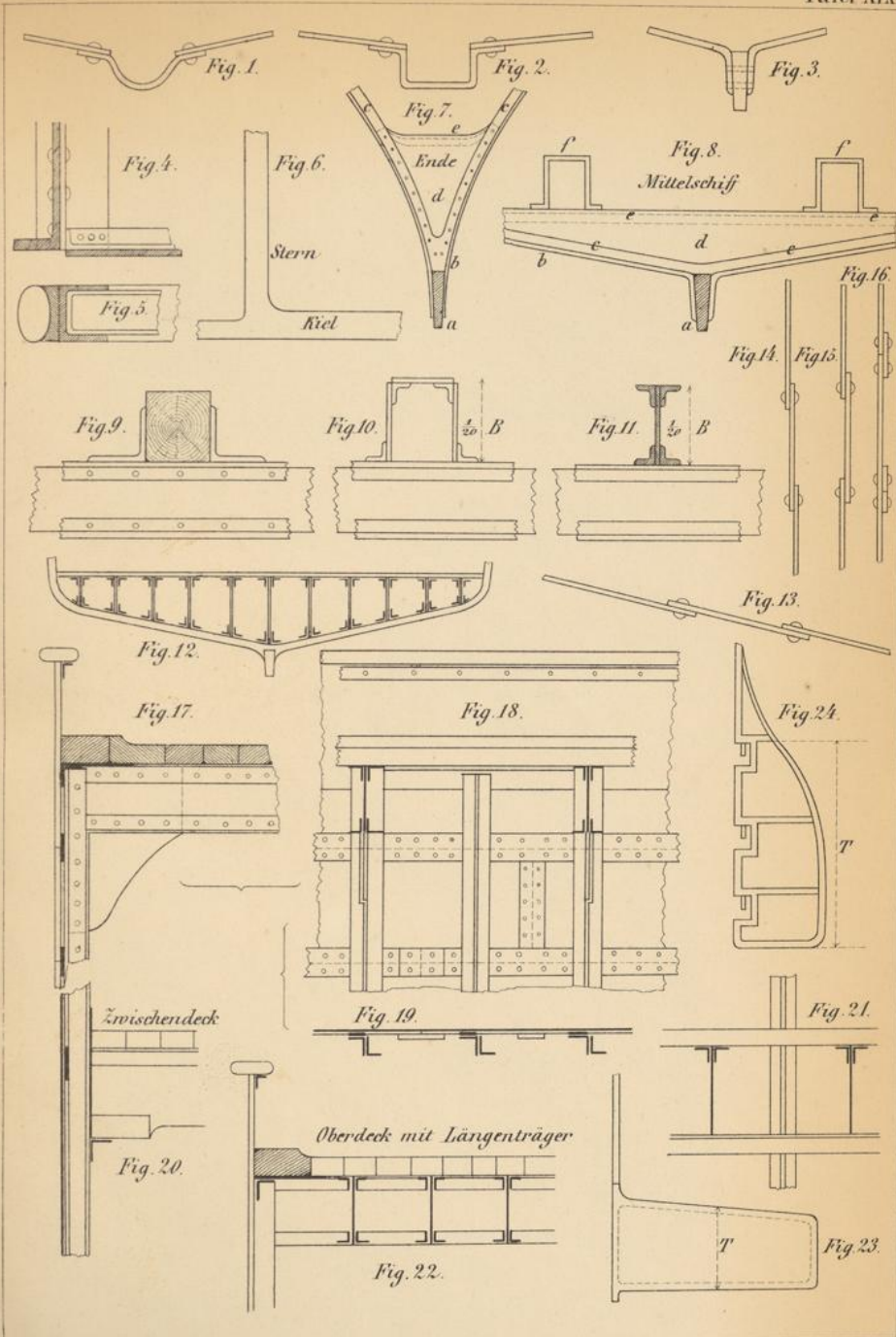
Fig. 12.



III







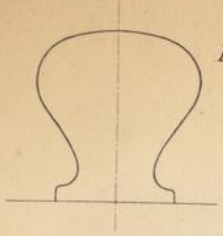


Fig. 1.



Fig. 4.

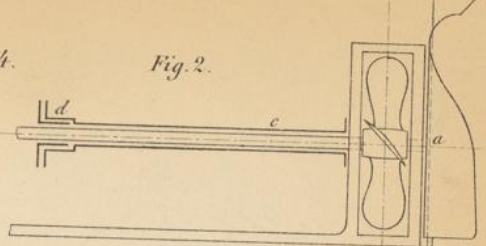


Fig. 2.

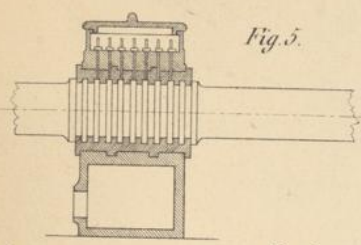


Fig. 5.

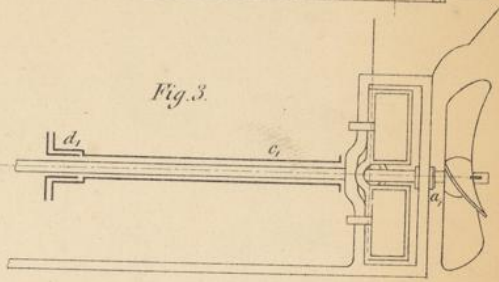


Fig. 3.

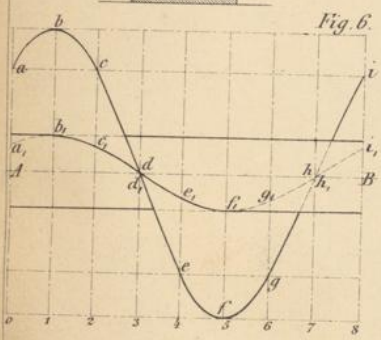


Fig. 6.

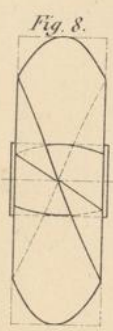


Fig. 8.



Fig. 9.

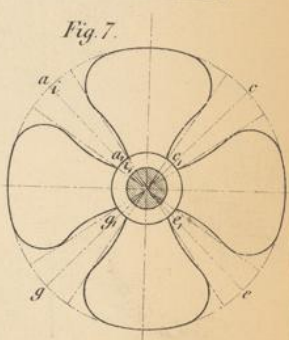


Fig. 7.

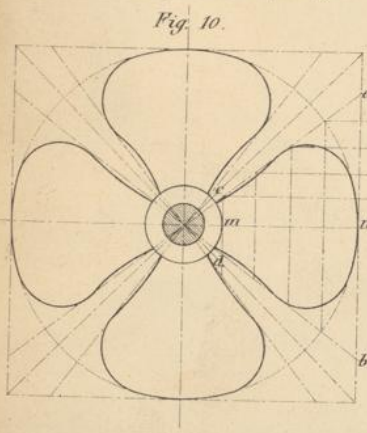


Fig. 10.

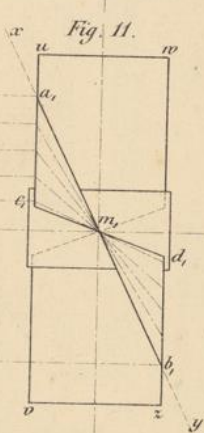


Fig. 11.

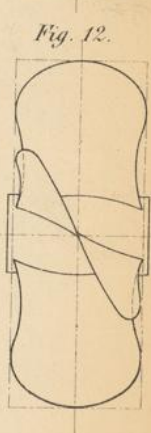
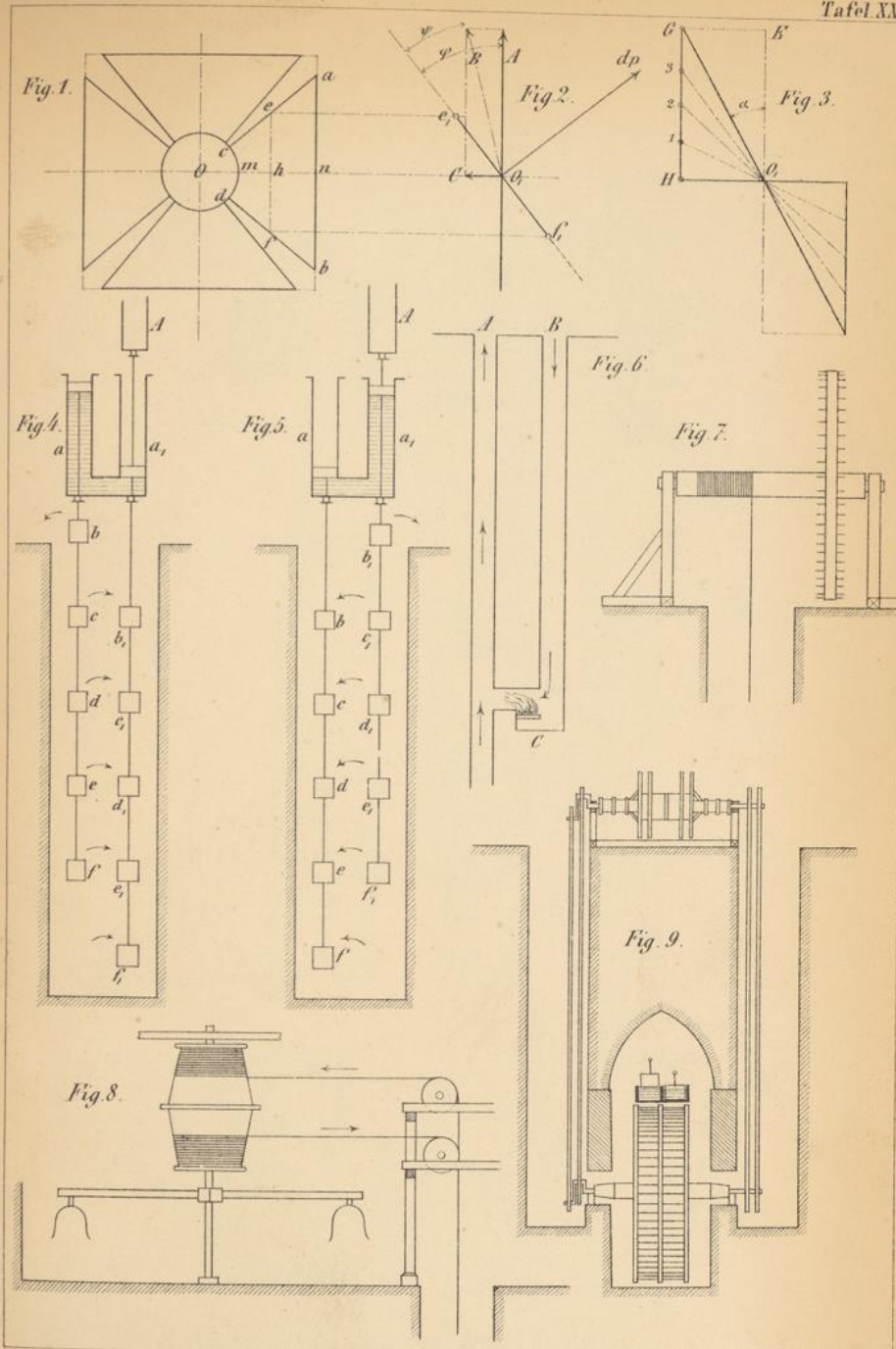
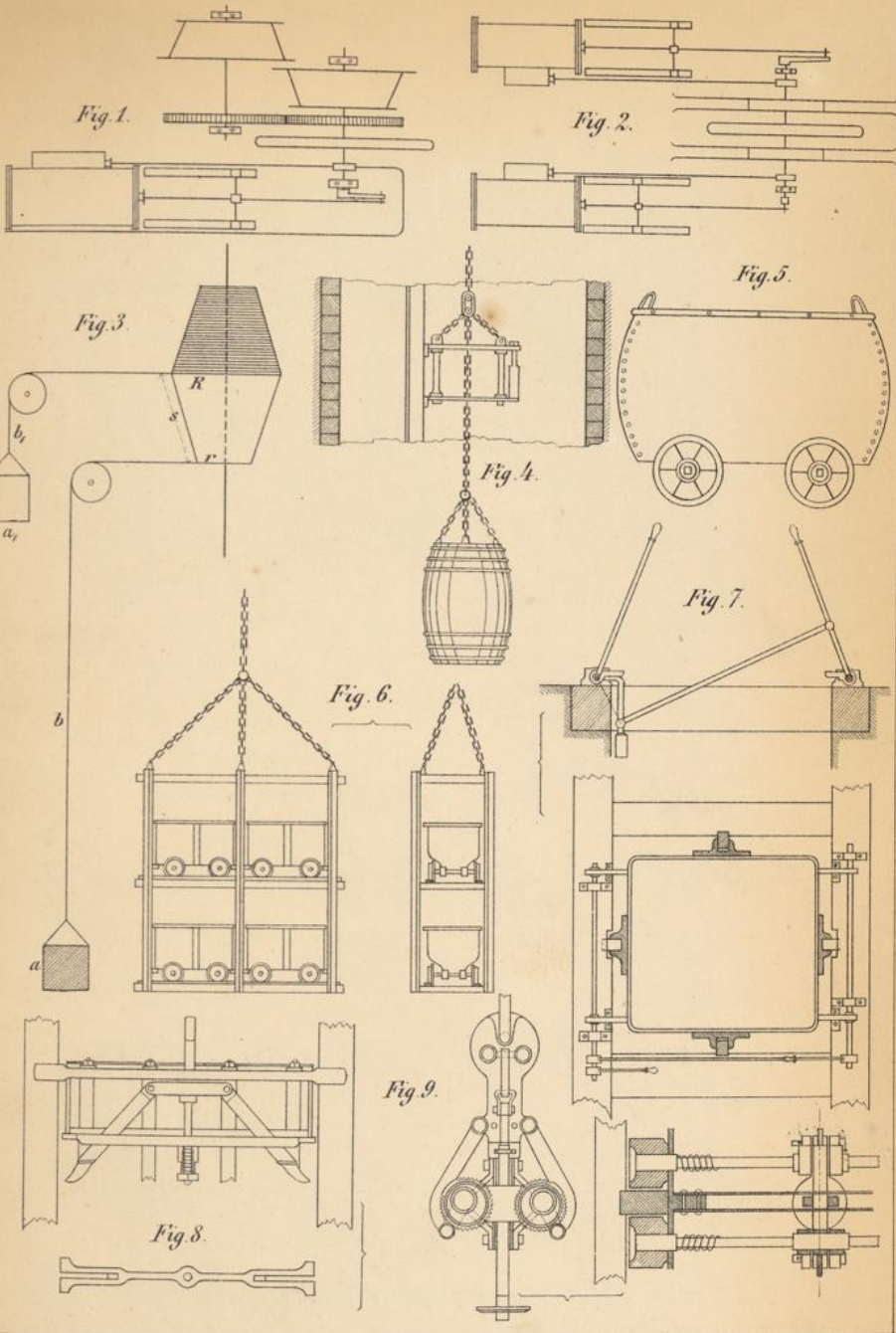
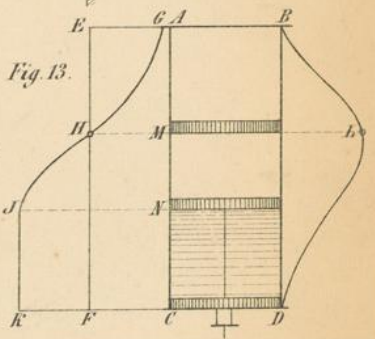
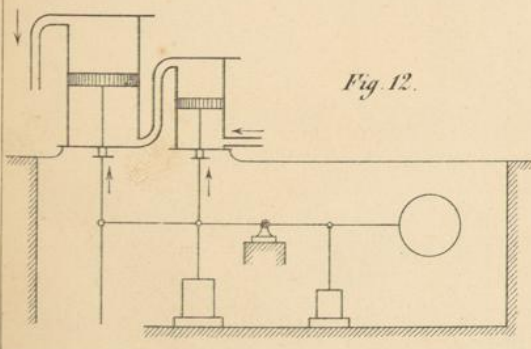
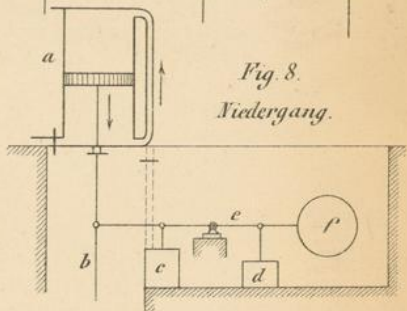
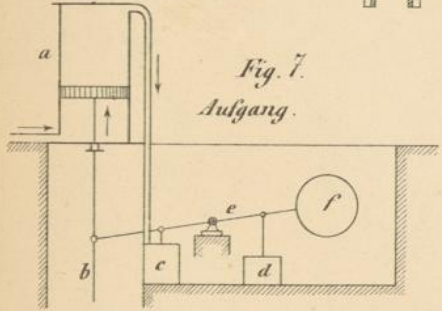
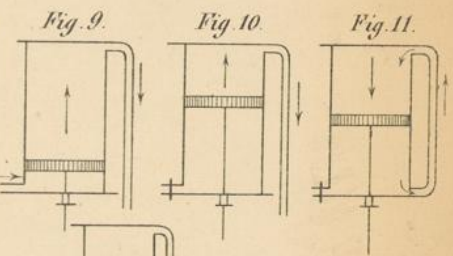
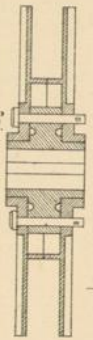
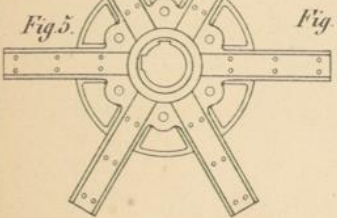
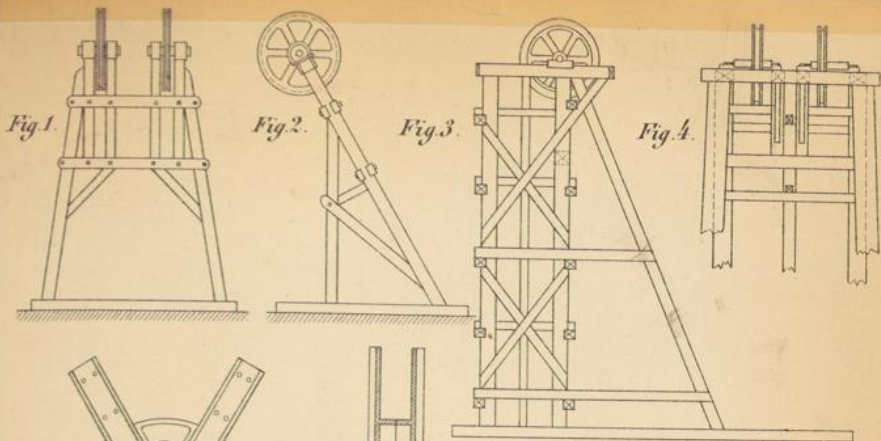


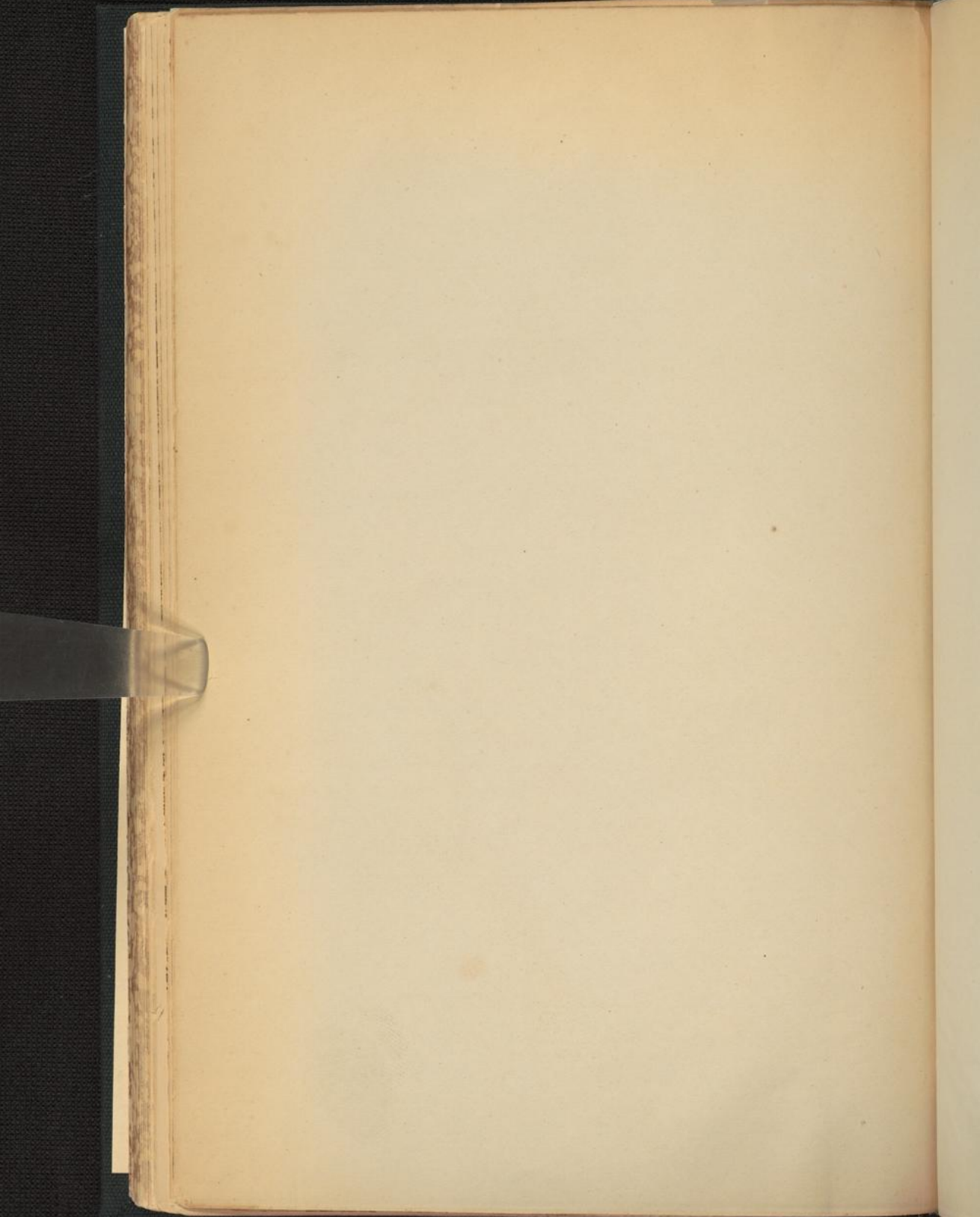
Fig. 12.

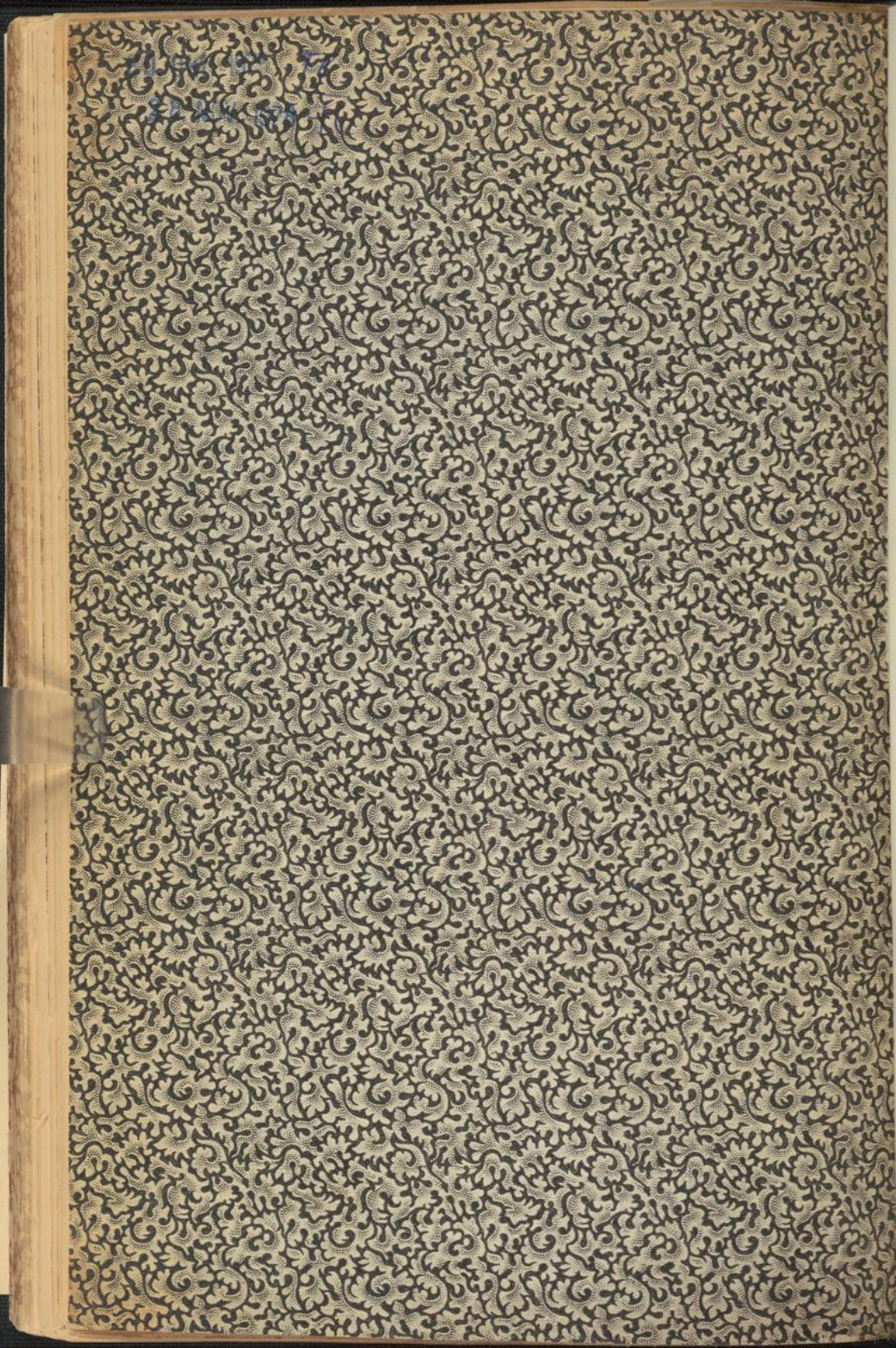






12 877070







N11< 44822324 090

UB Karlsruhe



