

# **Badische Landesbibliothek Karlsruhe**

**Digitale Sammlung der Badischen Landesbibliothek Karlsruhe**

## **Der Maschinenbau**

Tafeln zu Bd. 1 - 3

**Redtenbacher, Ferdinand**

**Mannheim, 1862 - 1865**

[Band 1]

[urn:nbn:de:bsz:31-278587](https://nbn-resolving.org/urn:nbn:de:bsz:31-278587)

Fig. 1.

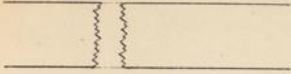

Fig. 2.

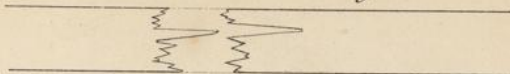

Fig. 3.

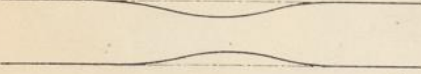

Fig. 4.



Fig. 6.

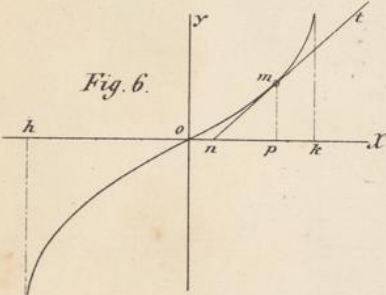

Fig. 5.

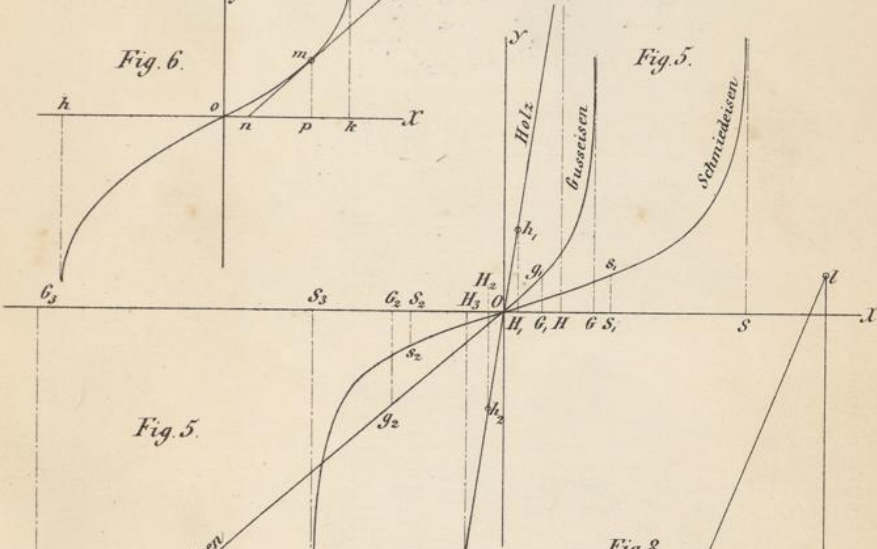

Fig. 5.

Guss-eisen

Fig. 9.

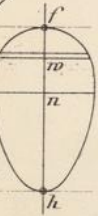

Fig. 8.

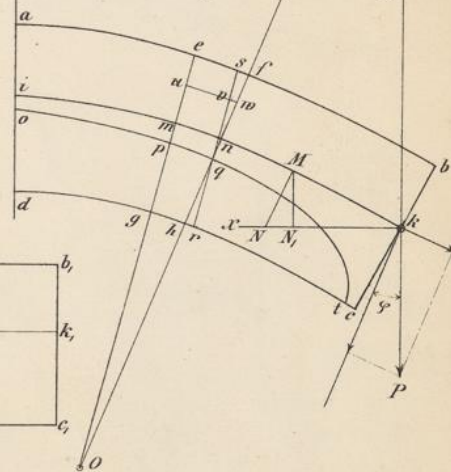
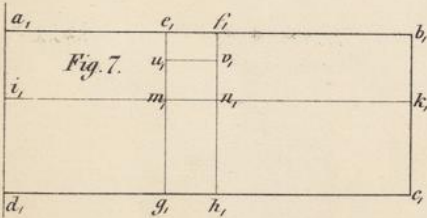

Fig. 7.





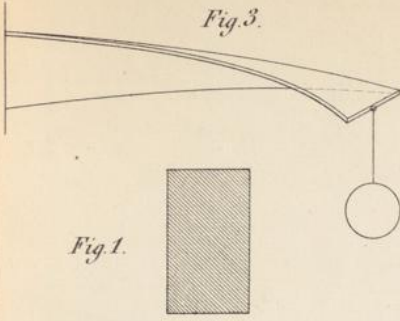

Fig. 1.

Fig. 3.

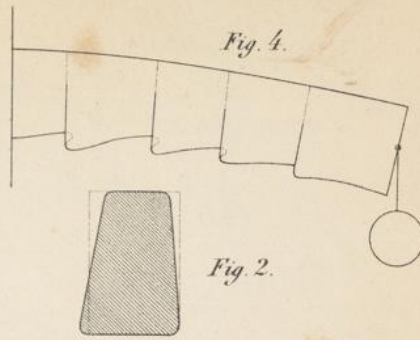

Fig. 2.

Fig. 4.

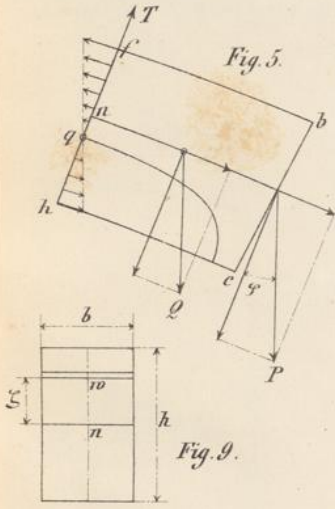

Fig. 5.

Fig. 9.

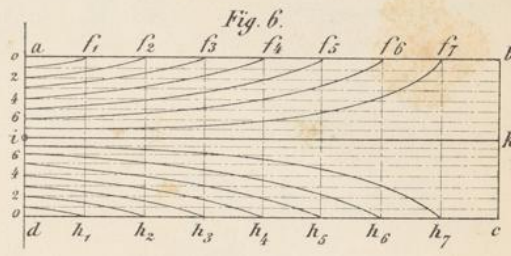

Fig. 6.

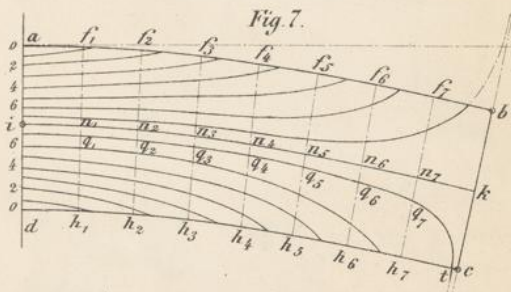

Fig. 7.

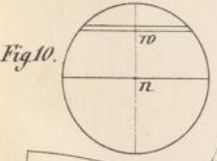

Fig. 10.

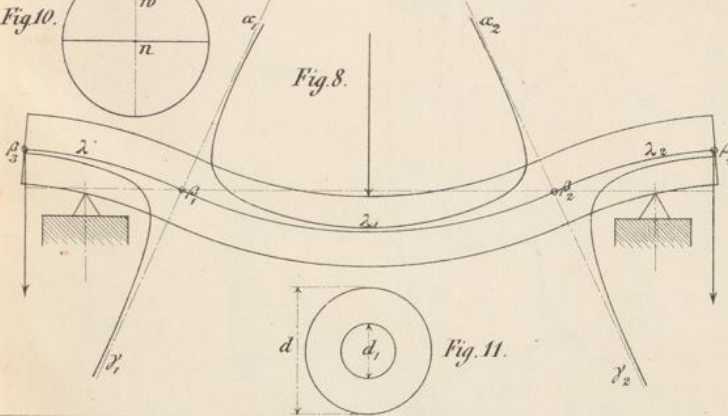

Fig. 8.

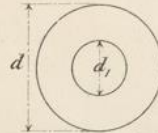

Fig. 11.

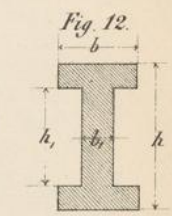

Fig. 12.

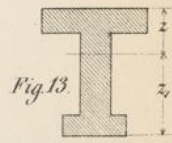
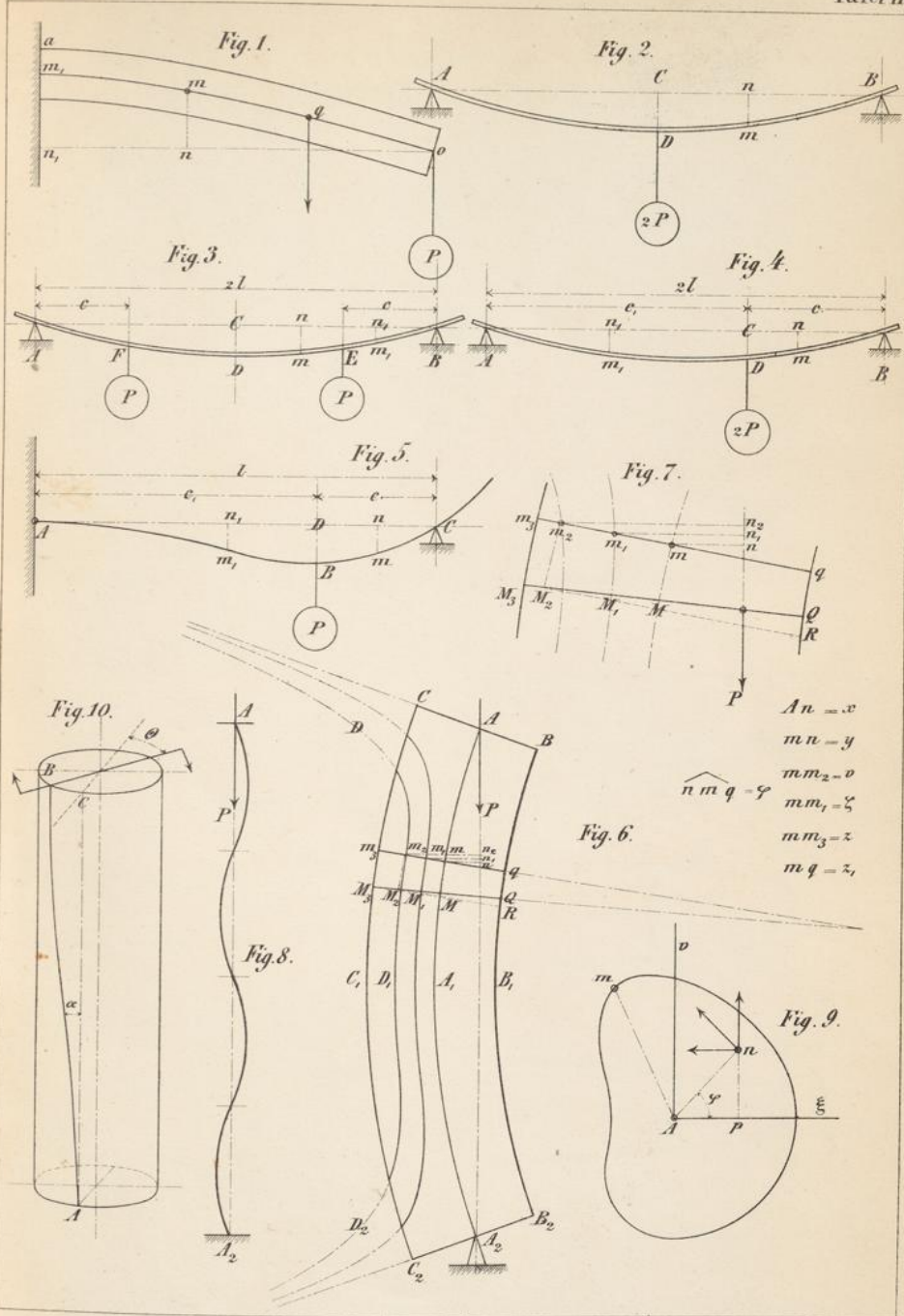

Fig. 13.





$$\begin{aligned}
 An &= x \\
 mn &= y \\
 \widehat{nmq} &= \varphi \\
 mm_2 &= \rho \\
 mm_1 &= \zeta \\
 mm_3 &= z \\
 mq &= z_1
 \end{aligned}$$

Fig. 6.

Fig. 9.



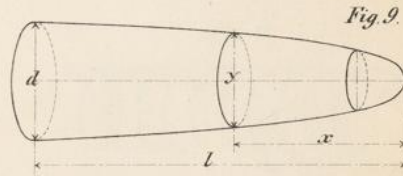
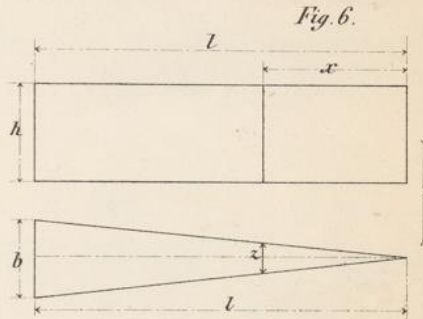
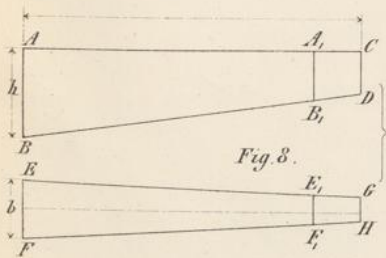
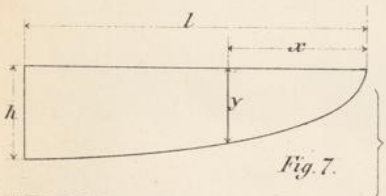
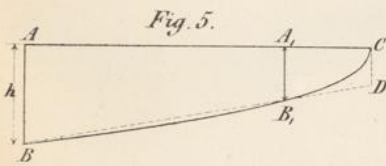
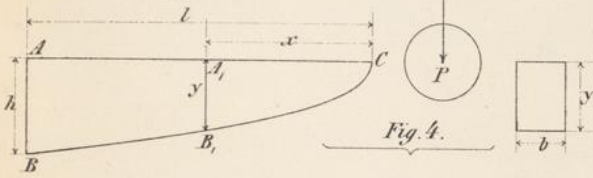
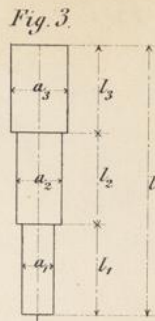
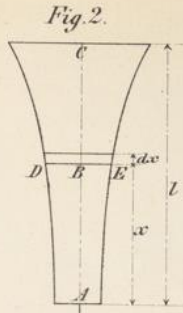
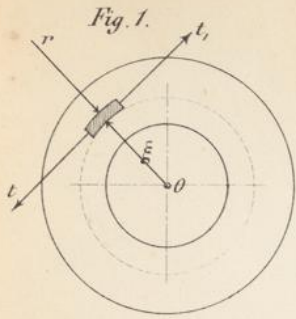



Fig. 1



Fig. 2



Fig. 3

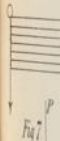

Fig. 4



Fig. 5



Fig. 6



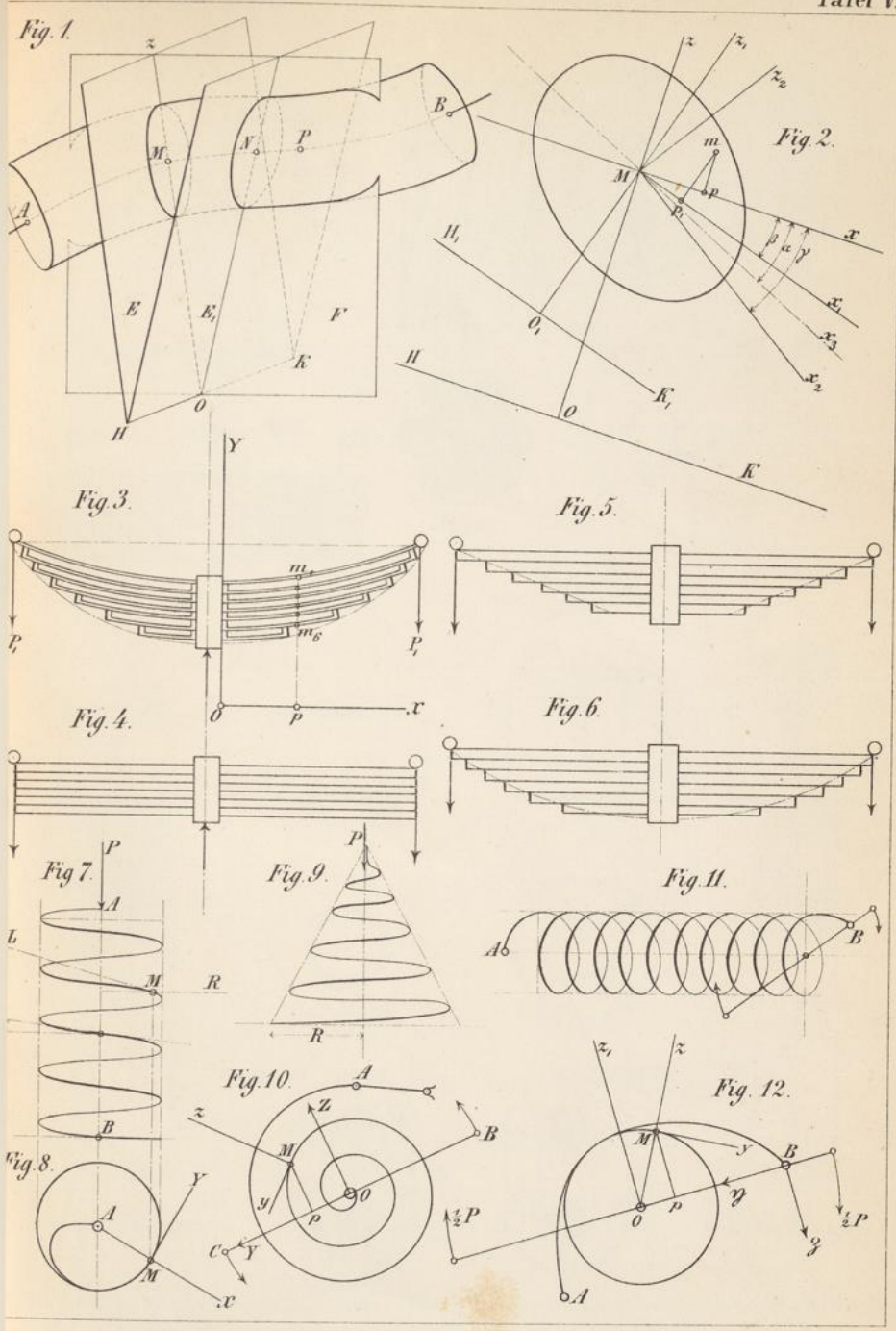

Fig. 1.

Fig. 2.

Fig. 3.

Fig. 5.

Fig. 4.

Fig. 6.

Fig. 7.

Fig. 9.

Fig. 11.

Fig. 8.

Fig. 10.

Fig. 12.



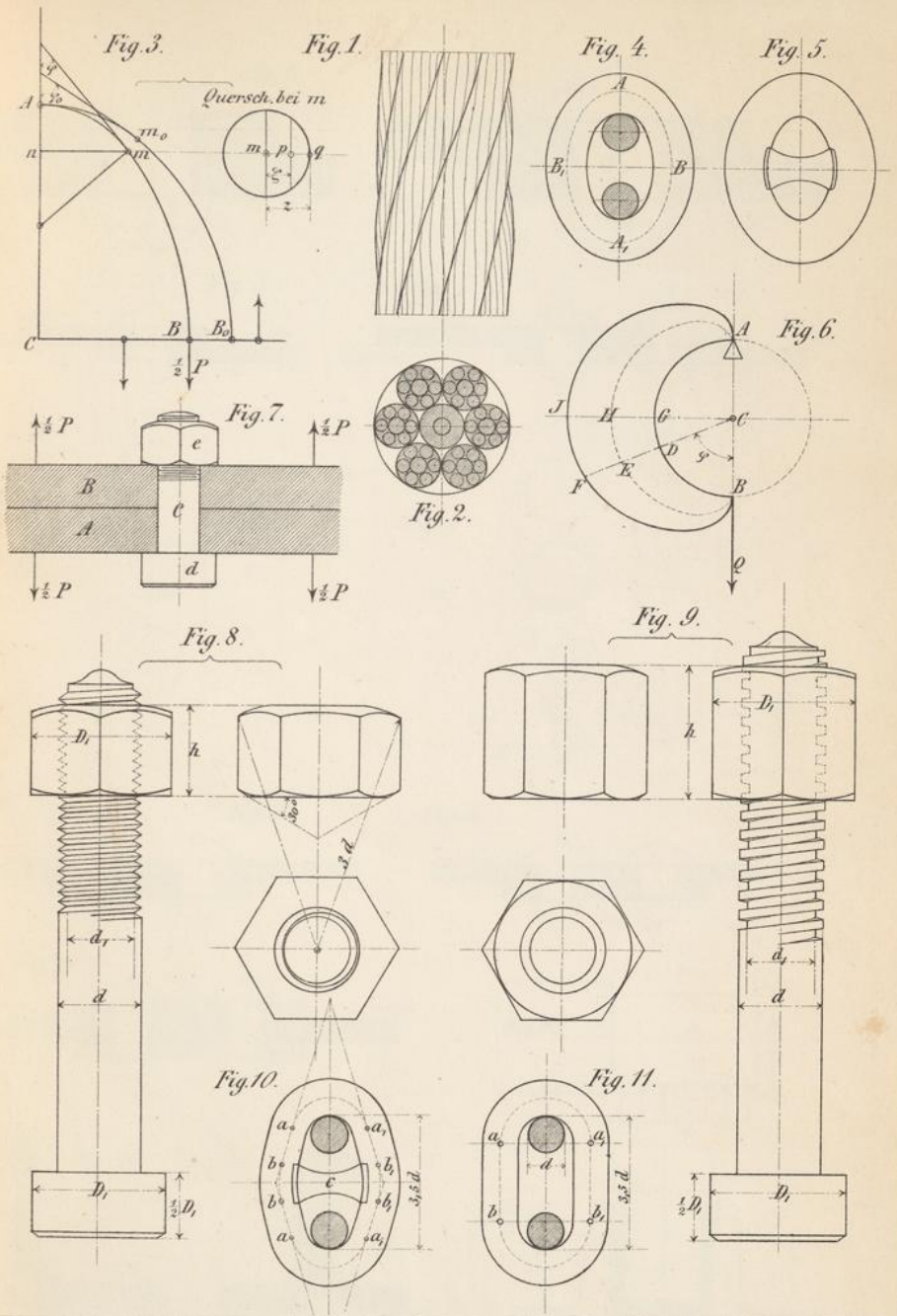



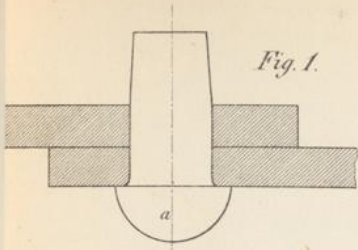

Fig. 1.

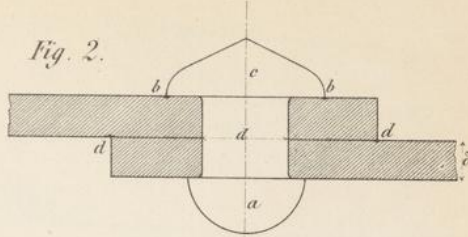

Fig. 2.

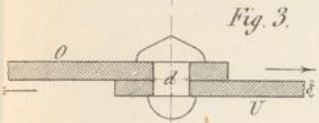

Fig. 3.

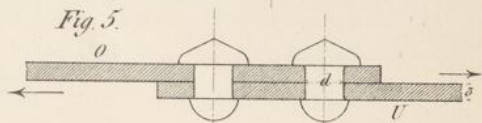

Fig. 5.

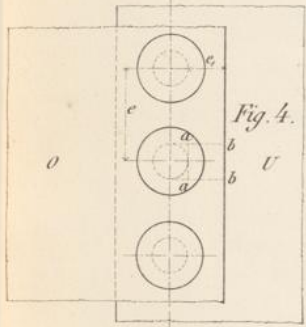

Fig. 4.

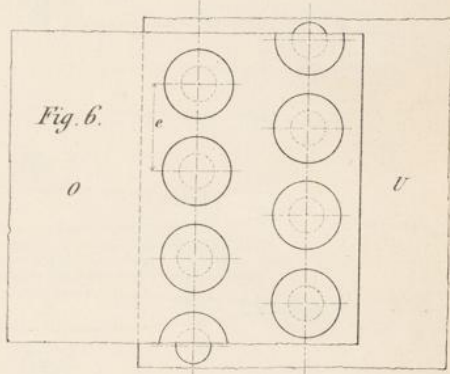

Fig. 6.

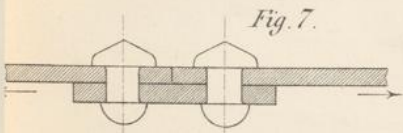

Fig. 7.

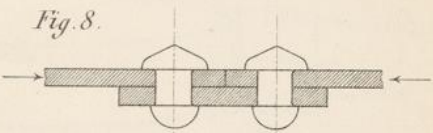

Fig. 8.

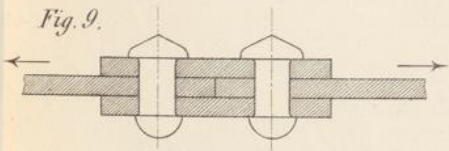

Fig. 9.

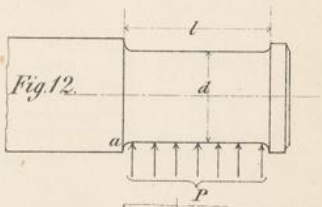

Fig. 12.

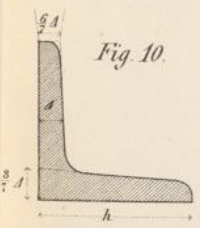

Fig. 10.

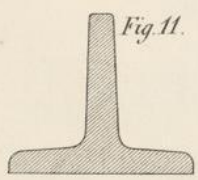

Fig. 11.

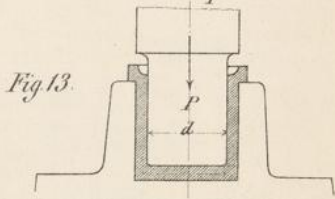

Fig. 13.



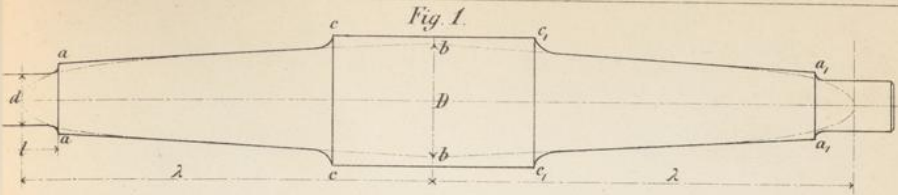

Fig. 1.

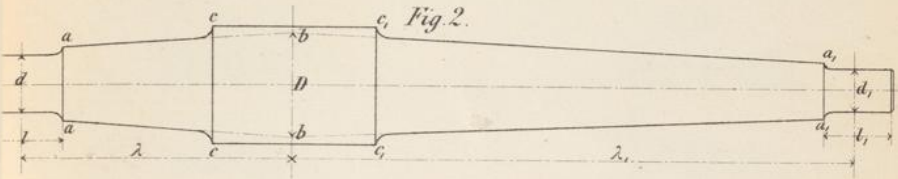

Fig. 2.

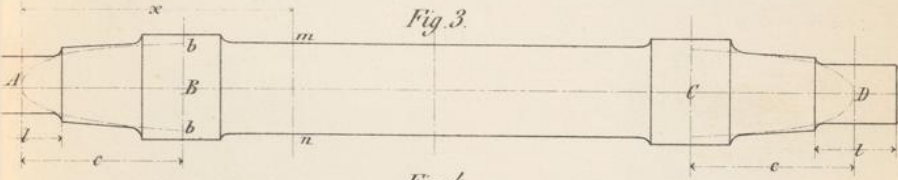

Fig. 3.

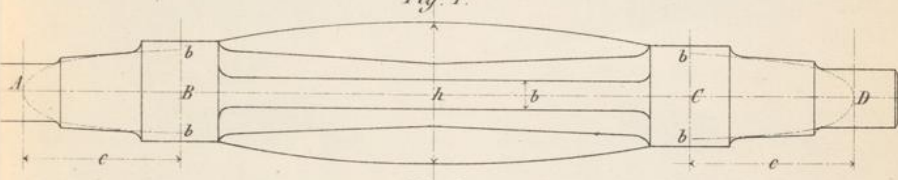

Fig. 4.

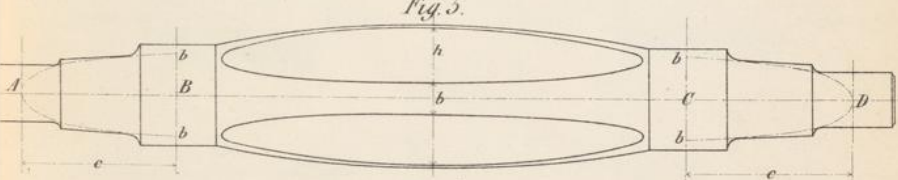

Fig. 5.



Fig. 6.

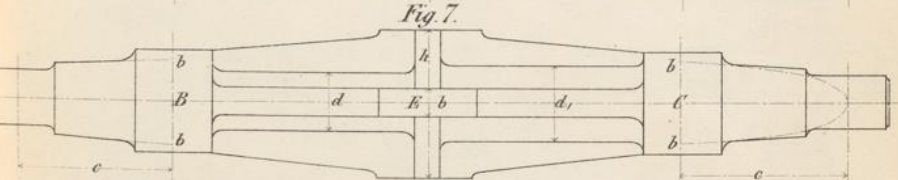
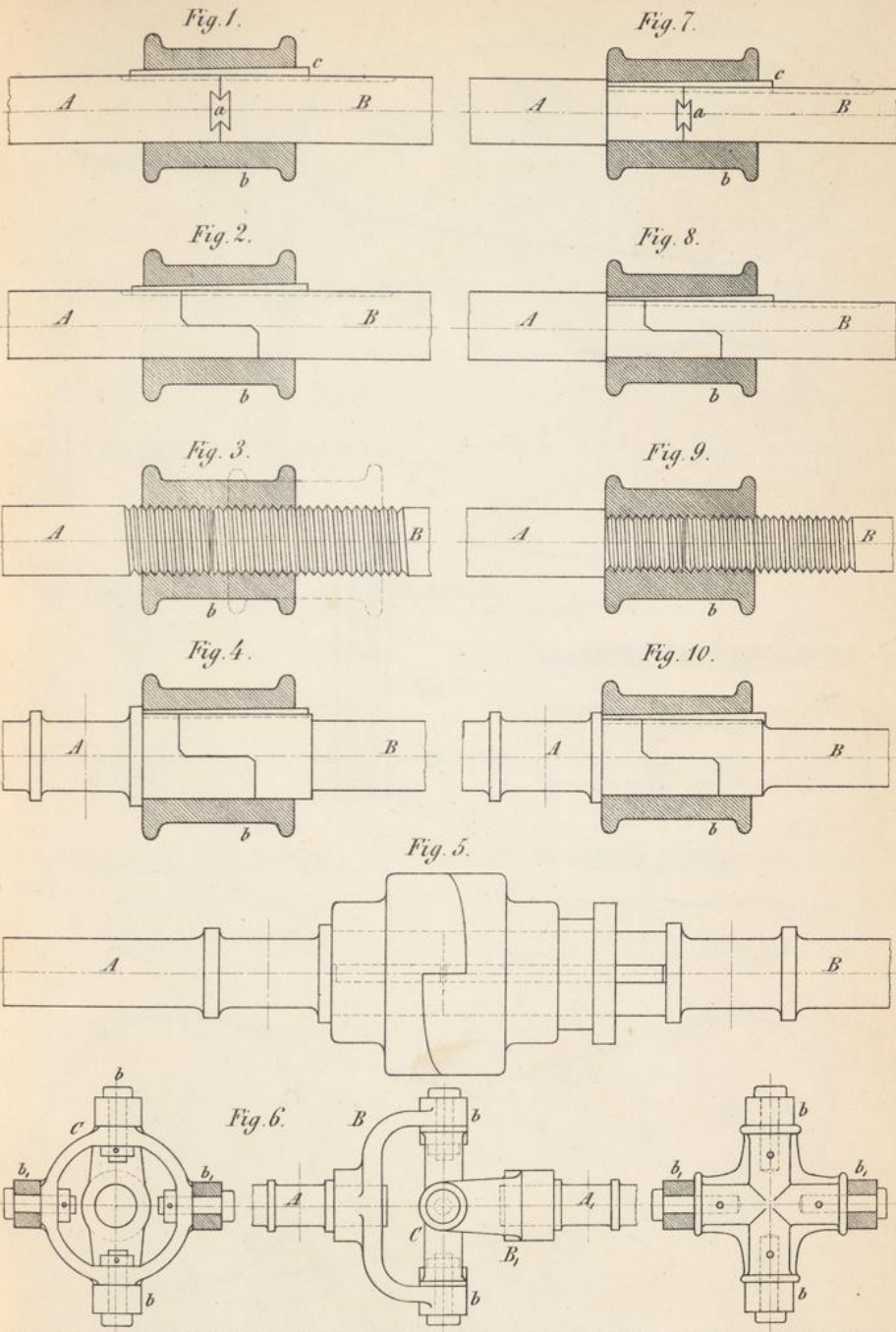

Fig. 7.

Carlruhe, Lith. Anst. v. L. Geisendorfer







Lith. Anst. v. h. Geisendörfer, Carlsruhe



Fig. 1.

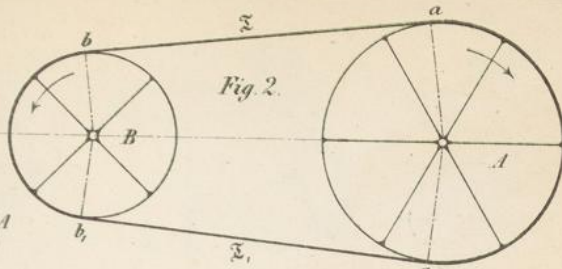
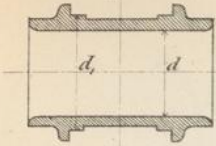

Fig. 2.

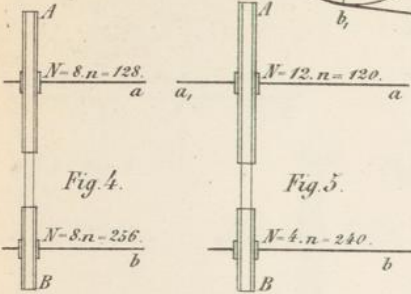

Fig. 4.

Fig. 5.

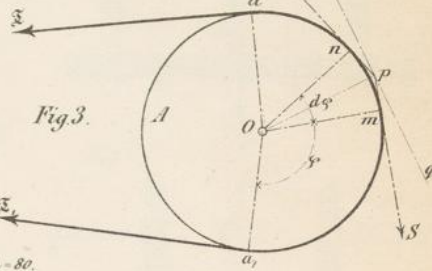

Fig. 3.

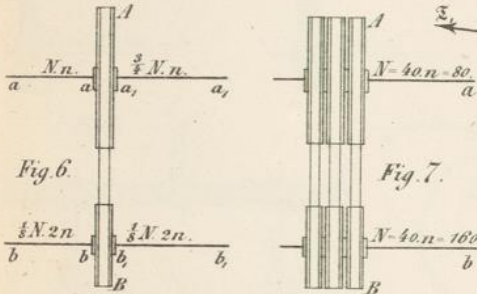

Fig. 6.

Fig. 7.

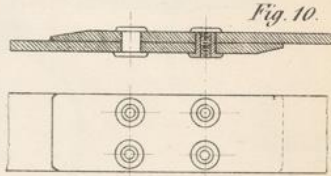

Fig. 10.

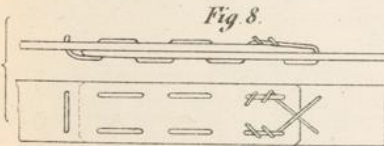

Fig. 8.

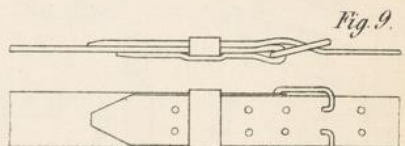

Fig. 9.

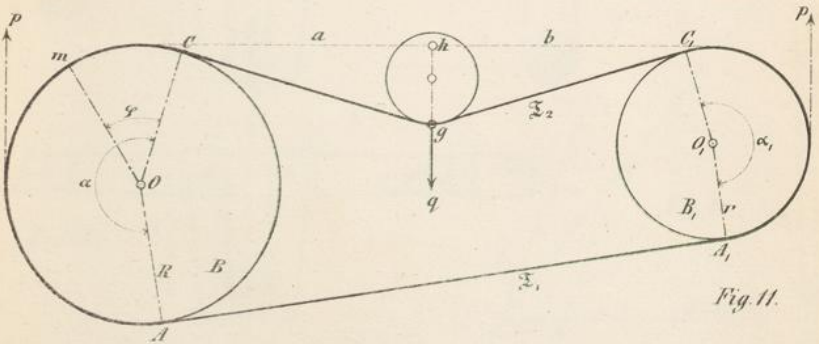
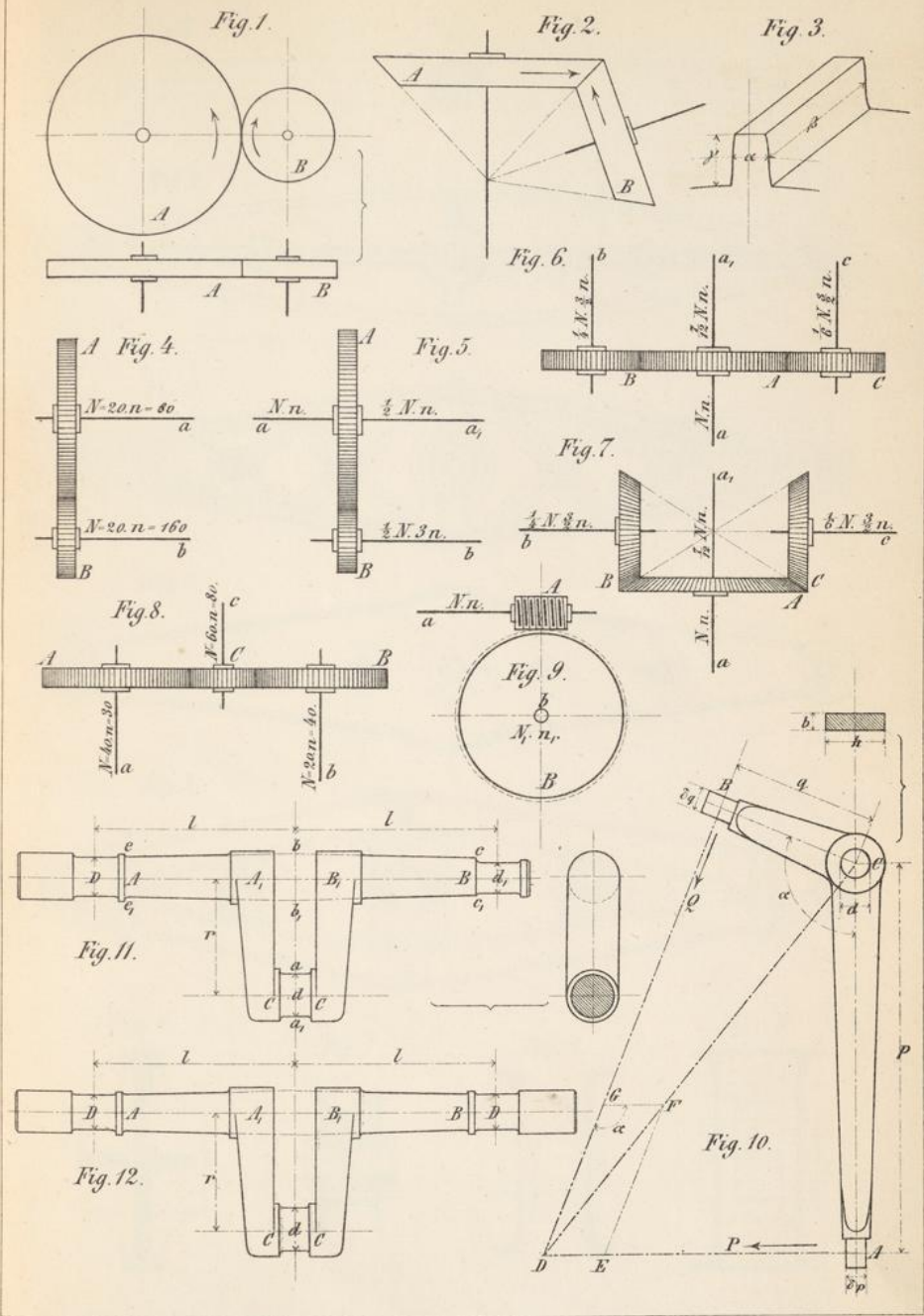

Fig. 11.







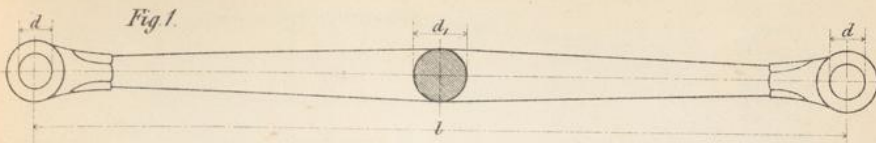

Fig. 1.

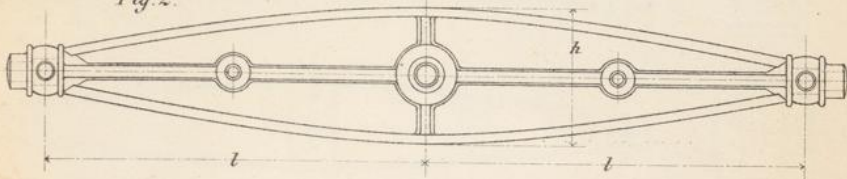

Fig. 2.

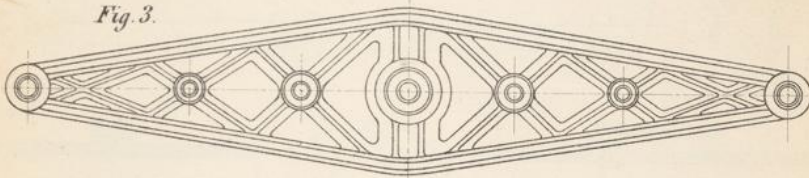

Fig. 3.

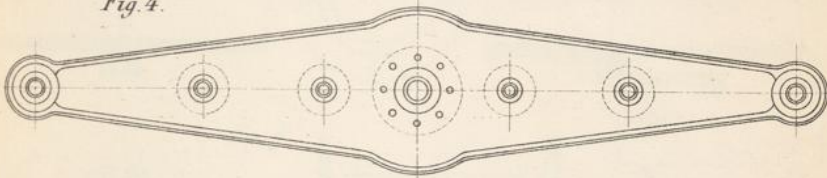

Fig. 4.

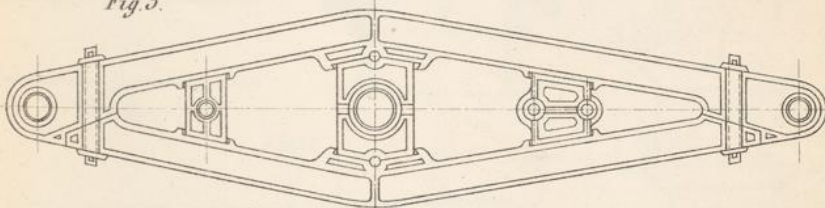

Fig. 6.

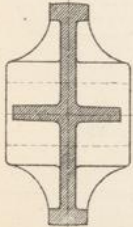

Fig. 7.

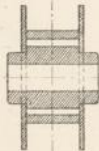

Fig. 8.

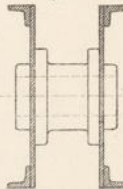
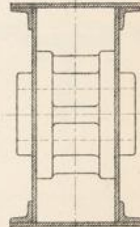

Fig. 9.



Lith. Anst. v. L. Geisendorfer, Carlsruhe.



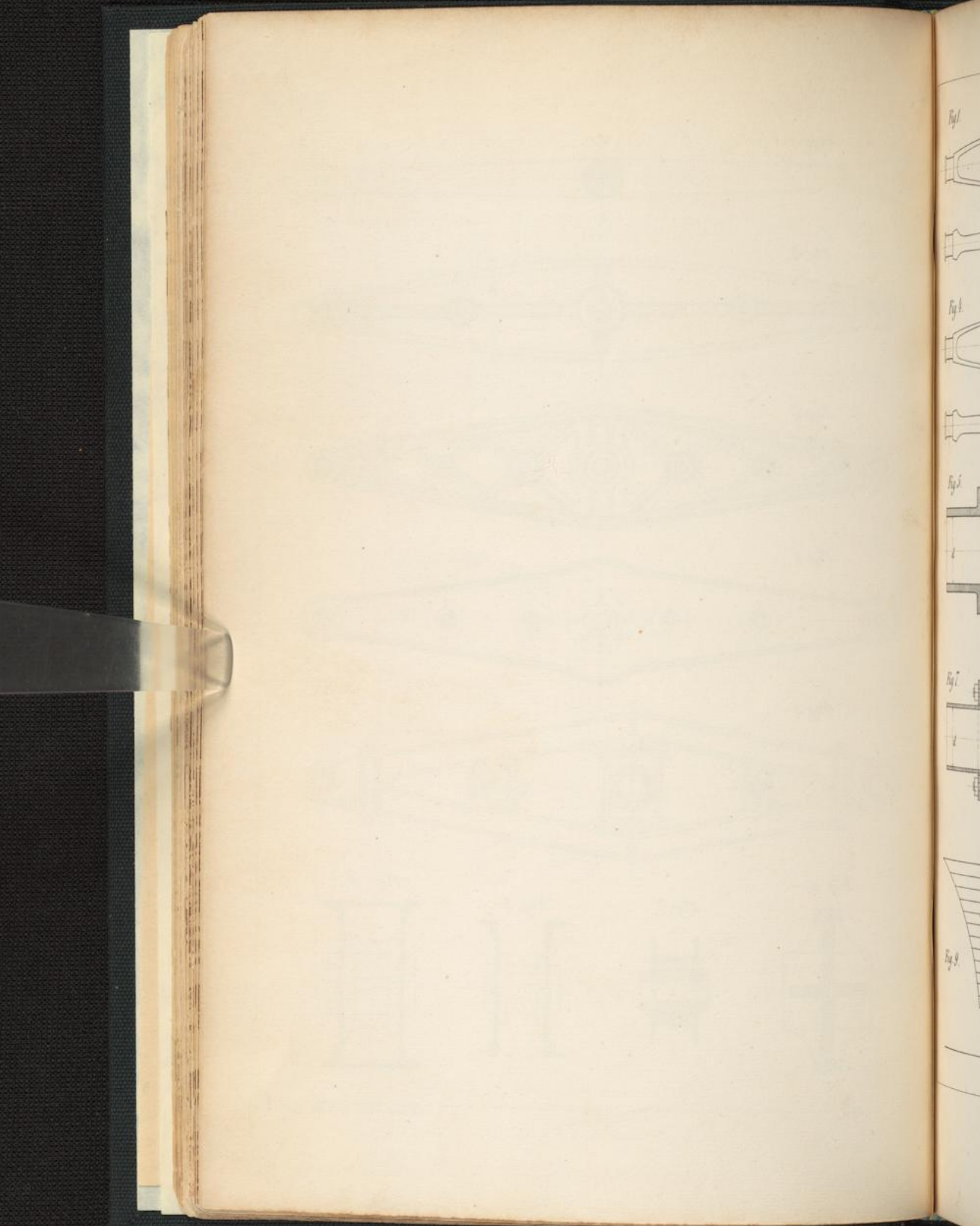

Fig. 1

Fig. 2

Fig. 3

Fig. 4

Fig. 5

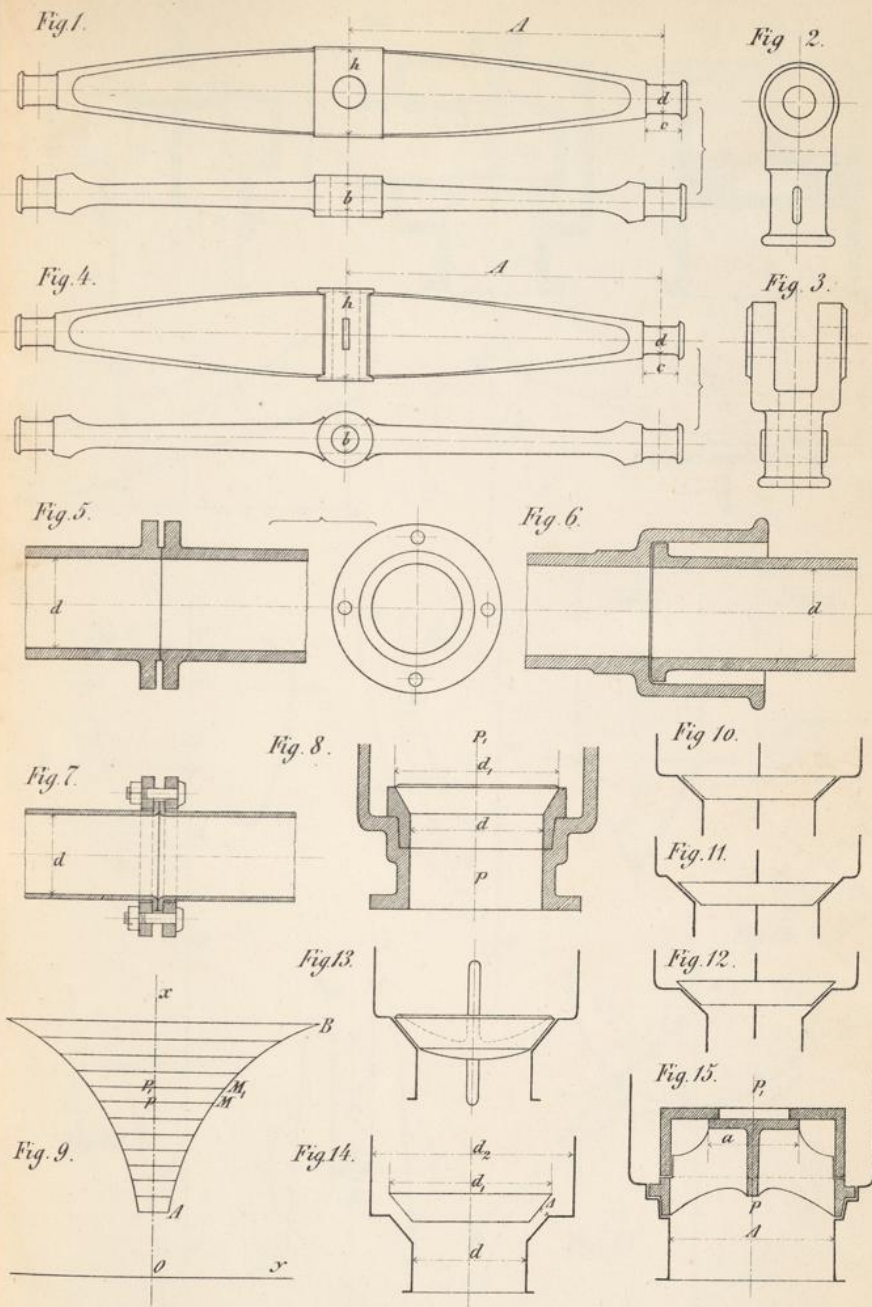

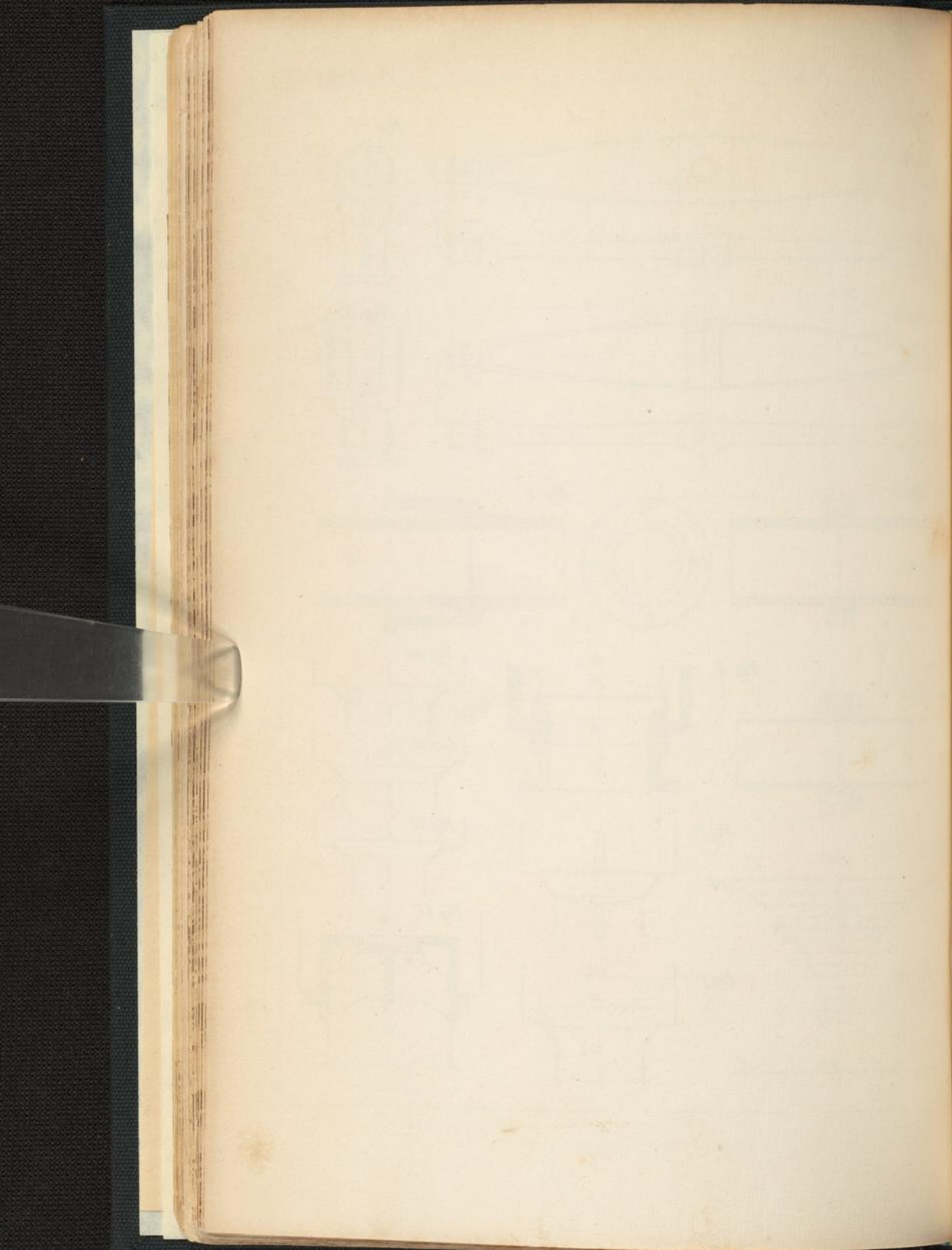

Fig 1



Fig 2

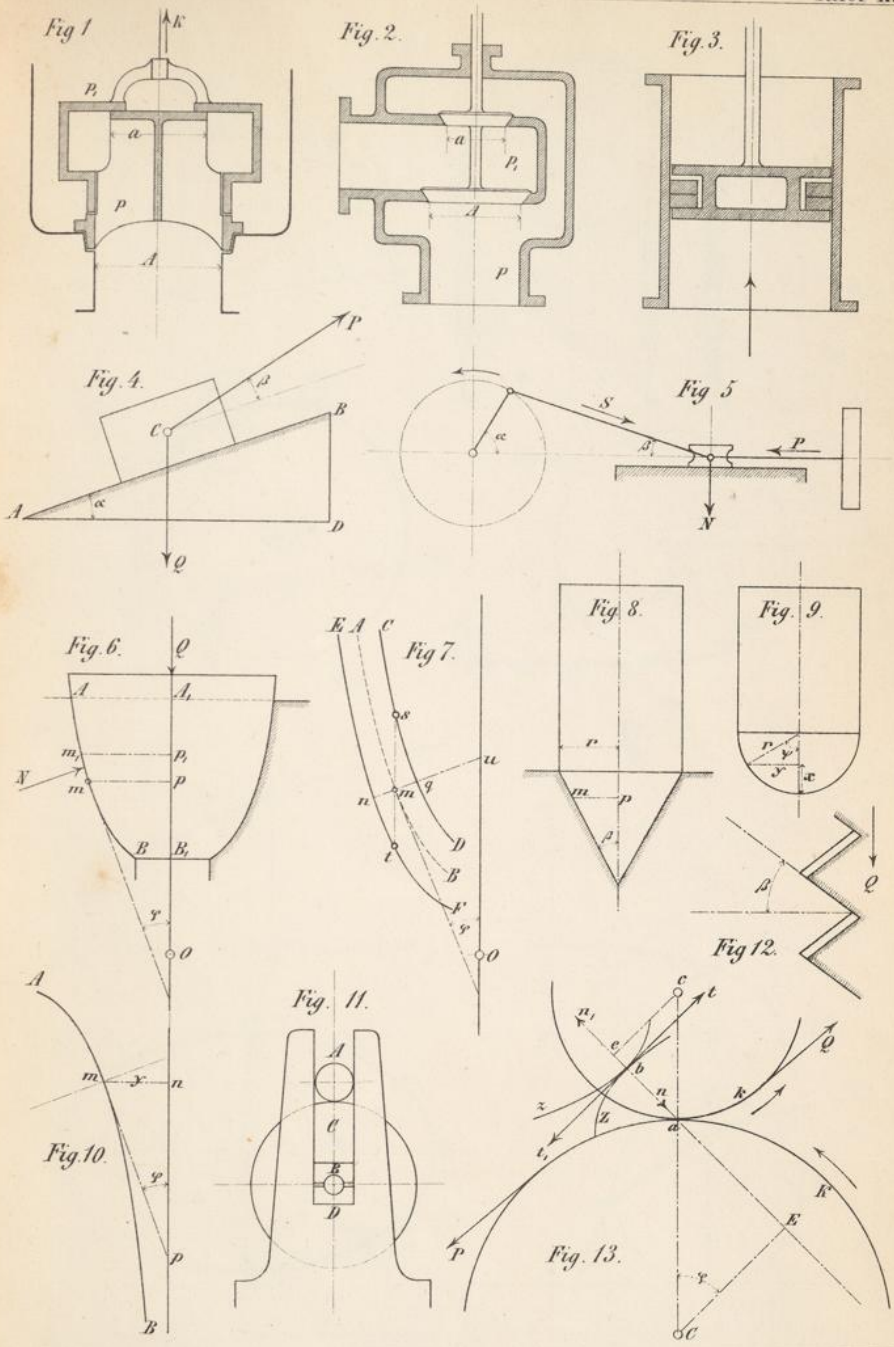

Fig 6



Fig 10





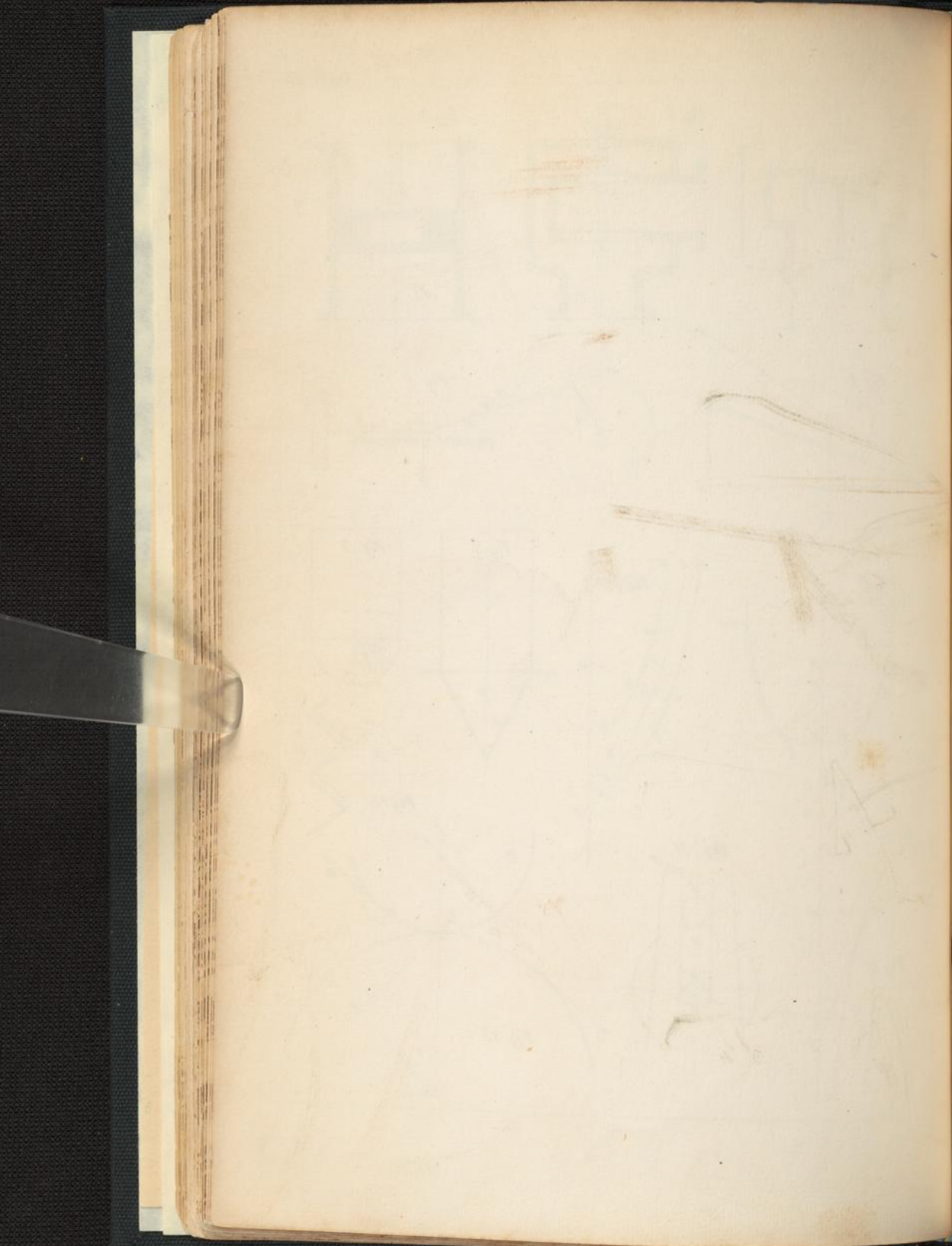

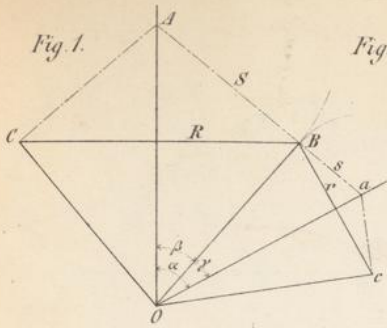

Fig. 2.

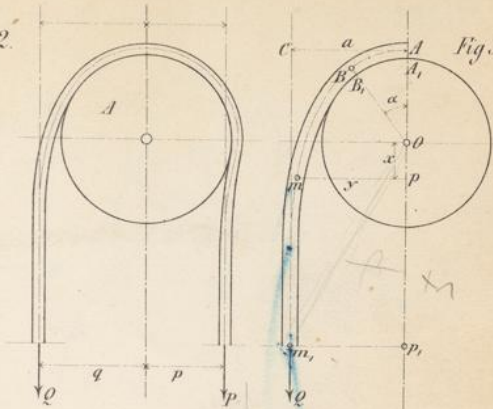

Fig. 3

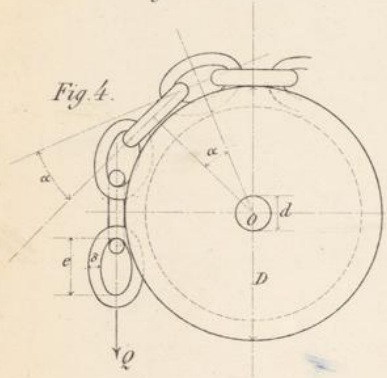

Fig. 4.

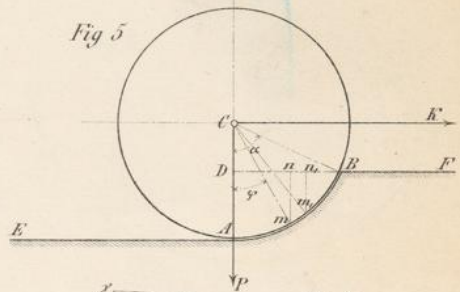

Fig. 5

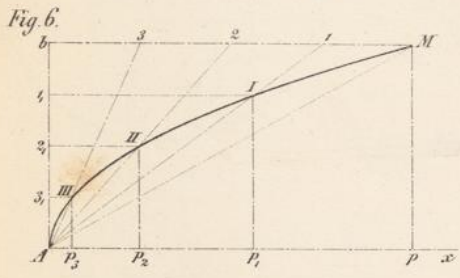

Fig. 6.

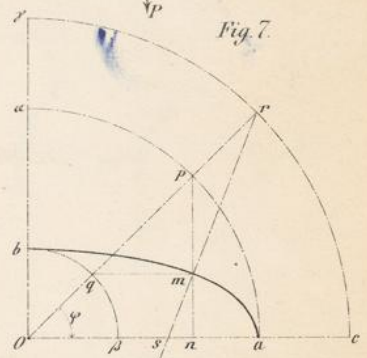

Fig. 7.

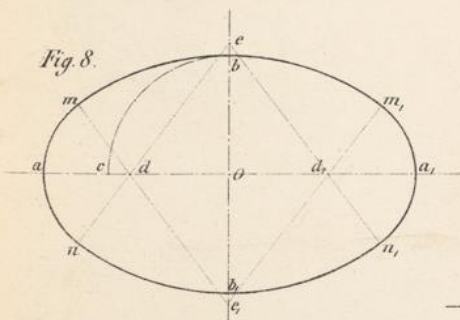

Fig. 8.

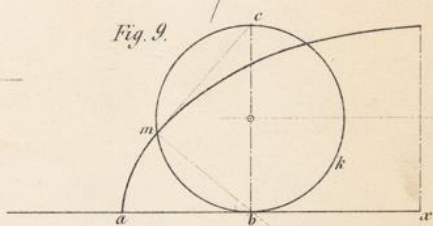
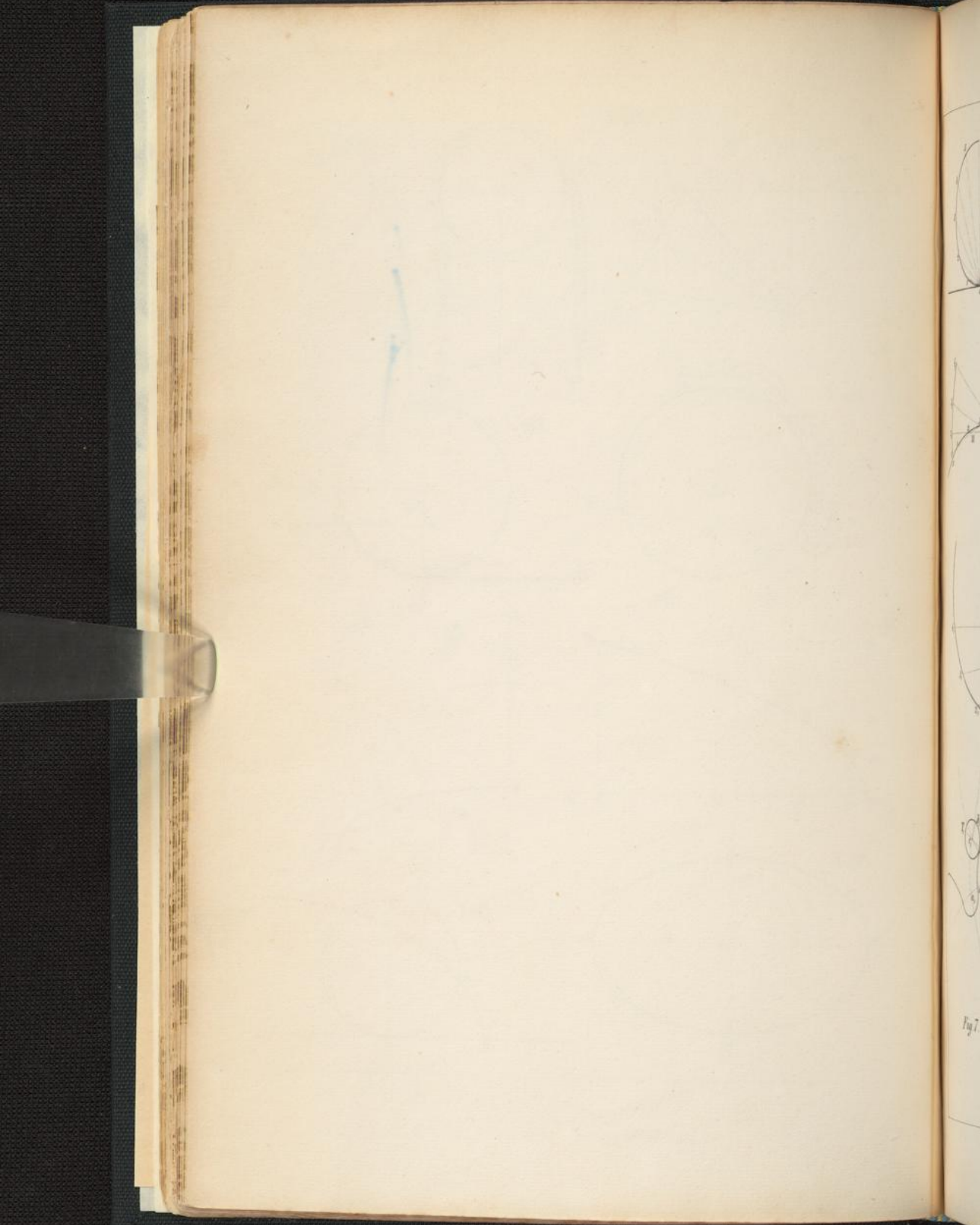
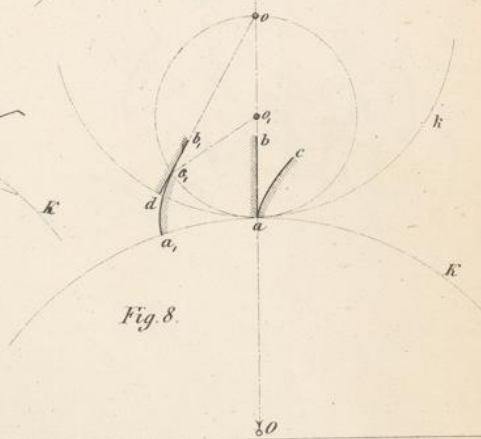
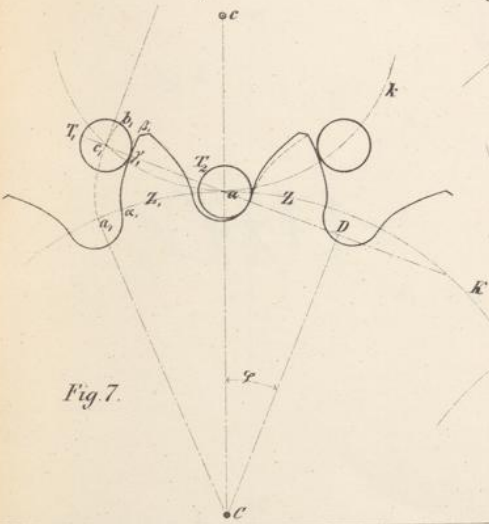
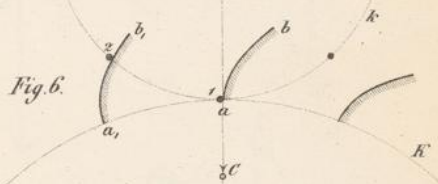
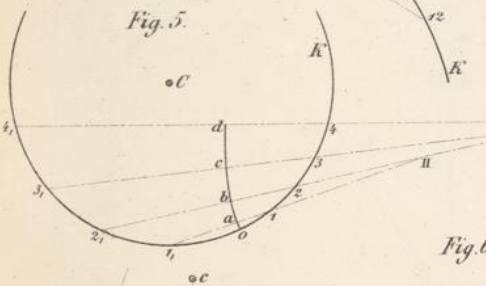
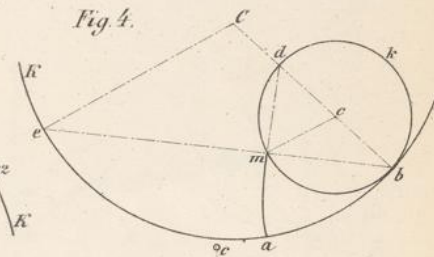
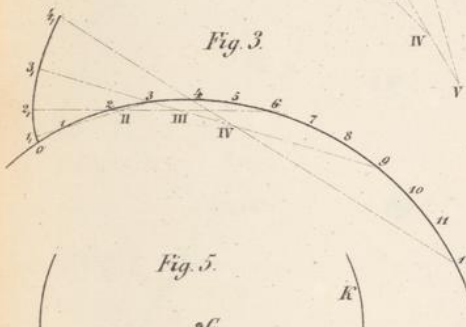
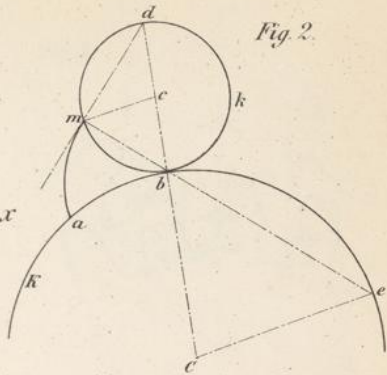
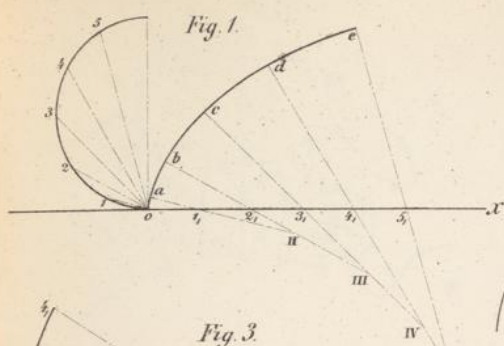
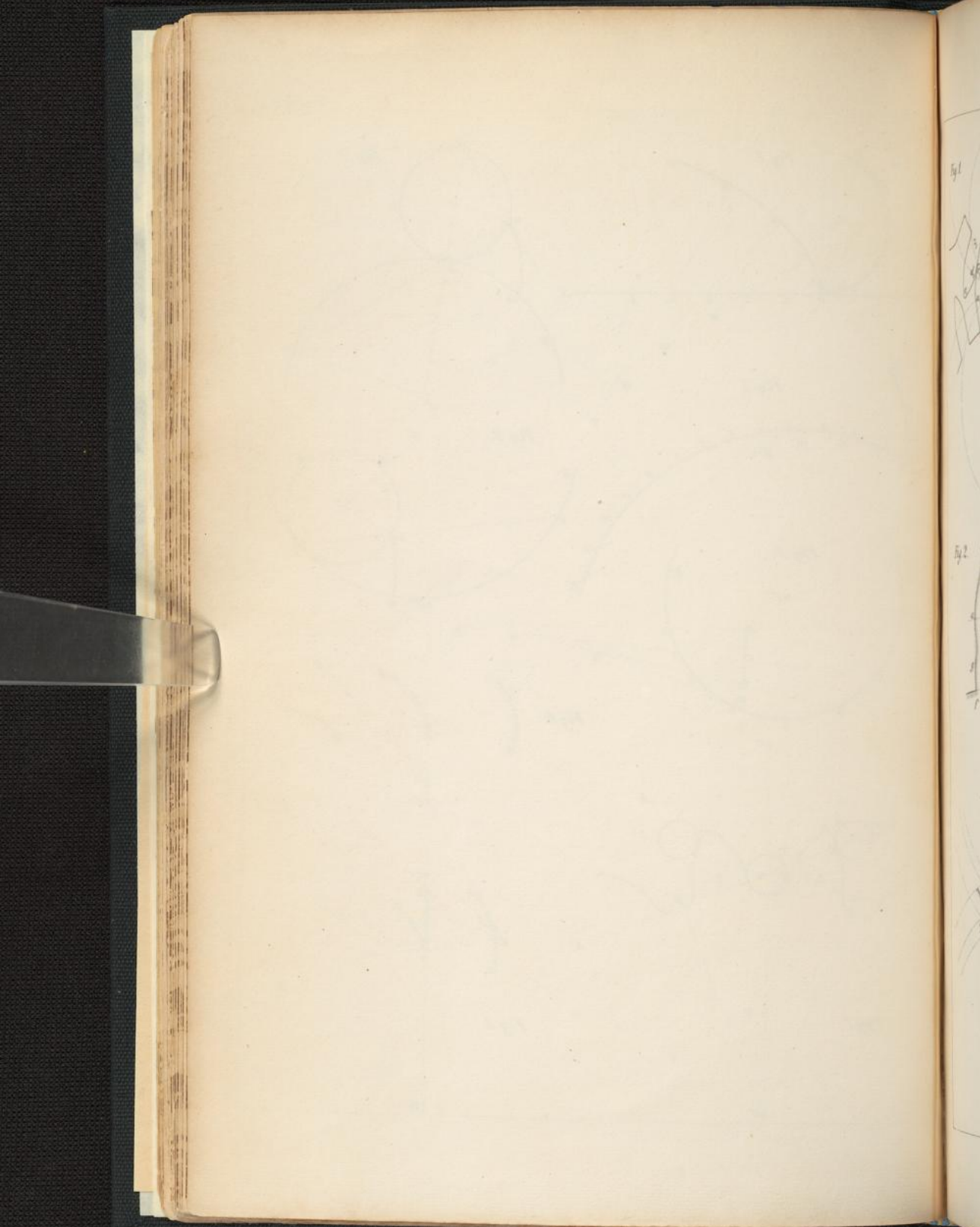

Fig. 9.









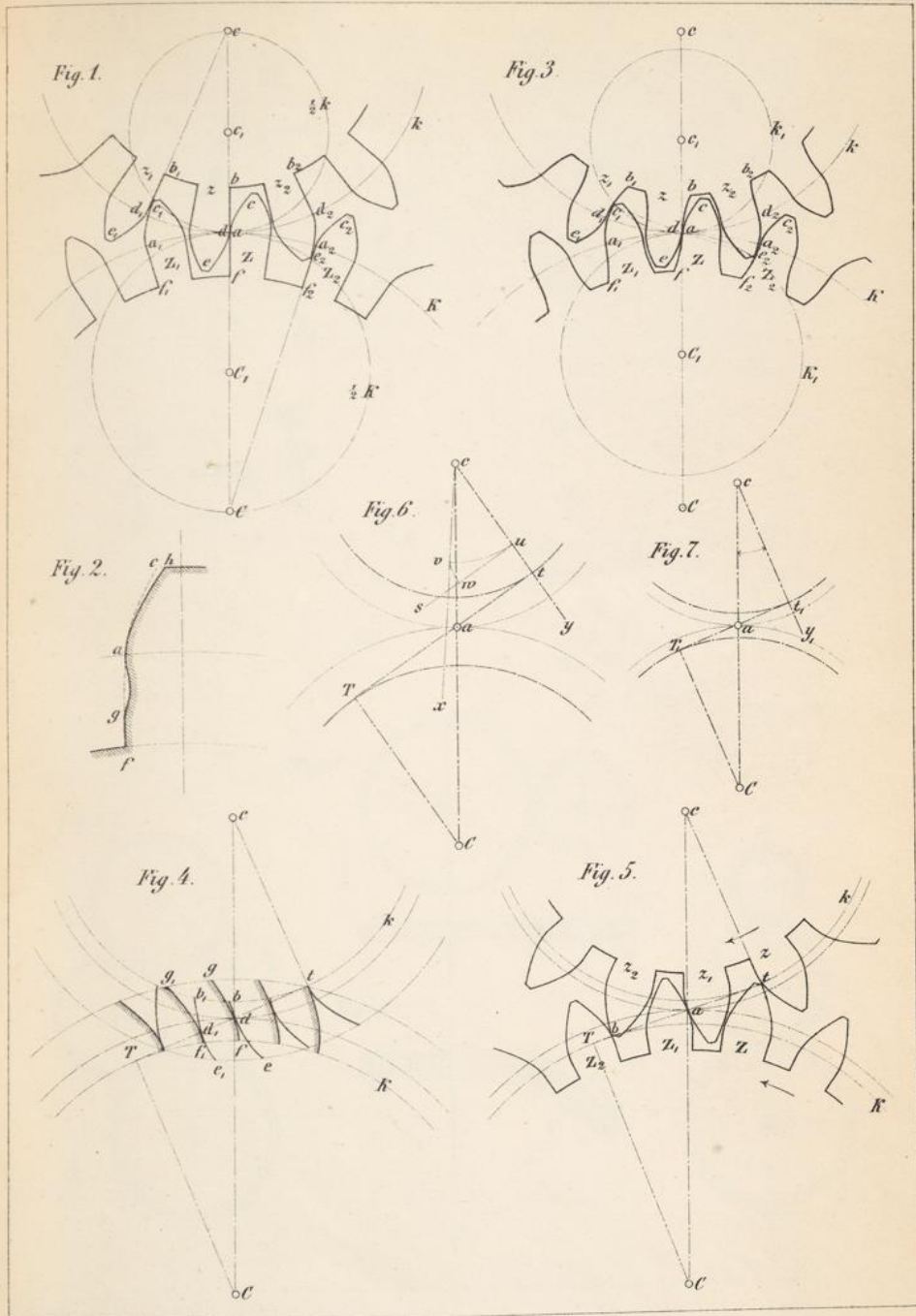

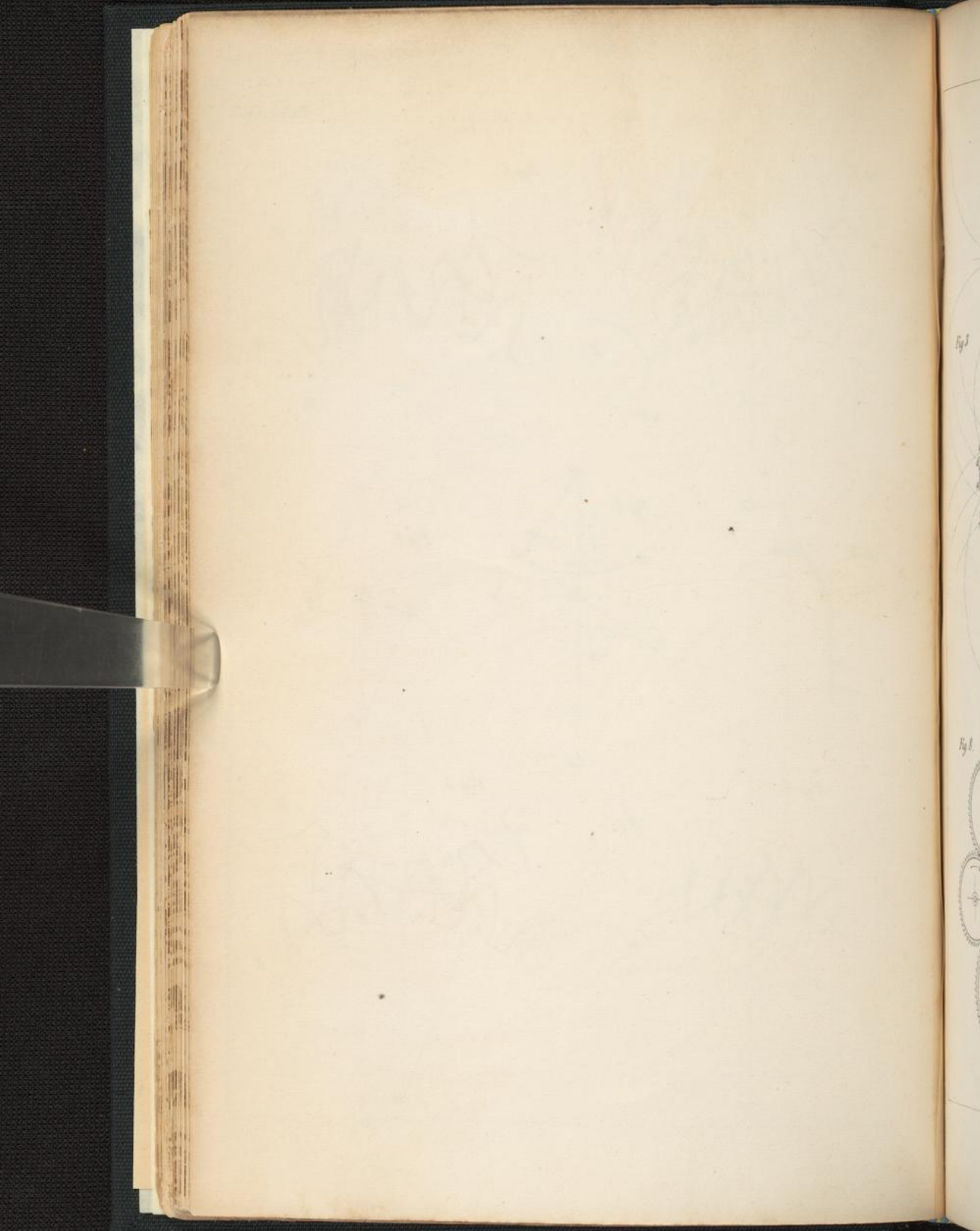

Fig. 1.

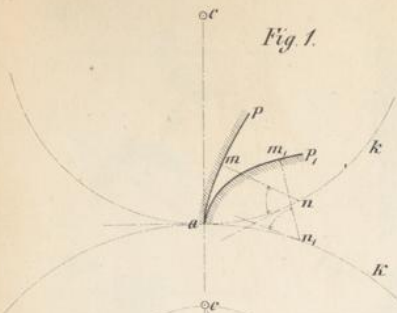

Fig. 2.

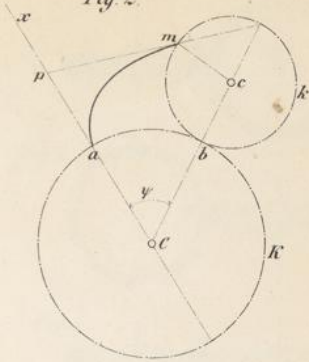

Fig. 3.

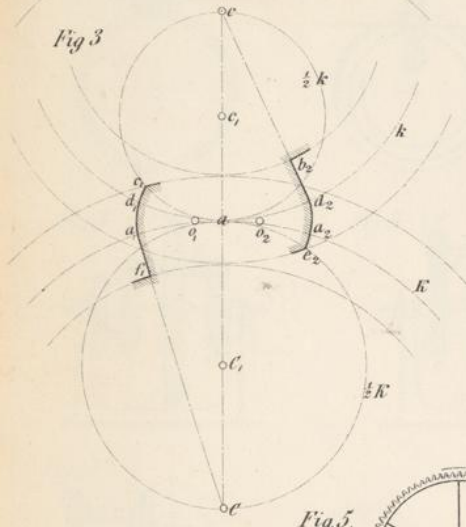

Fig. 4.

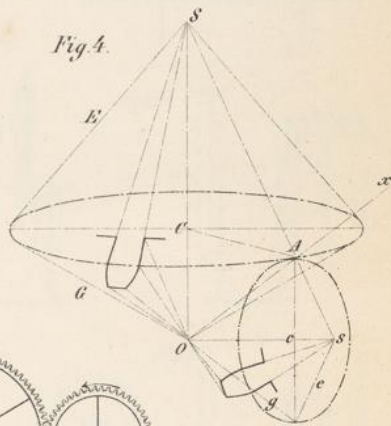

Fig. 5.

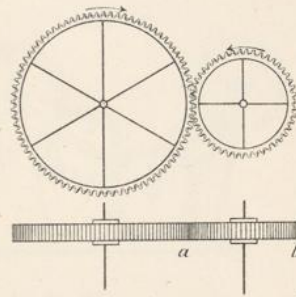

Fig. 8.

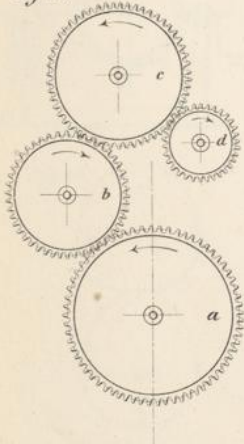

Fig. 6.

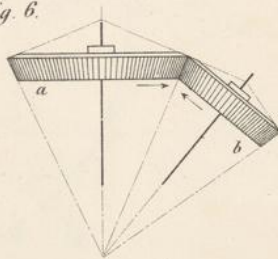
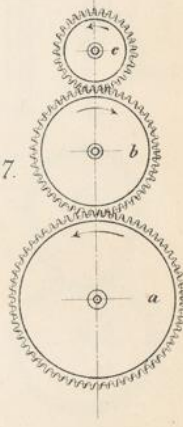

Fig. 7.



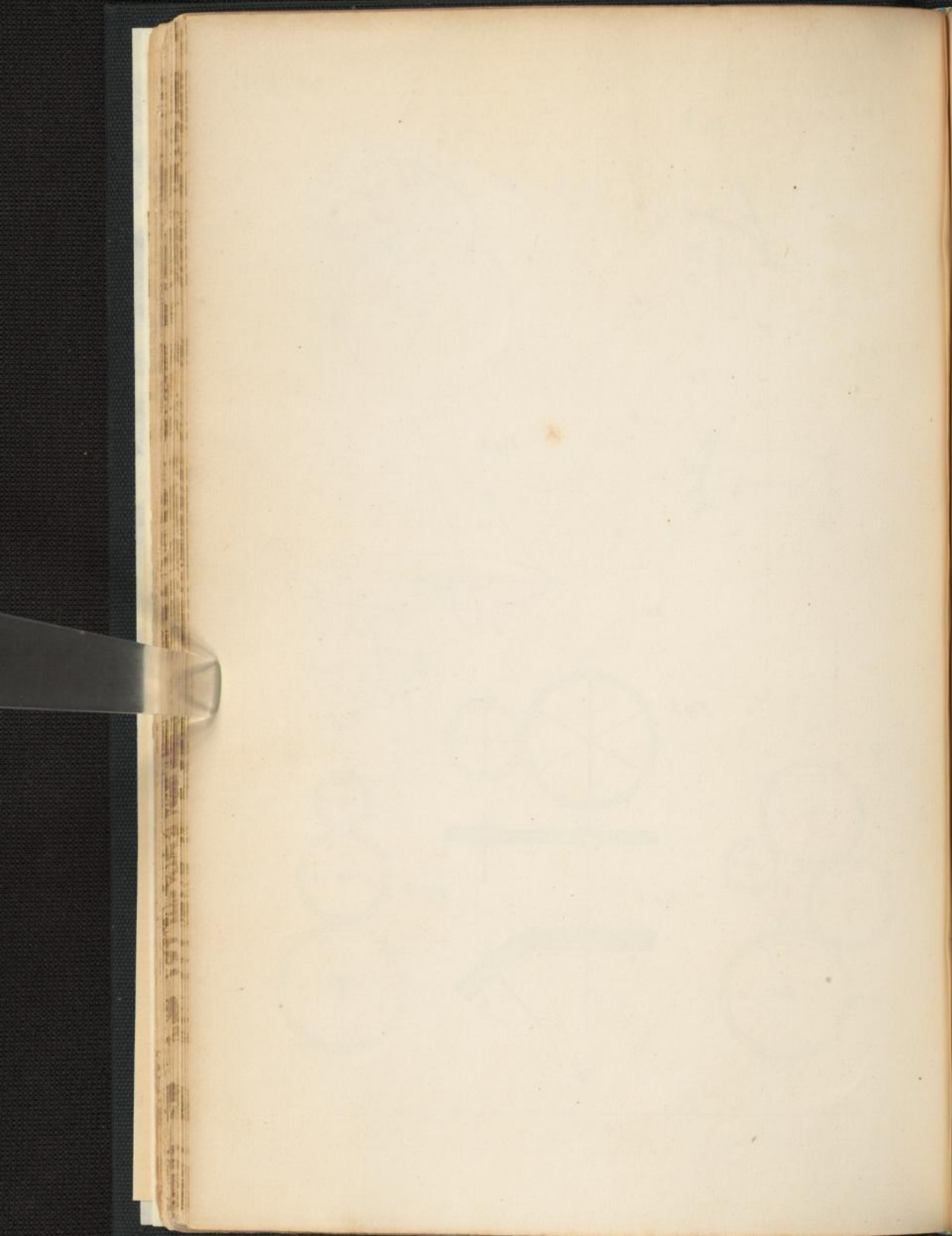

Fig. 1



Fig. 6

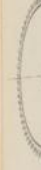

Fig. 7

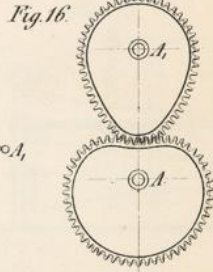
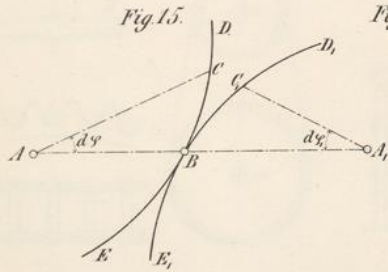
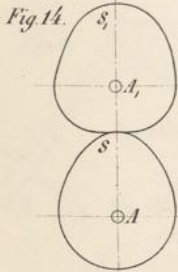
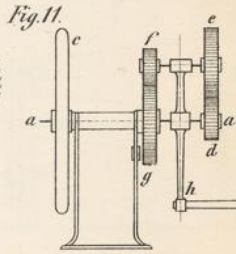
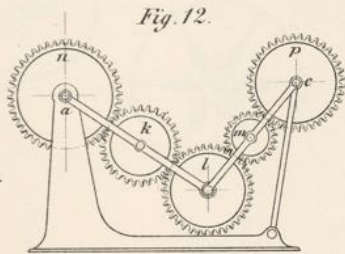
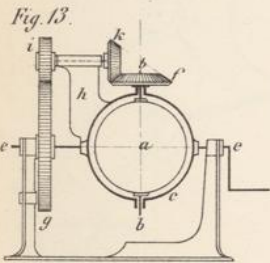
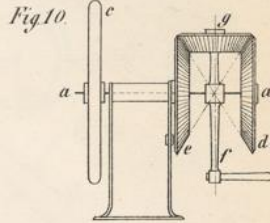
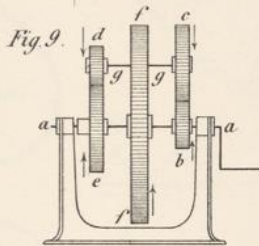
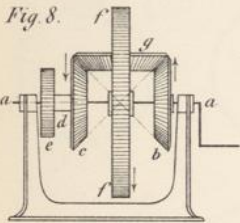
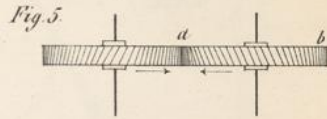
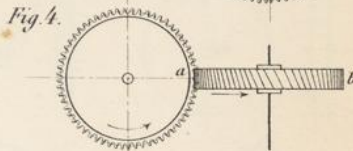
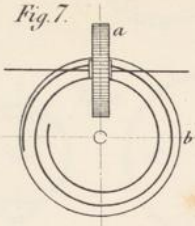
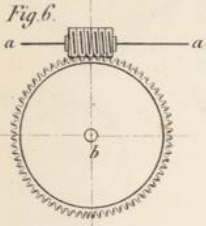
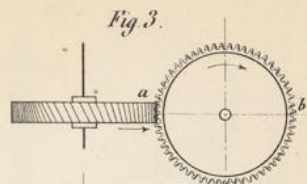
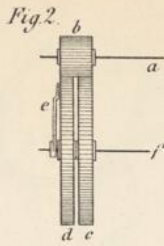
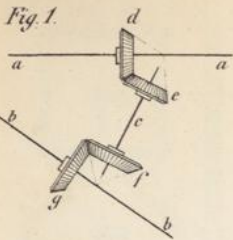

Fig. 11



Fig. 14





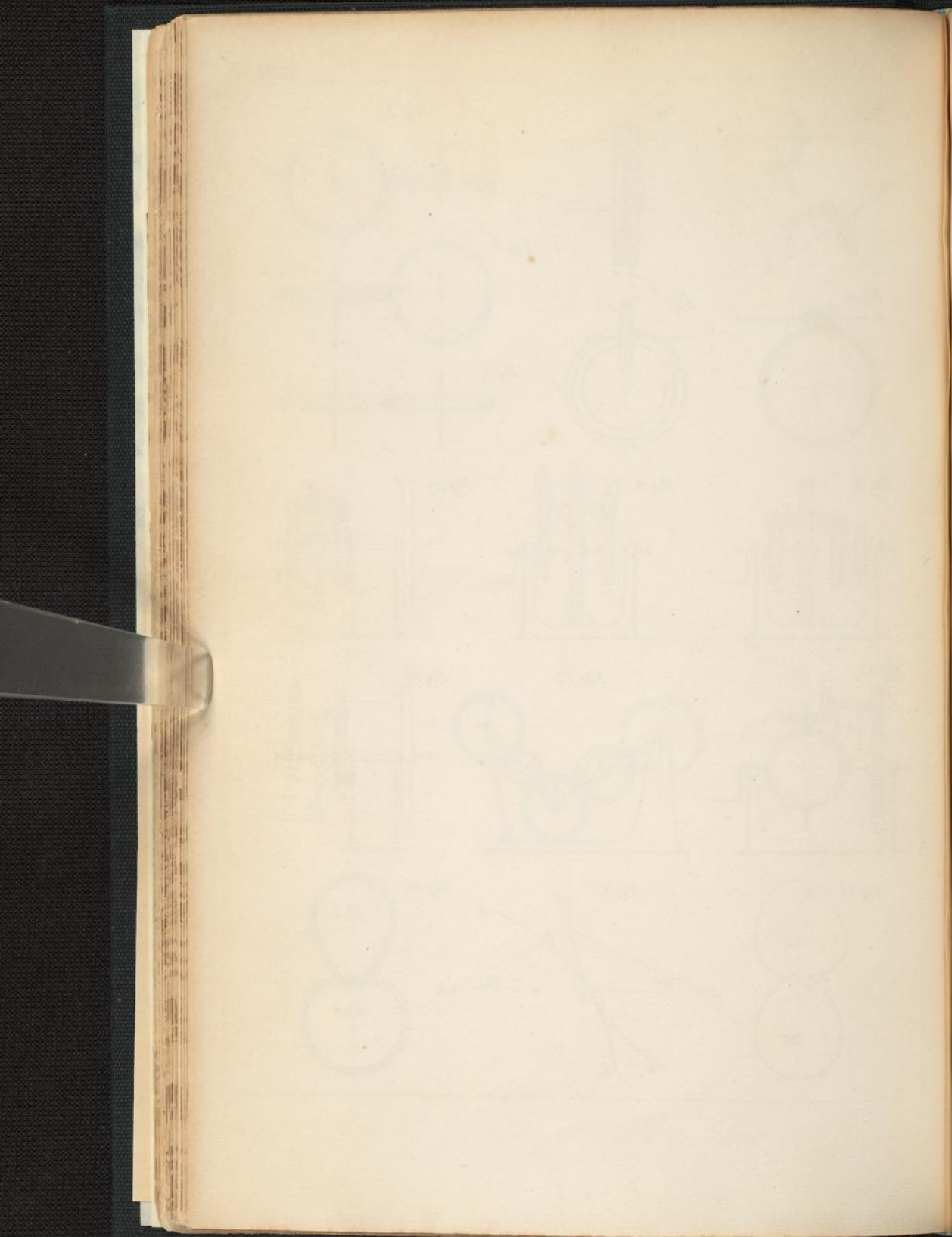

Fig. 1.

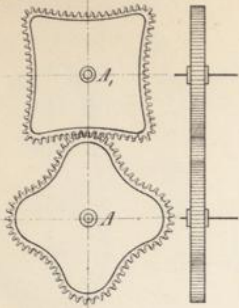

Fig. 2.

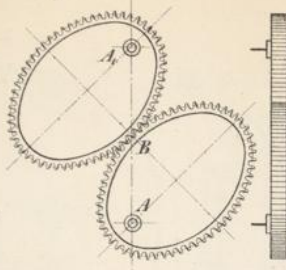

Fig. 3.

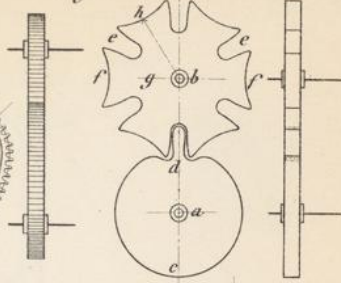

Fig. 4.

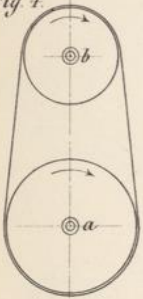

Fig. 5.

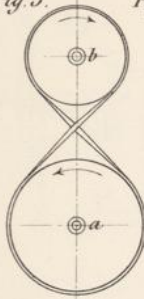

Fig. 6.

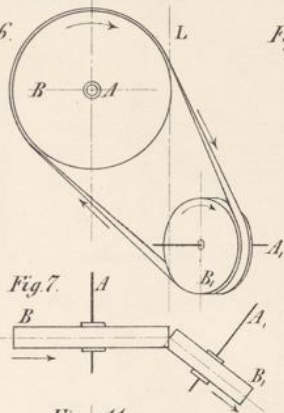

Fig. 10.

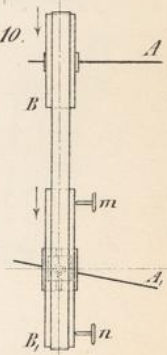

Fig. 8.

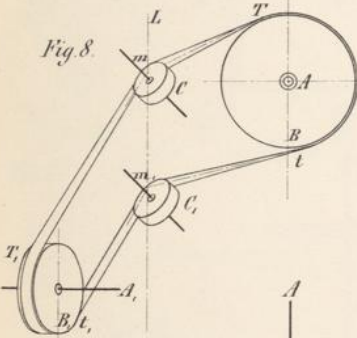

Fig. 11.

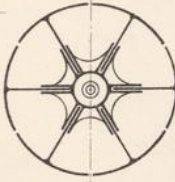

Fig. 12.

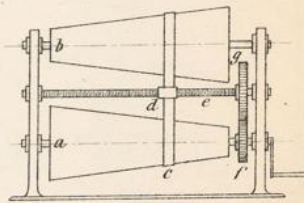

Fig. 9.

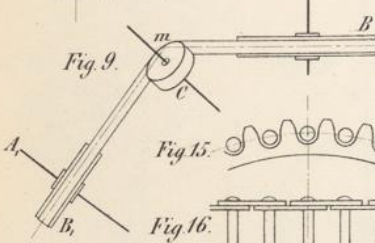

Fig. 14.

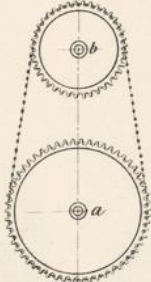

Fig. 13.

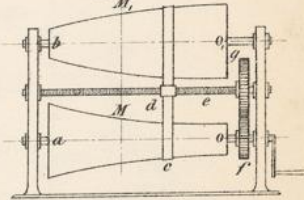
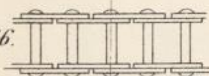

Fig. 15.



Fig. 16.



Lith. v. L. Geisenhöfer, Karlsruhe.



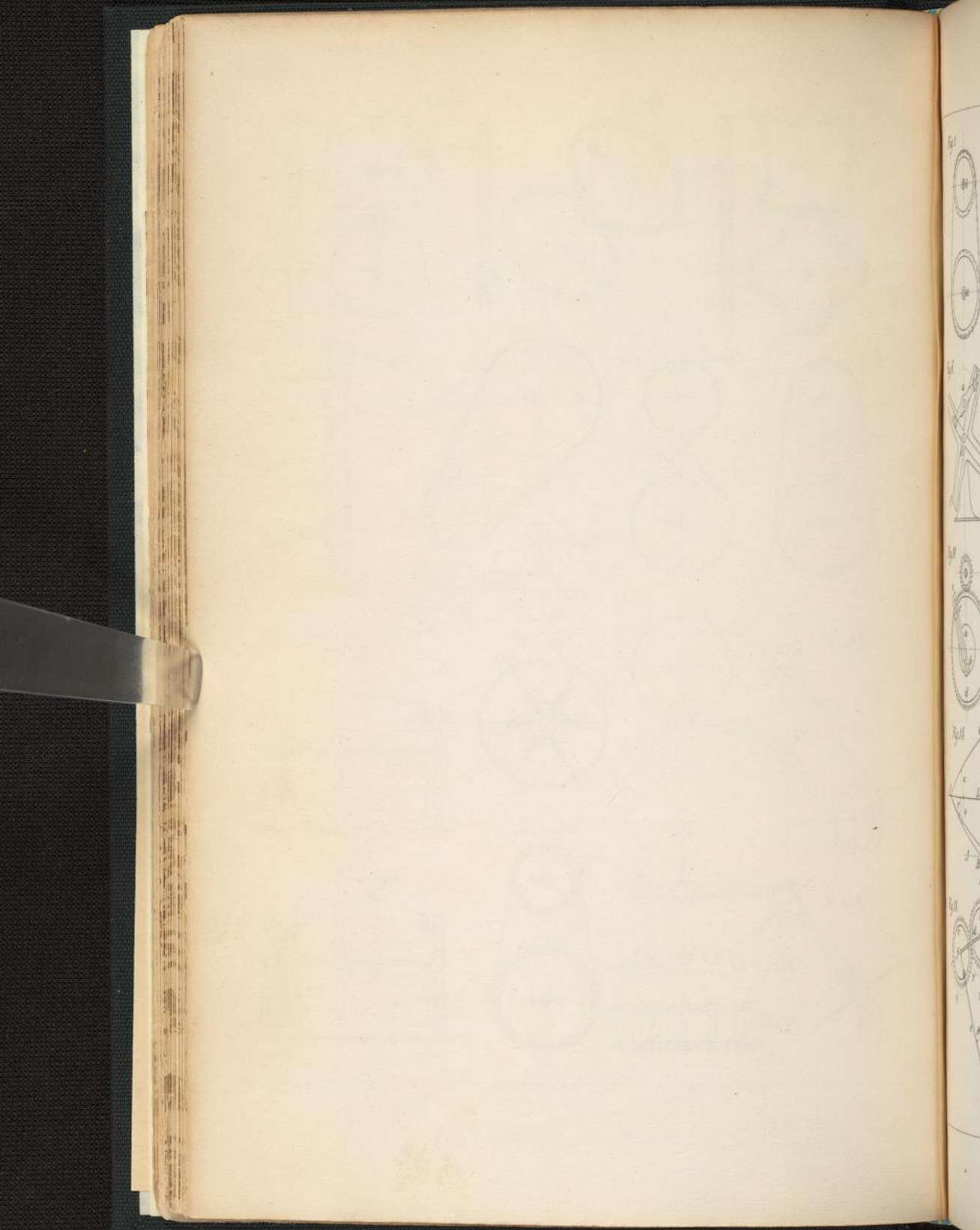

Fig. 1.

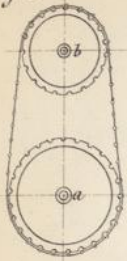

Fig. 2.



Fig. 3.

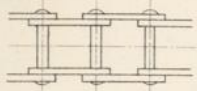

Fig. 4.

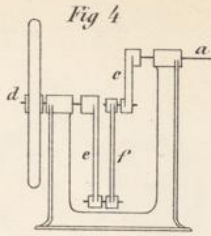

Fig. 5.

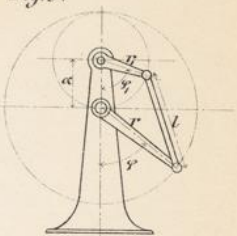

Fig. 6.

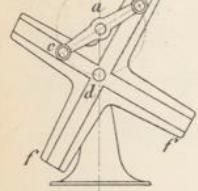

Fig. 7.

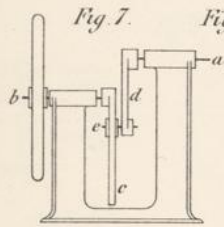

Fig. 8.

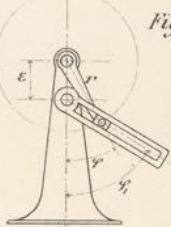

Fig. 9.

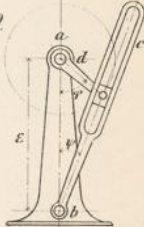

Fig. 10.

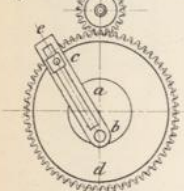

Fig. 11.

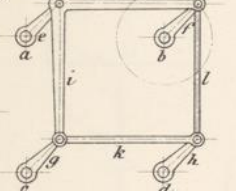

Fig. 12.

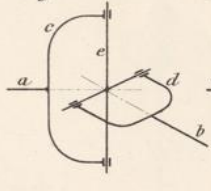

Fig. 13.

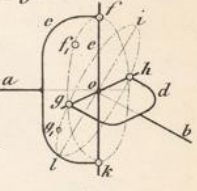

Fig. 14.

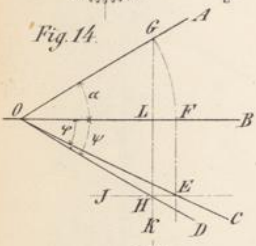

Fig. 15.

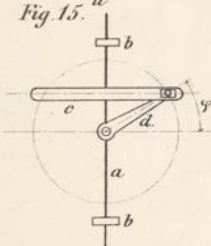

Fig. 16.

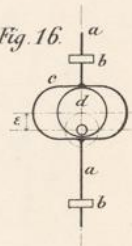

Fig. 17.

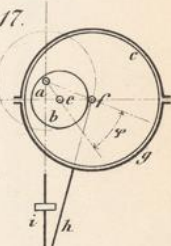

Fig. 18.

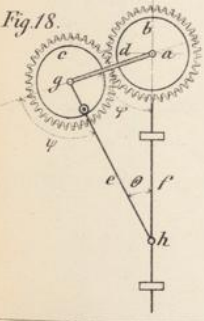

Fig. 19.

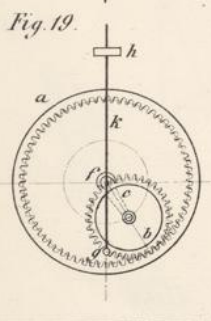
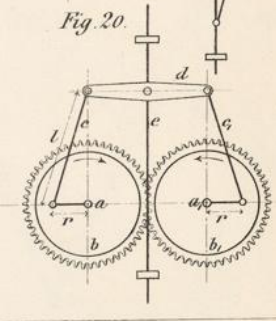
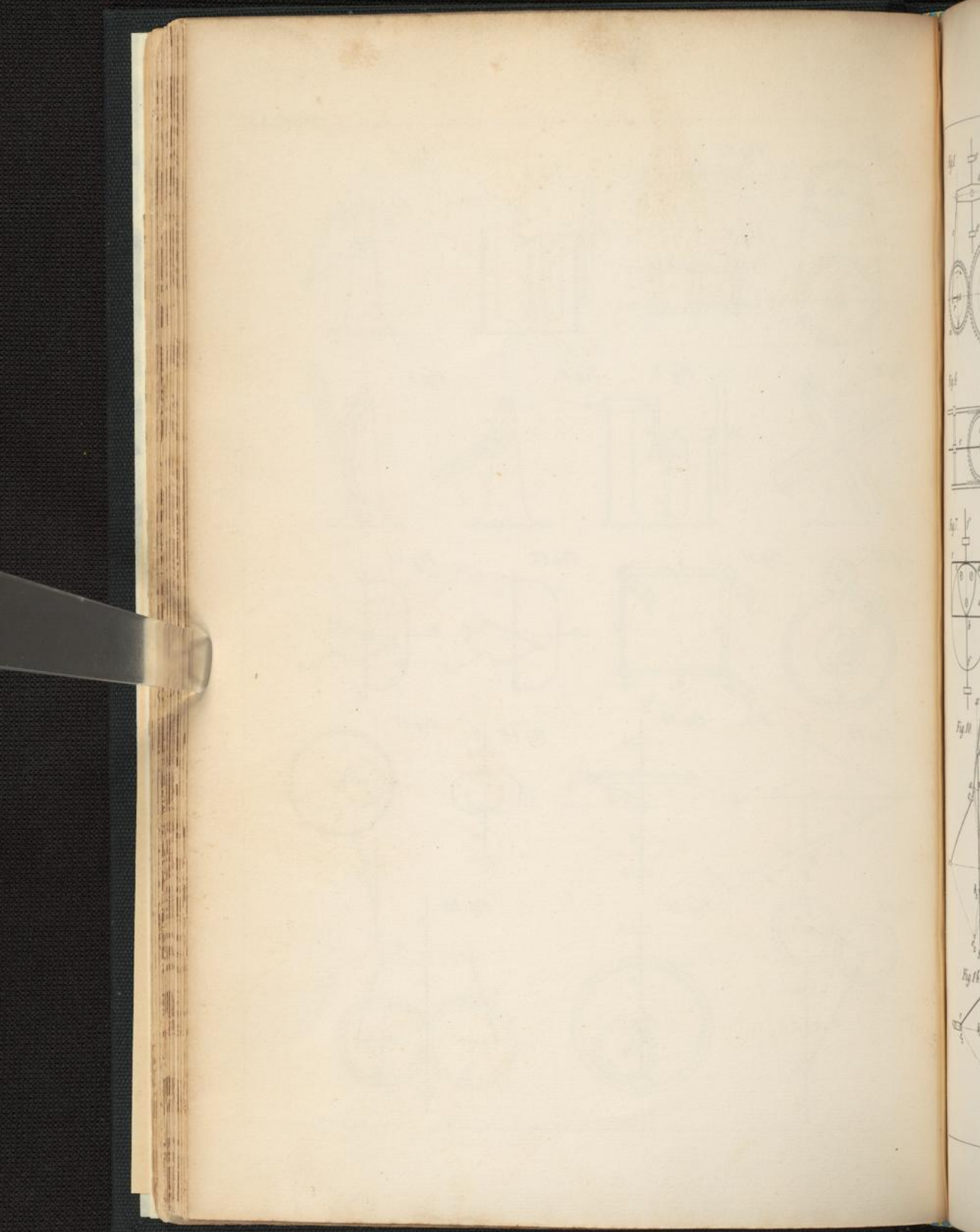

Fig. 20.





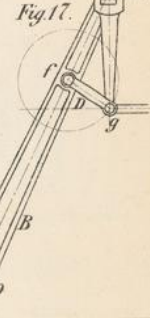
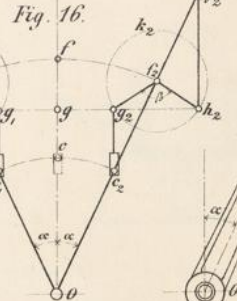
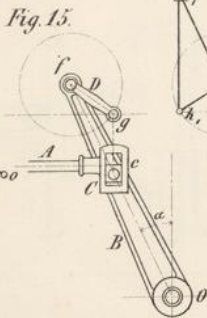
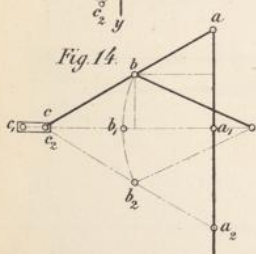
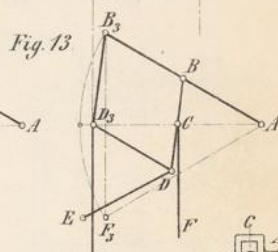
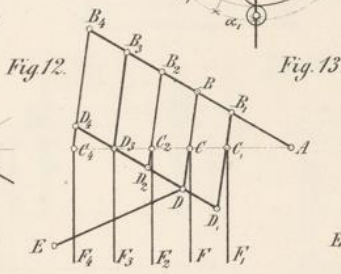
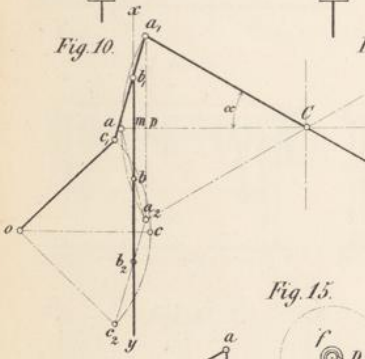
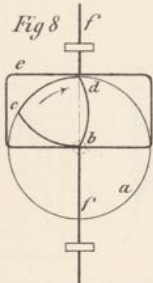
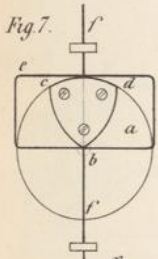
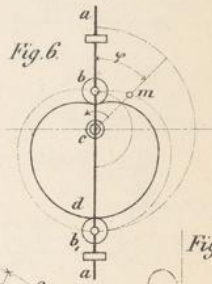
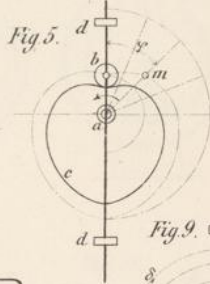
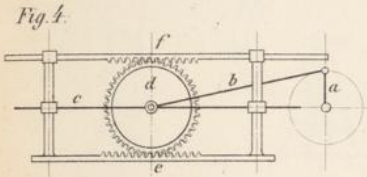
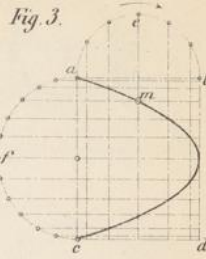
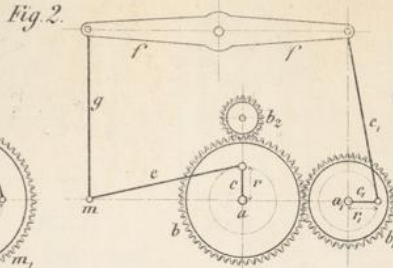
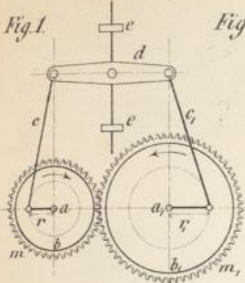



Fig. 1.

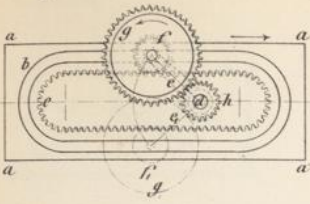

Fig. 2.

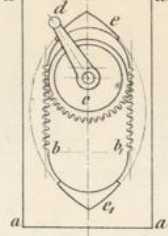

Fig. 3.

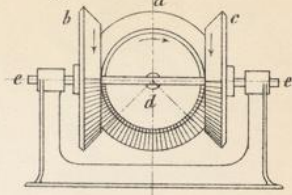

Fig. 4.

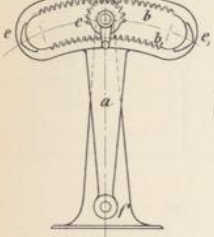

Fig. 5.

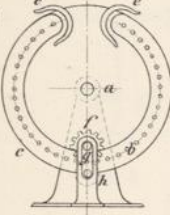

Fig. 6.

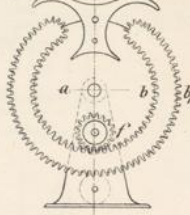

Fig. 7.

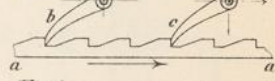

Fig. 8.



Fig. 9.

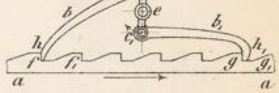

Fig. 10.

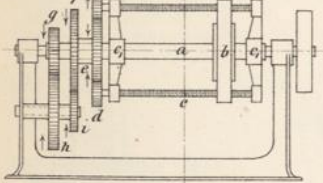

Fig. 11.

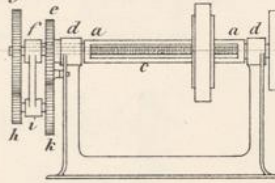

Fig. 12.

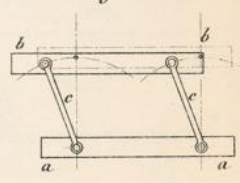

Fig. 14.

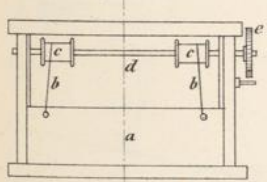

Fig. 15.

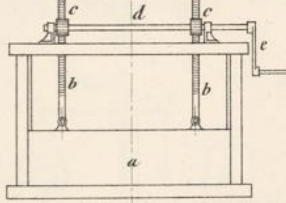

Fig. 16.

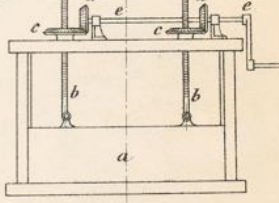

Fig. 13.

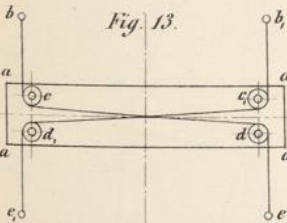

Fig. 17.

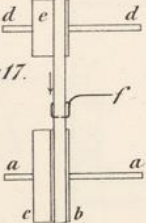
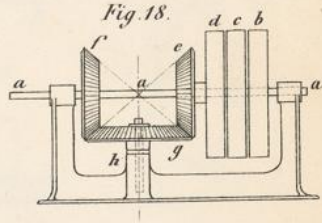

Fig. 18.



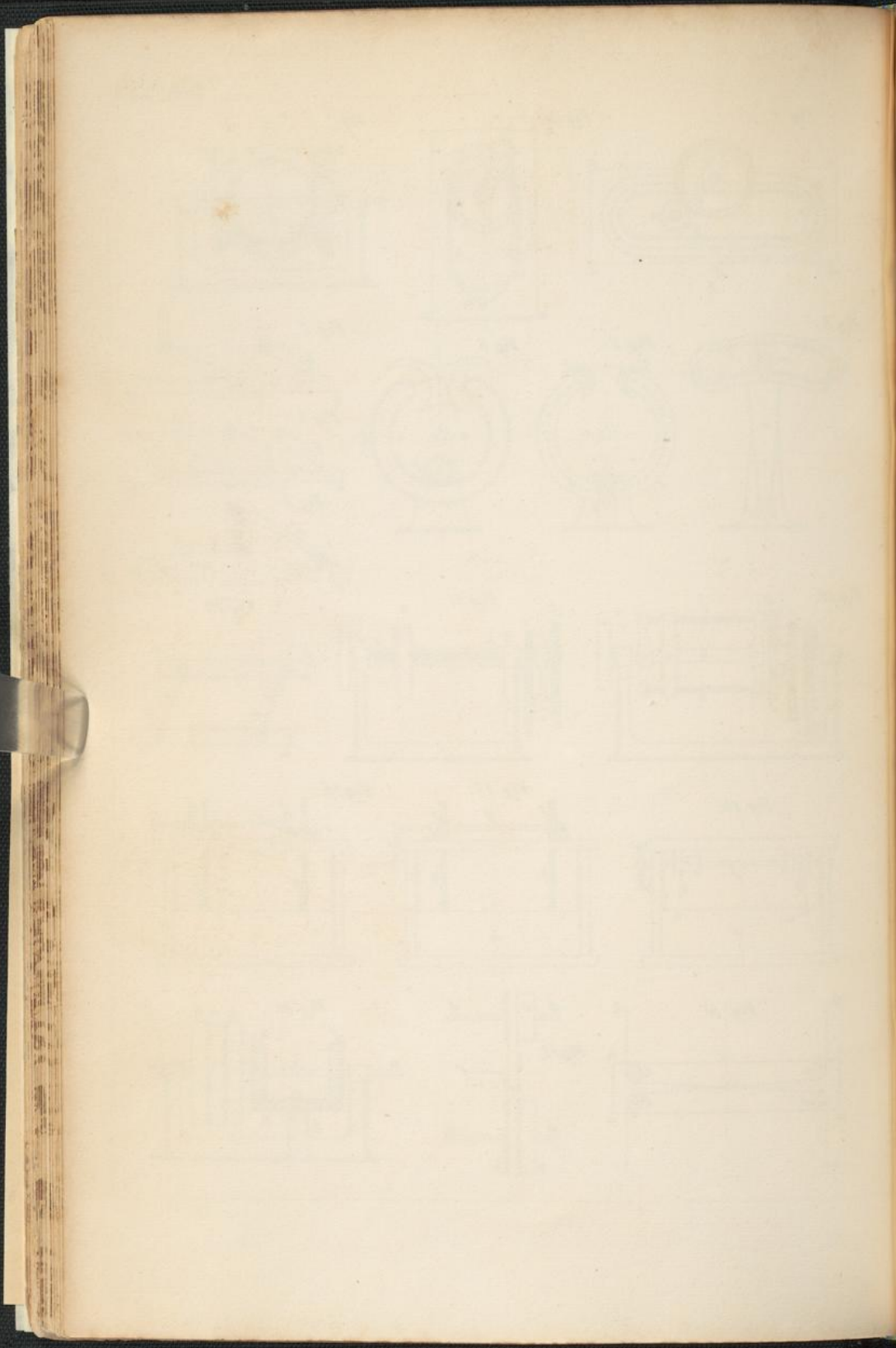

Fig. 1.

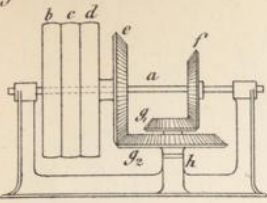

Fig. 2.

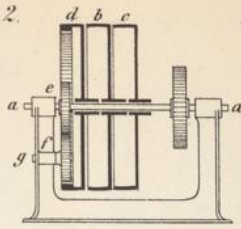

Fig. 3.

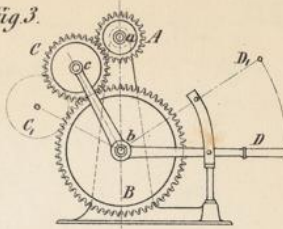

Fig. 4.

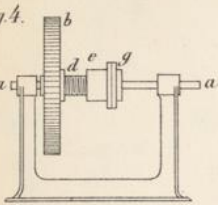

Fig. 5.

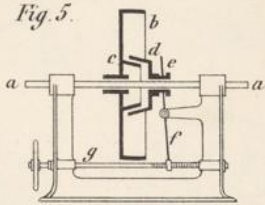

Fig. 6.

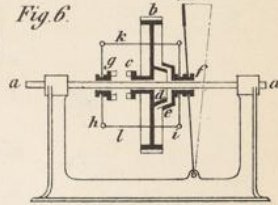

Fig. 7.

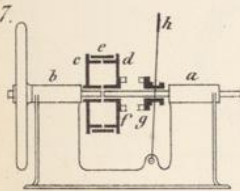

Fig. 8.

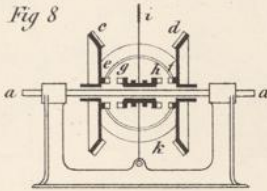

Fig. 9.

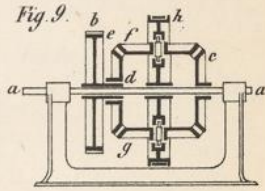

Fig. 10.

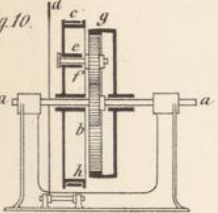

Fig. 11.

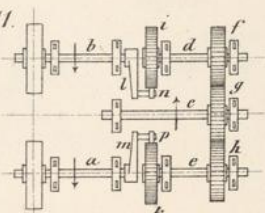

Fig. 12.

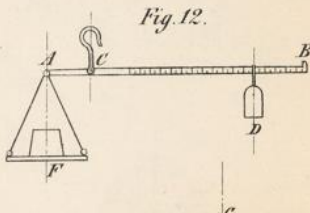

Fig. 13.

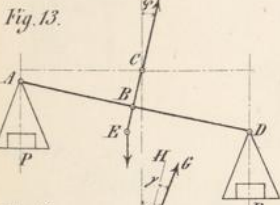

Fig. 15.

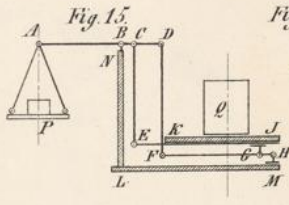

Fig. 17.

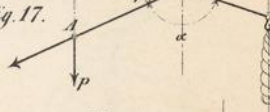

Fig. 14.

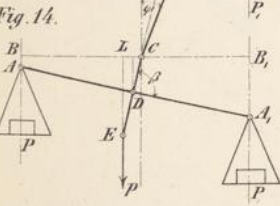

Fig. 16.

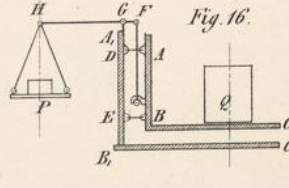
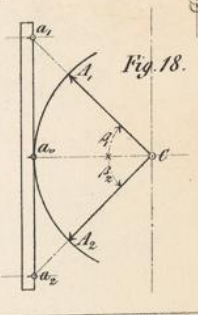

Fig. 18.



Lith. Anst. v. L. Weisendörfer, Carlruhe





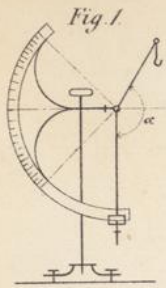

Fig. 1.

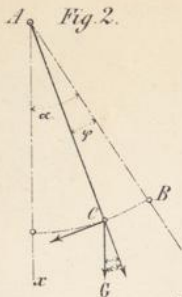

Fig. 2.

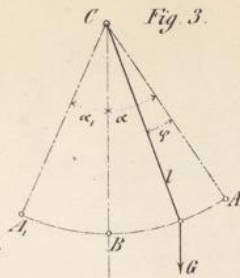

Fig. 3.

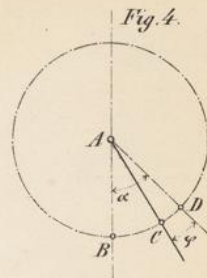

Fig. 4.

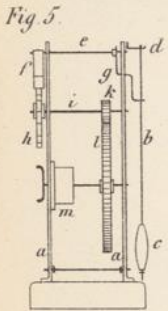

Fig. 5.

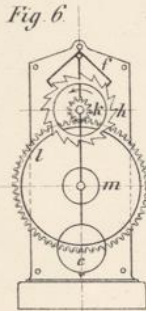

Fig. 6.



Fig. 7.

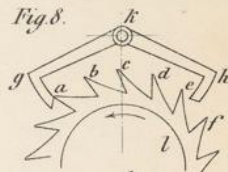

Fig. 8.

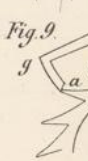

Fig. 9.

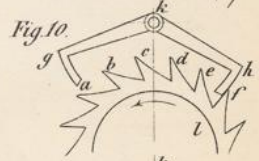

Fig. 10.

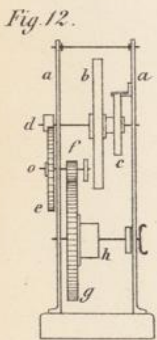

Fig. 12.

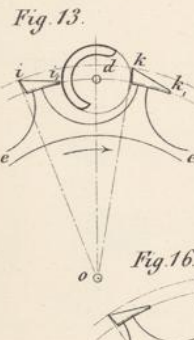

Fig. 13.

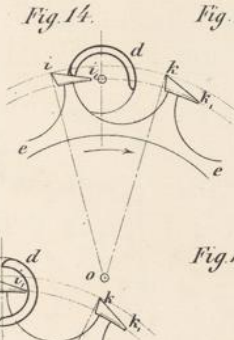

Fig. 14.

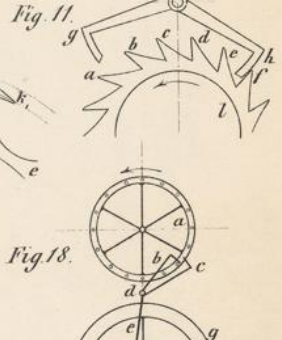

Fig. 11.

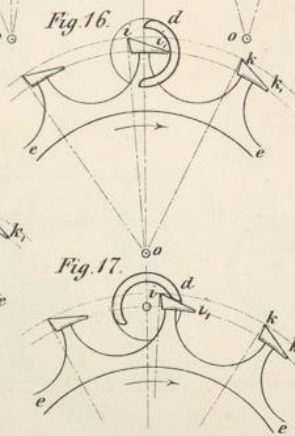

Fig. 16.

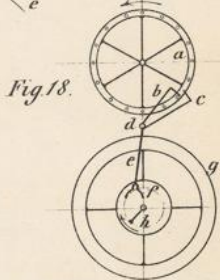

Fig. 18.

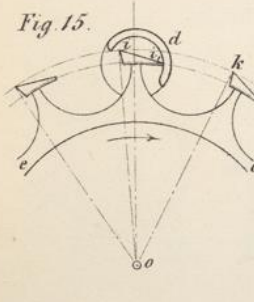

Fig. 15.

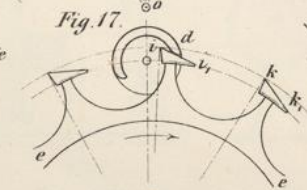

Fig. 17.

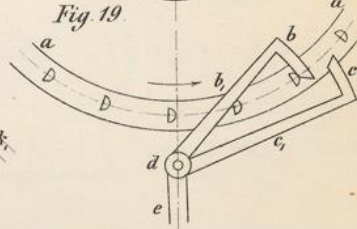
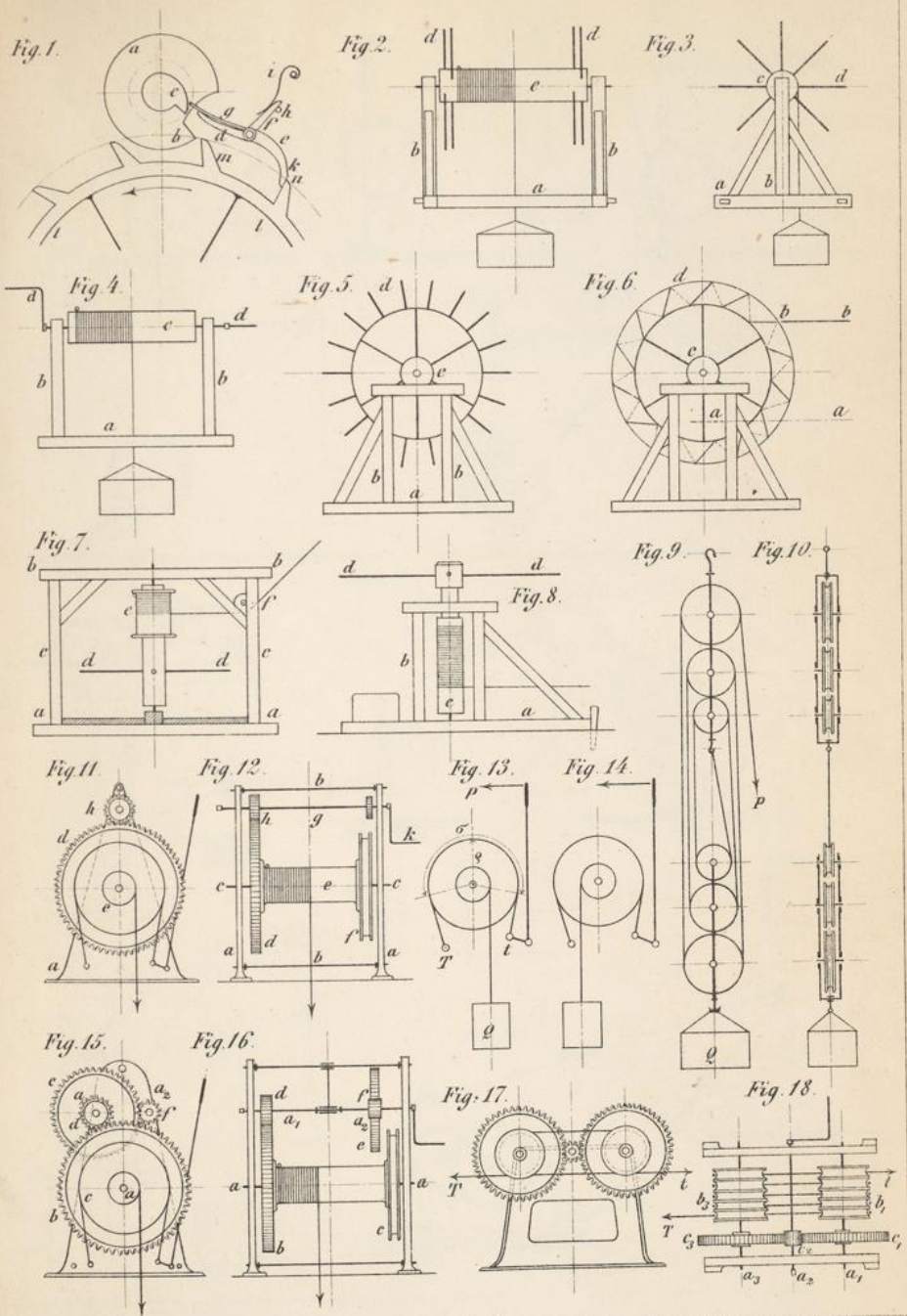

Fig. 19.





Lith. v. I. Geisenhoffer, Carlshaus



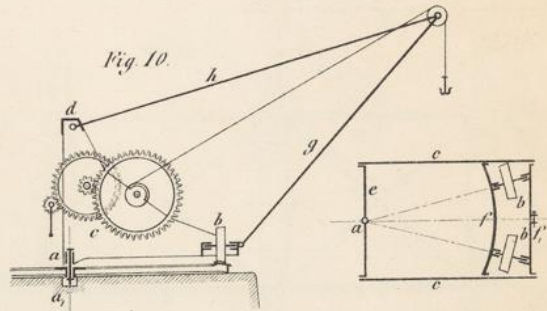
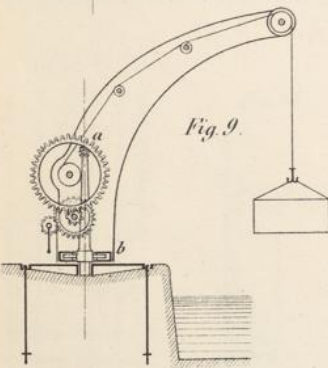
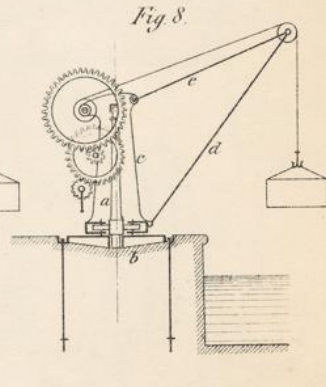
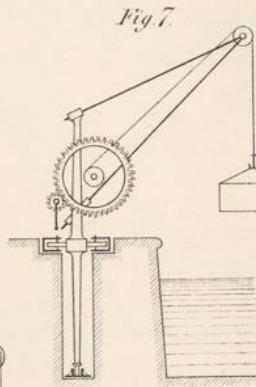
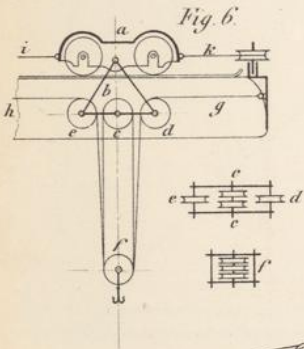
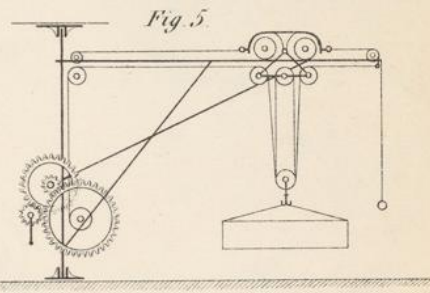
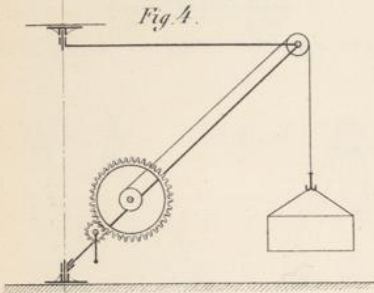
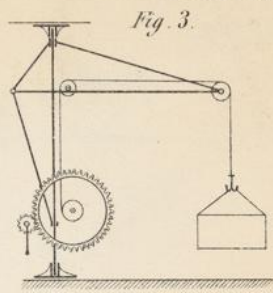
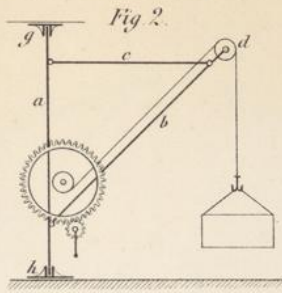
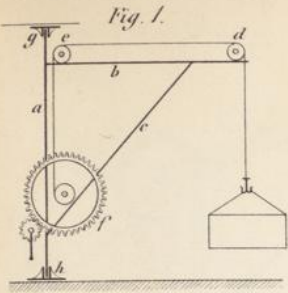



Fig. 1.

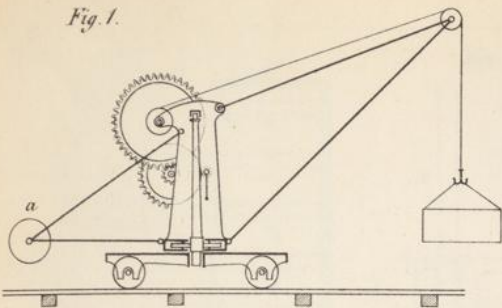

Fig. 2.

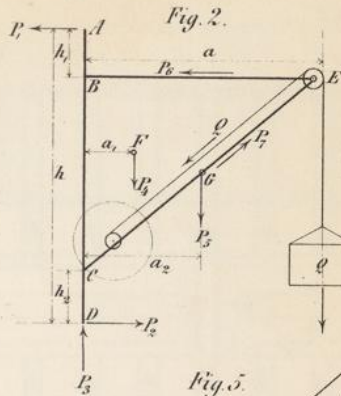

Fig. 3.

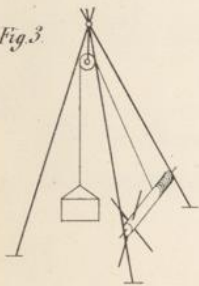

Fig. 4.

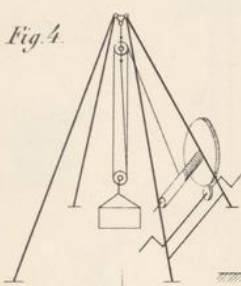

Fig. 5.

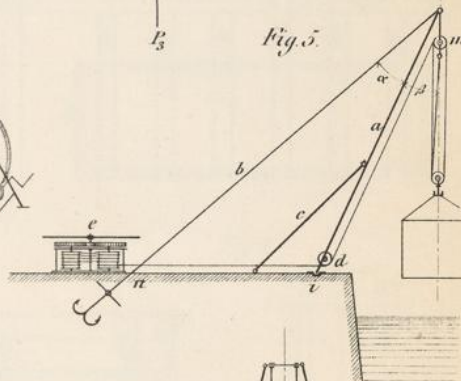

Fig. 7.

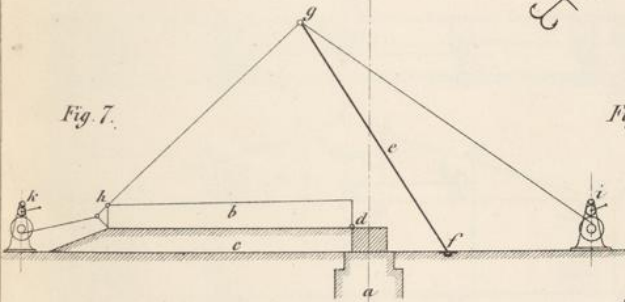

Fig. 6.

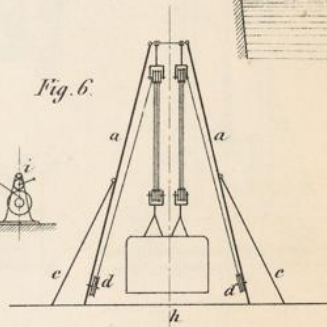

Fig. 8.

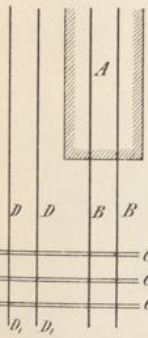

Fig. 10.

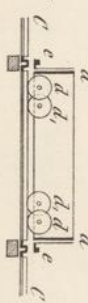
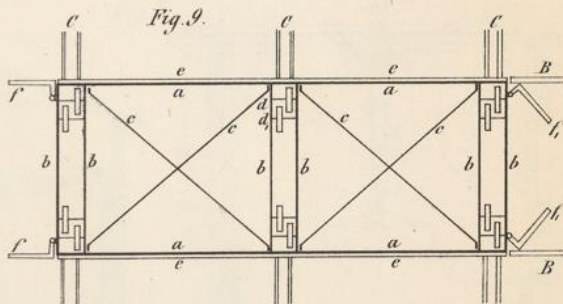
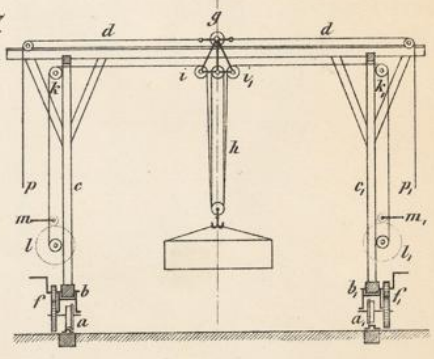
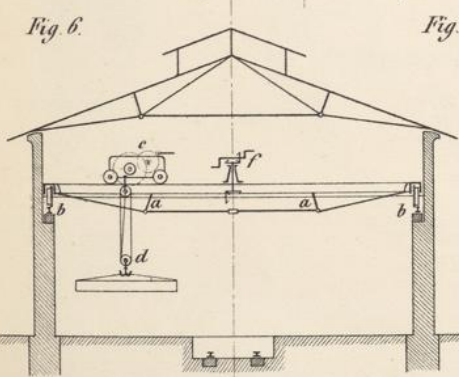
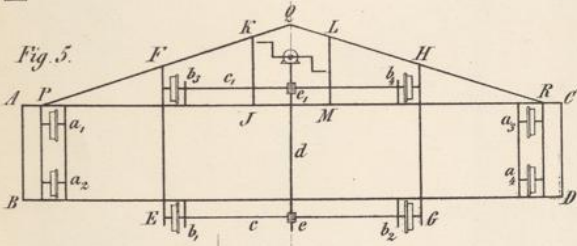
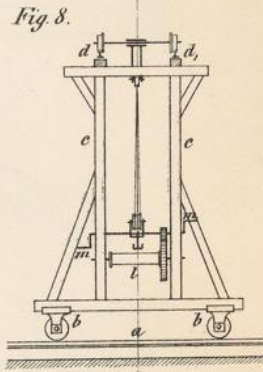
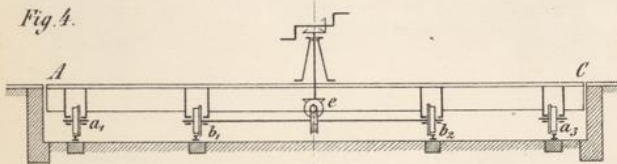
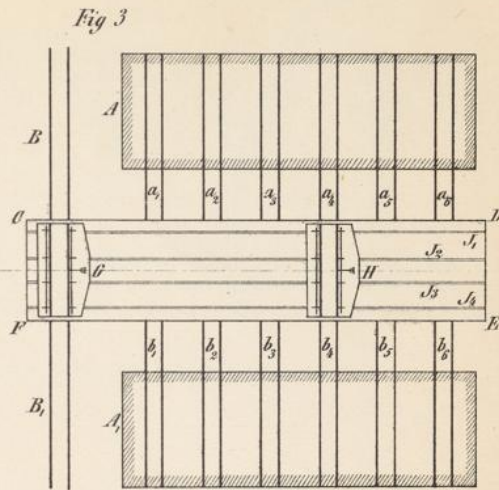
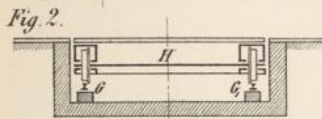
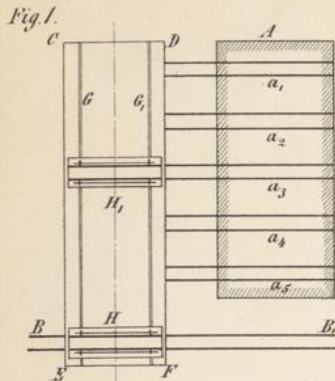

Fig. 9.









Lith. v. L. Heisenbüchel, Karlsruhe



Fig. 1.

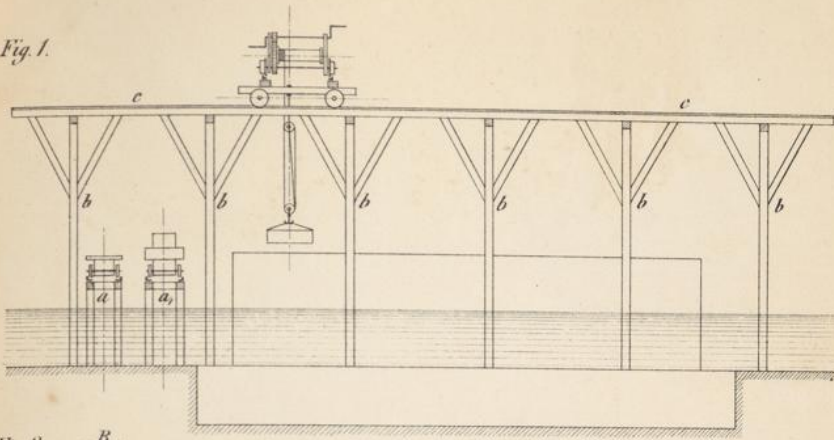

Fig. 2.

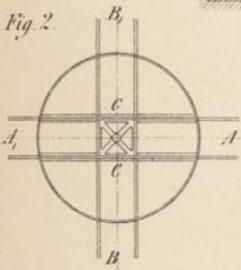

Fig. 3.

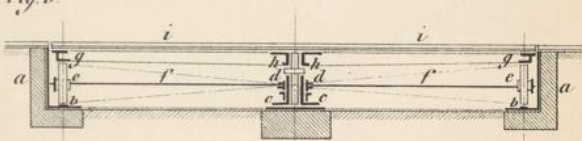
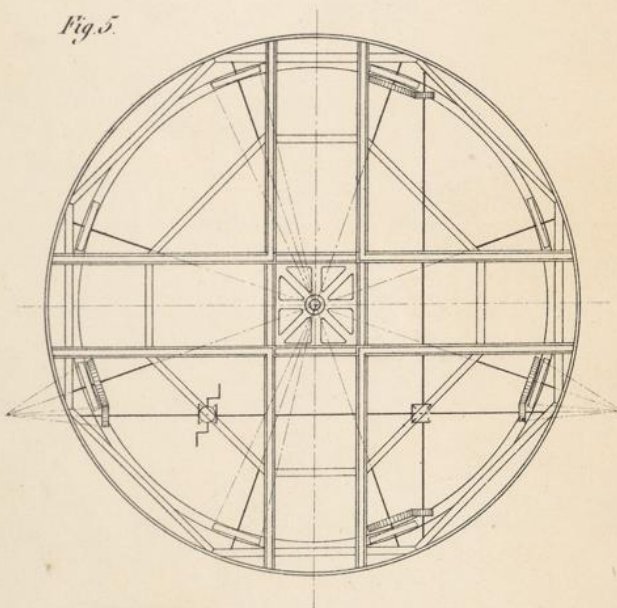

Fig. 4.



Fig. 5.



Lith. v. L. Geisendorfer, Durlach.

