

# **Badische Landesbibliothek Karlsruhe**

**Digitale Sammlung der Badischen Landesbibliothek Karlsruhe**

## **Der Maschinenbau**

Tafeln zu Bd. 1 - 3

**Redtenbacher, Ferdinand**

**Mannheim, 1862 - 1865**

[Band 2]

[urn:nbn:de:bsz:31-278587](https://nbn-resolving.org/urn:nbn:de:bsz:31-278587)

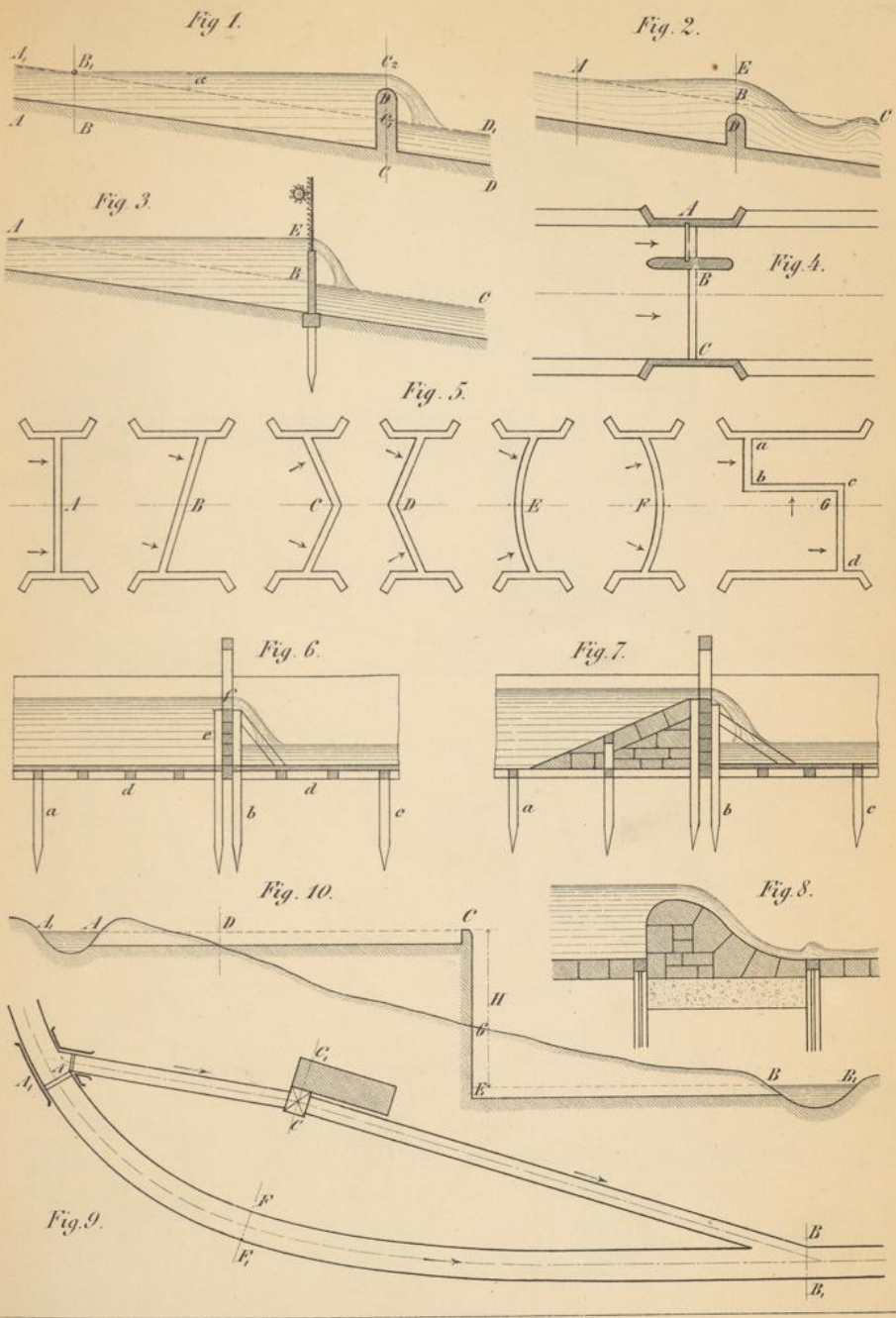

Lehr. v. I. Göttinger, Carlstr. 10.



*[Faint, illegible handwriting on a lined page]*

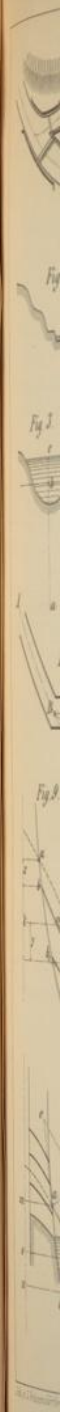

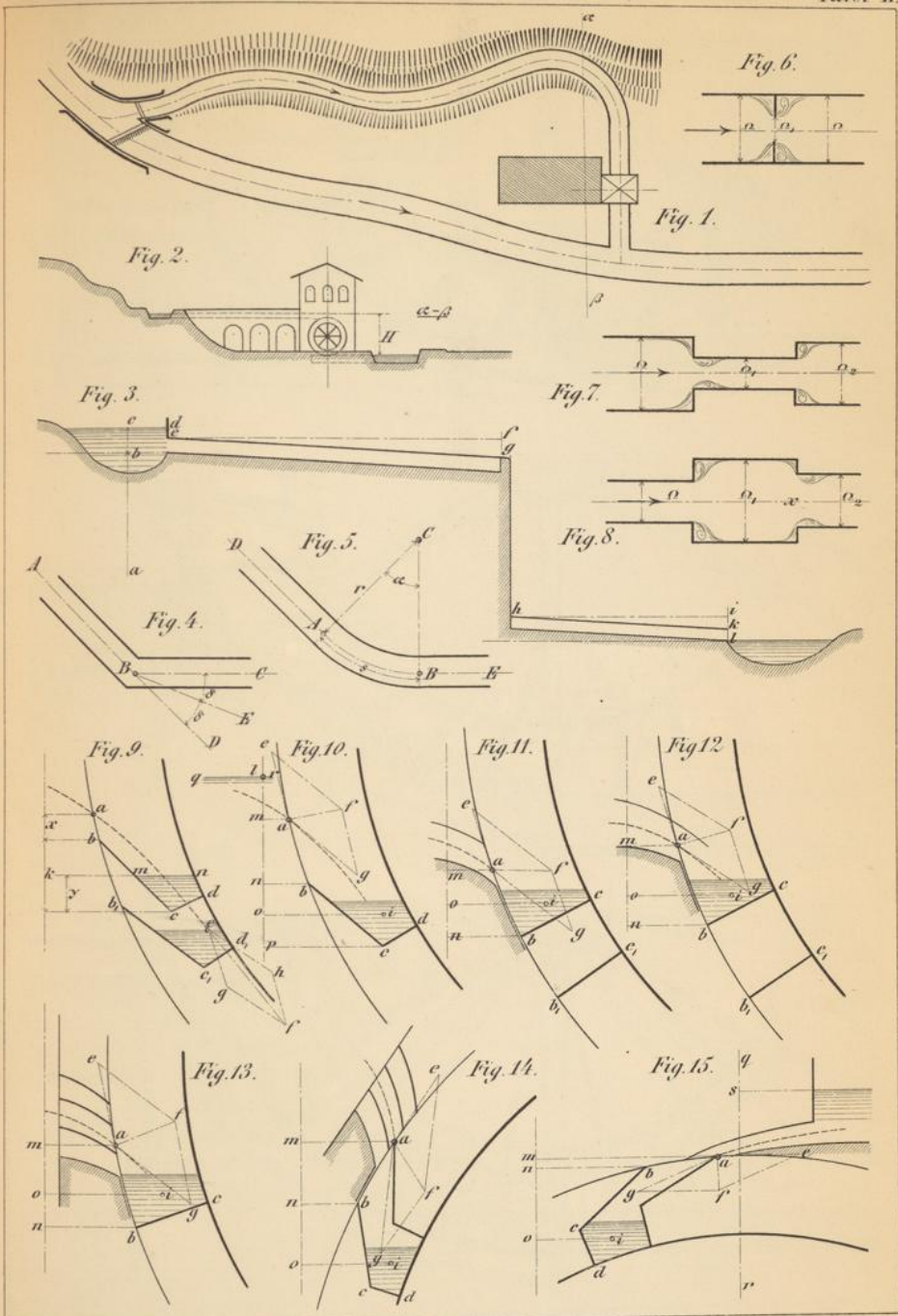

Arch. v. I. Gessensdorfer, Karlsruhe.

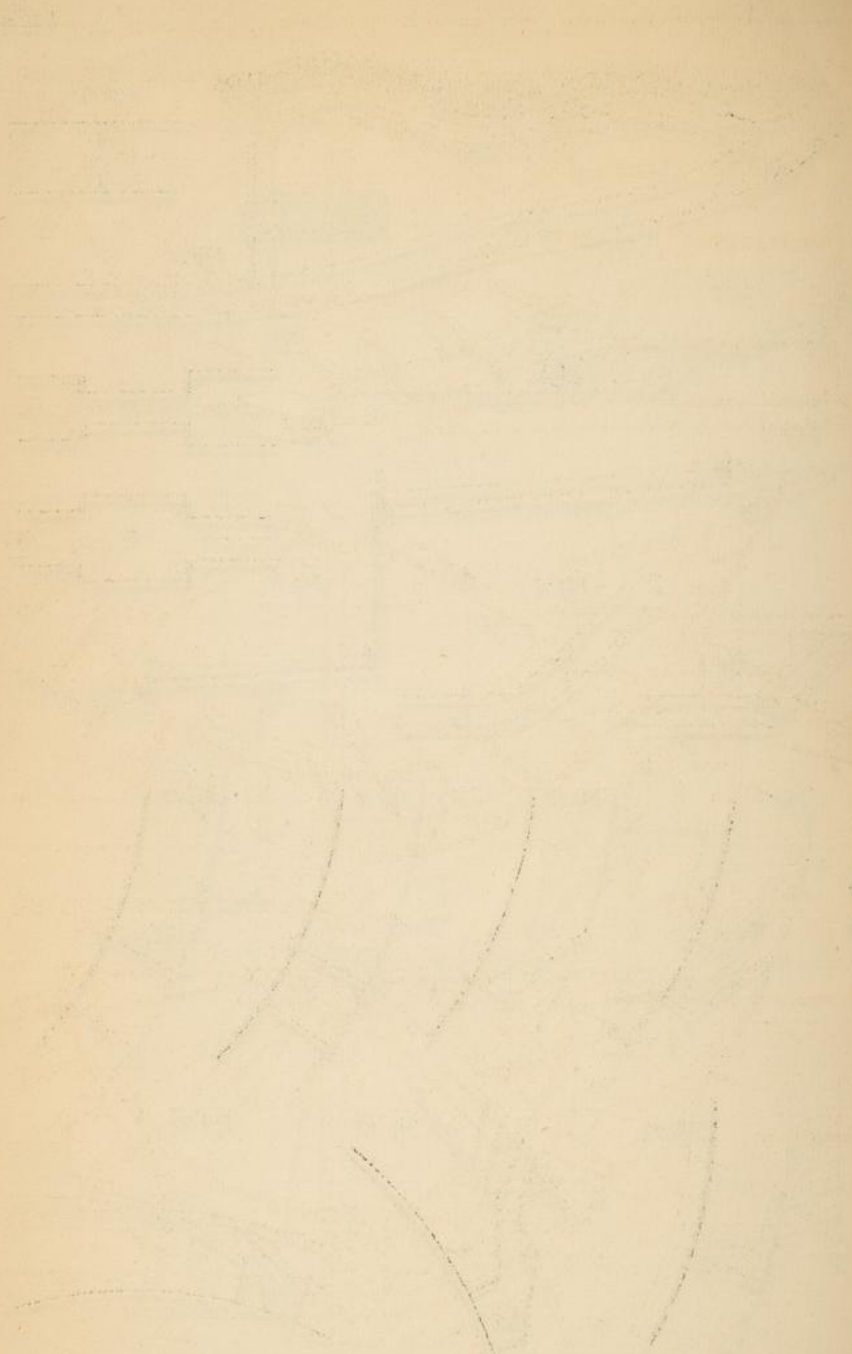

Fig. 1.

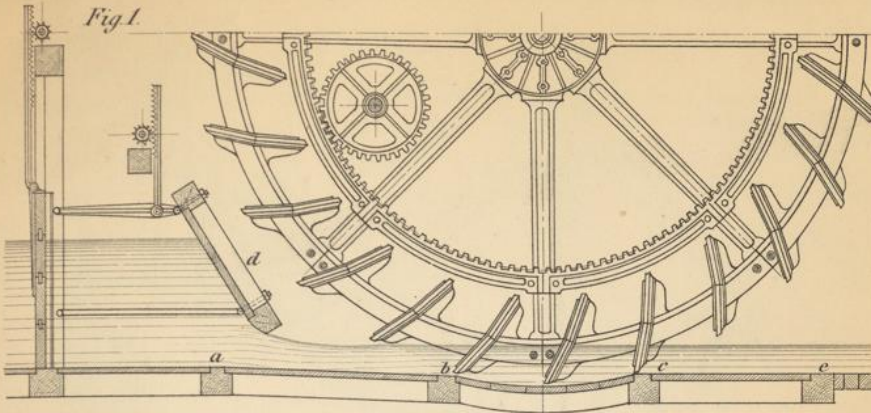

Fig. 2.

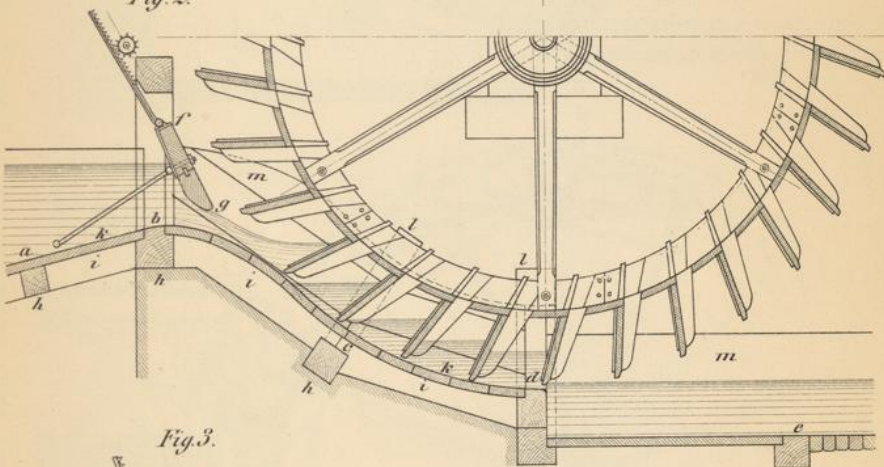
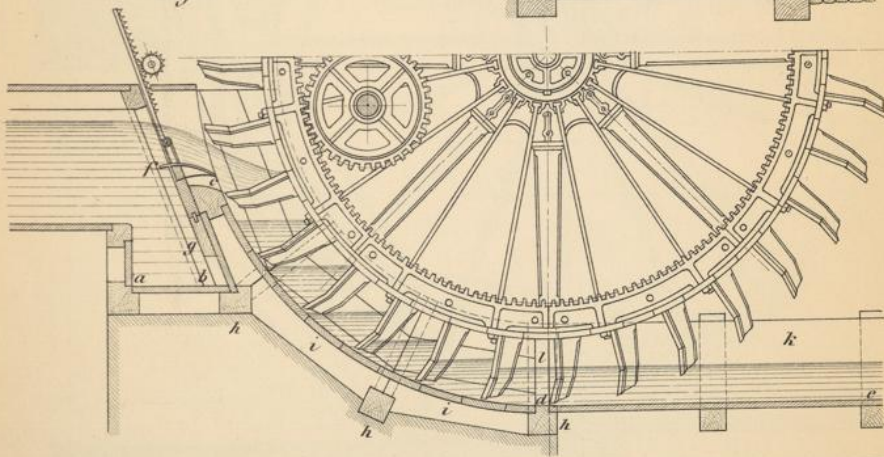

Fig. 3.



Lith. J. Feissendörfer, Karlsruhe

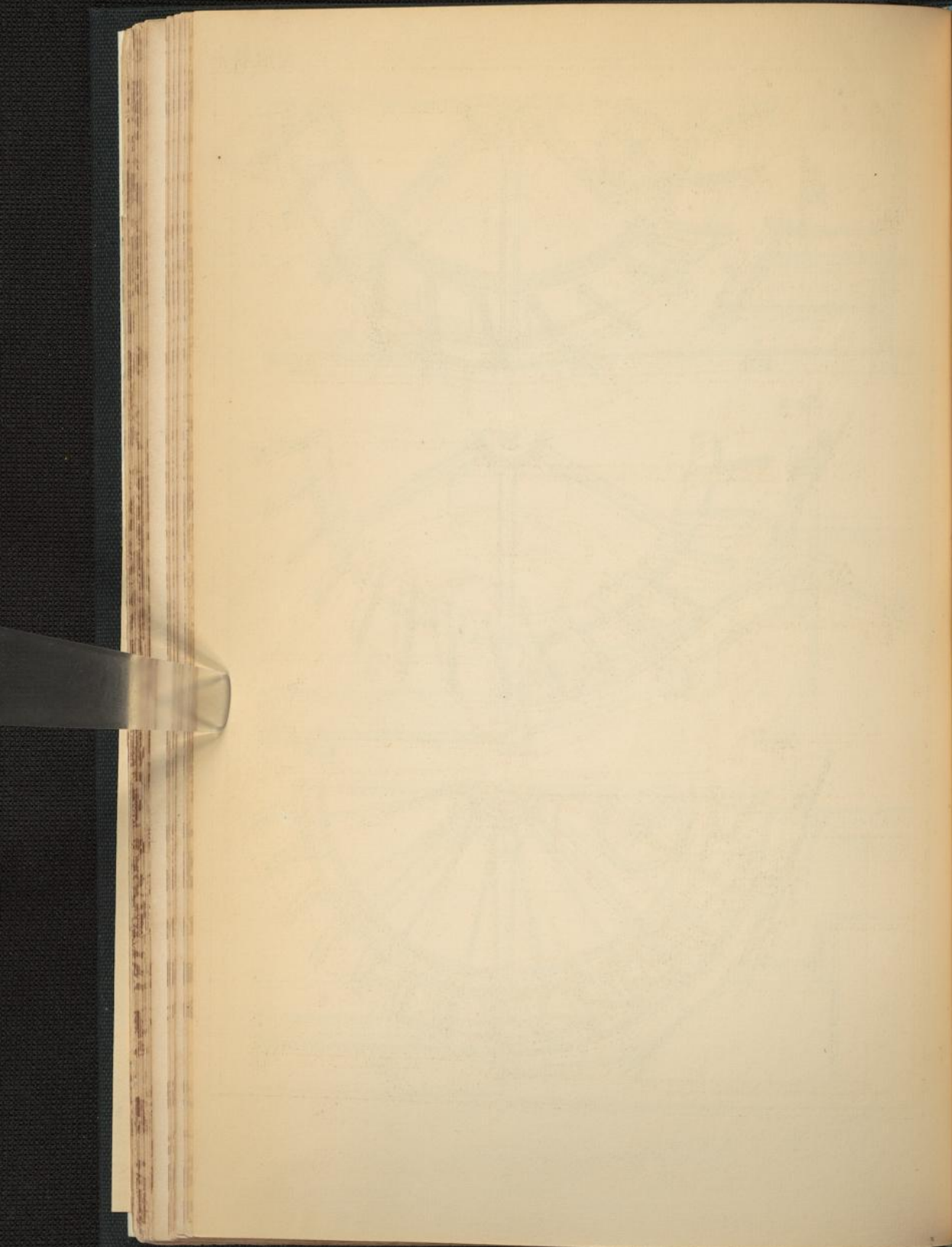

Fig 1



Fig



Fig. 1.

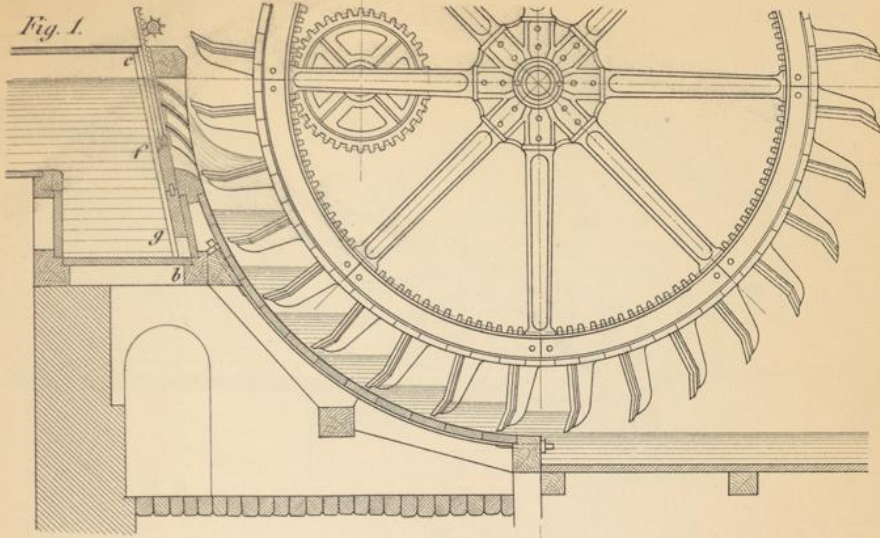
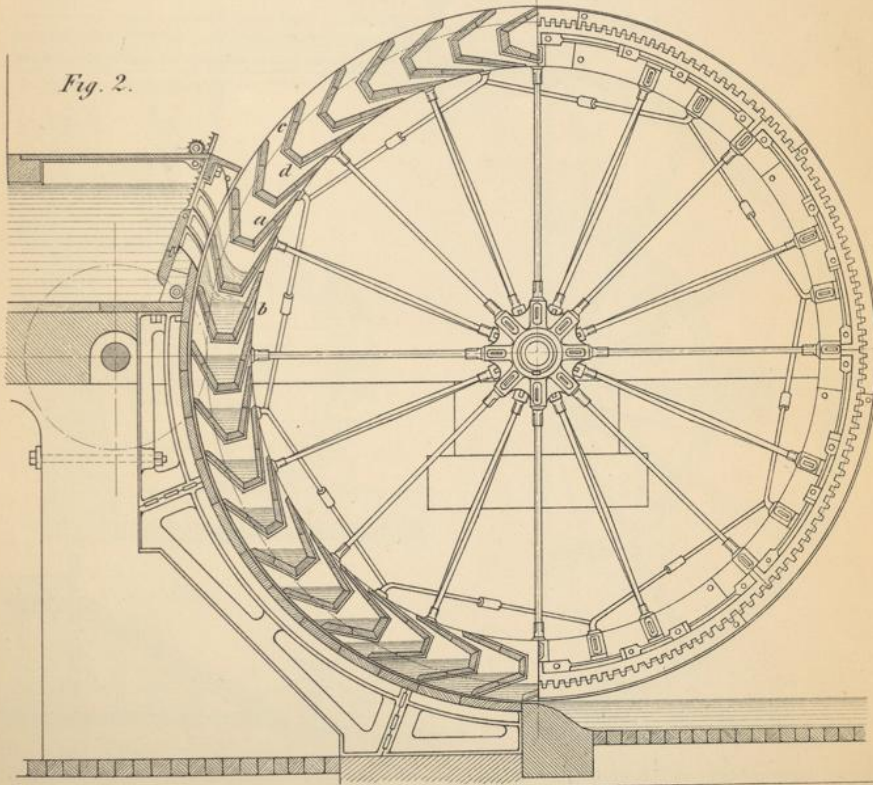

Fig. 2.



*Entw. von L. Geisenharter, Karlsruhe.*





Fig. 1.

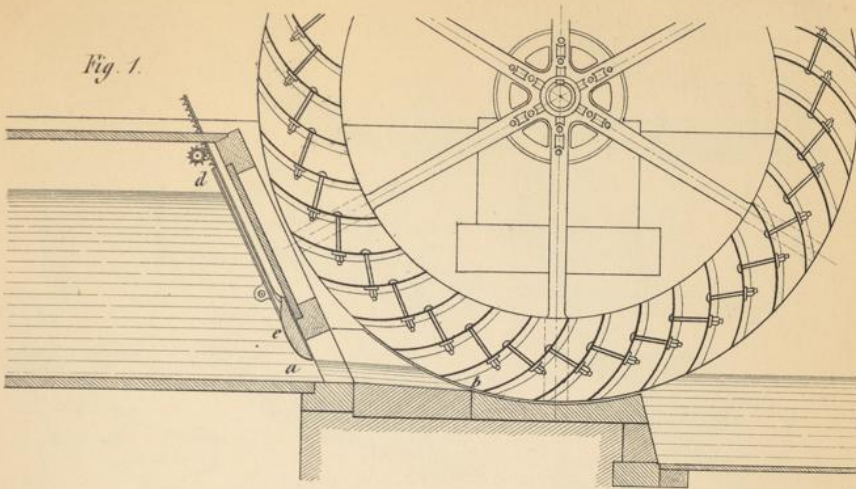

Fig. 2.

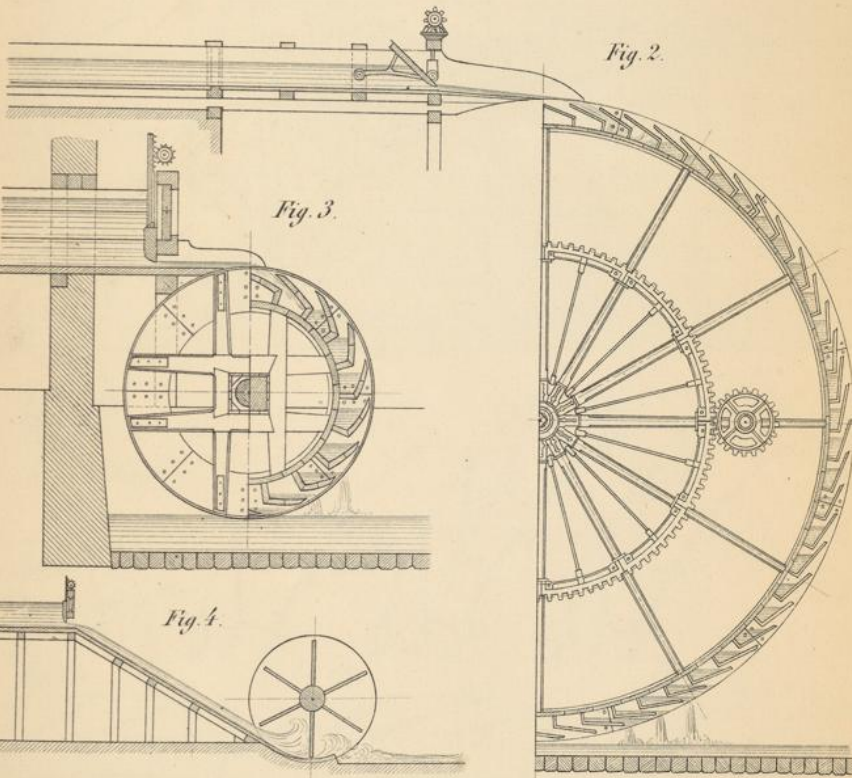

Fig. 3.

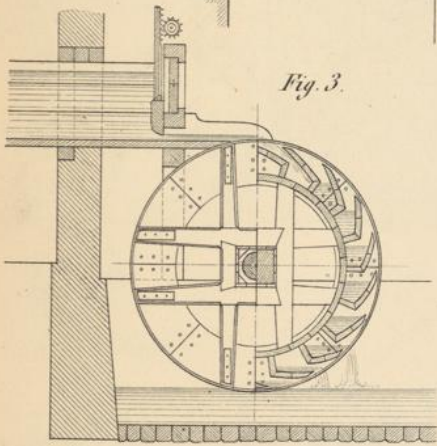
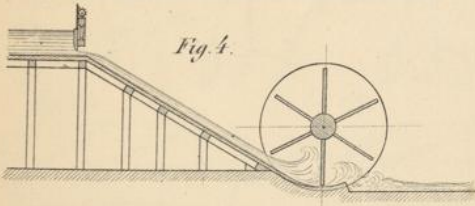

Fig. 4.



Zsch. u. L. Feisensdorf's Carthagen







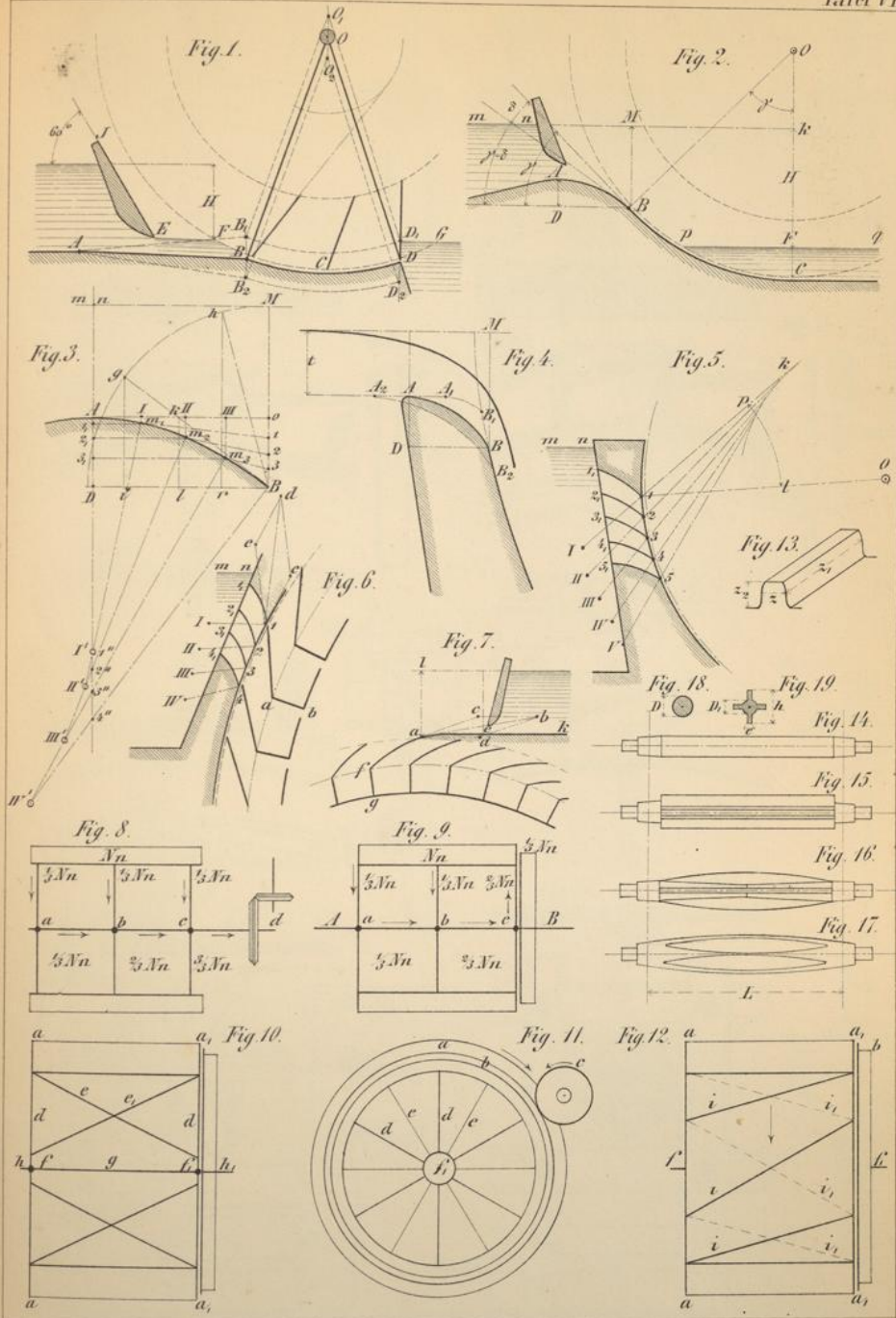

Arch. v. L. Geisenharter, Carlsruhe.



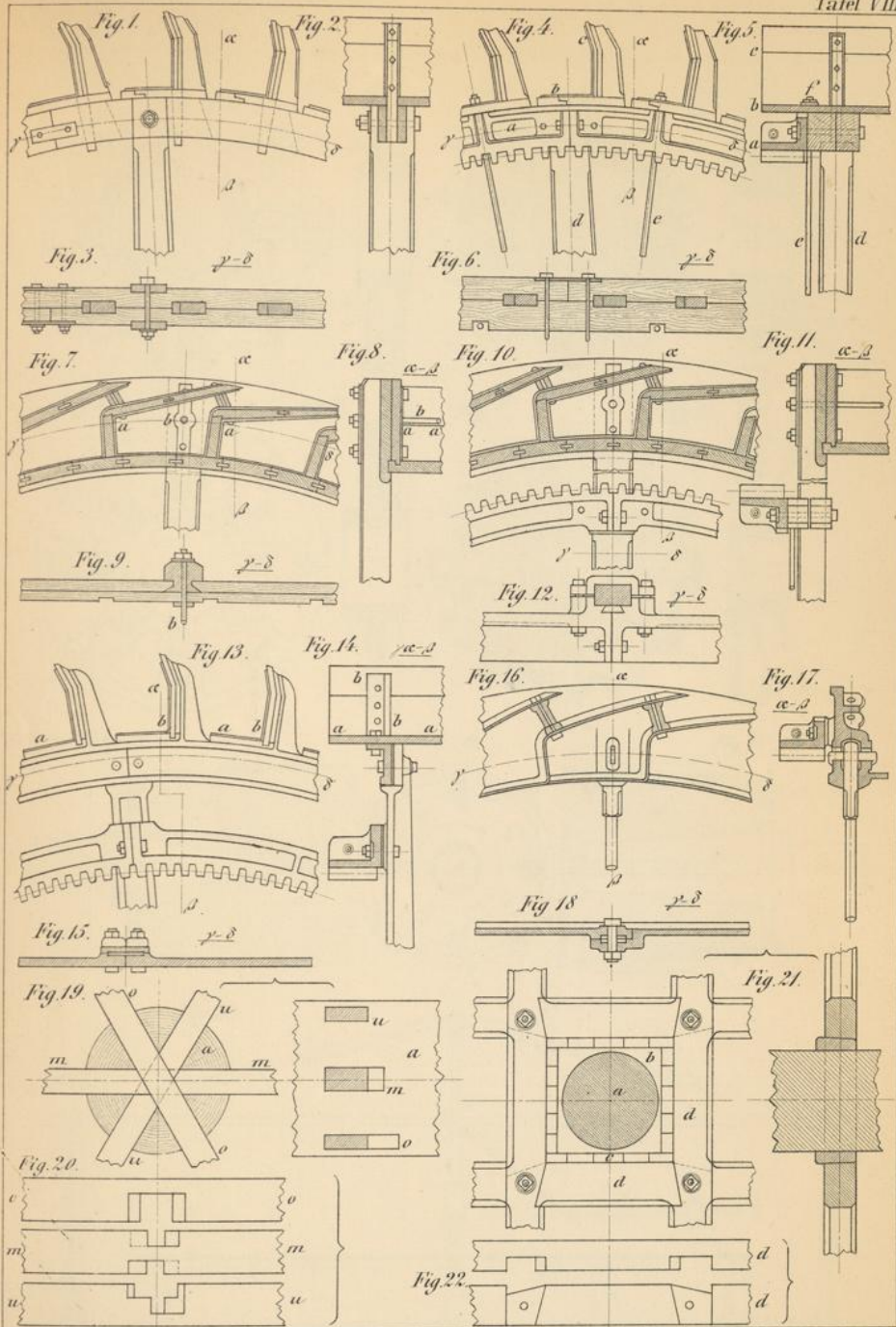

Lehr u. L. Gelenkdörfer für Carrouse.



Fig. 1



Fig. 2



Fig. 3

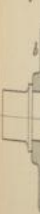

Fig. 1.

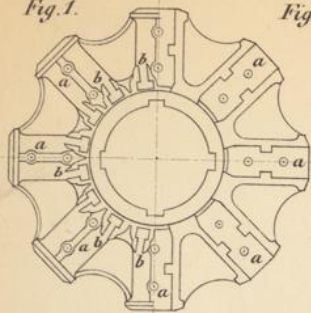

Fig. 2.

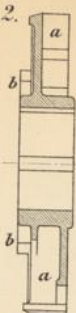

Fig. 5.

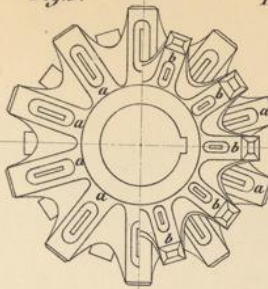

Fig. 6.

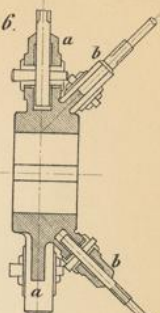

Fig. 3.

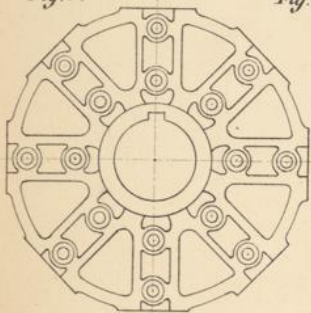

Fig. 4.

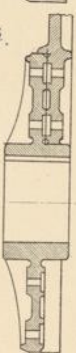

Fig. 7.

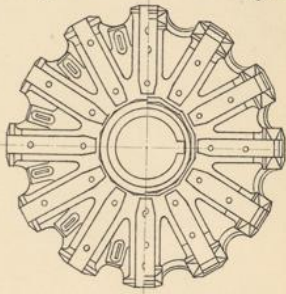

Fig. 8.

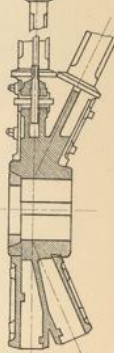

Fig. 9.

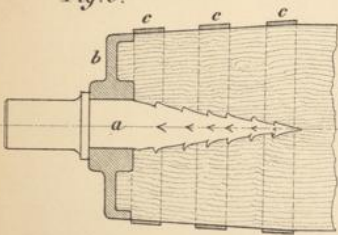

Fig. 11.



Fig. 10.

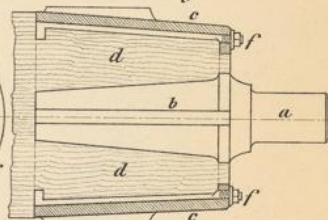
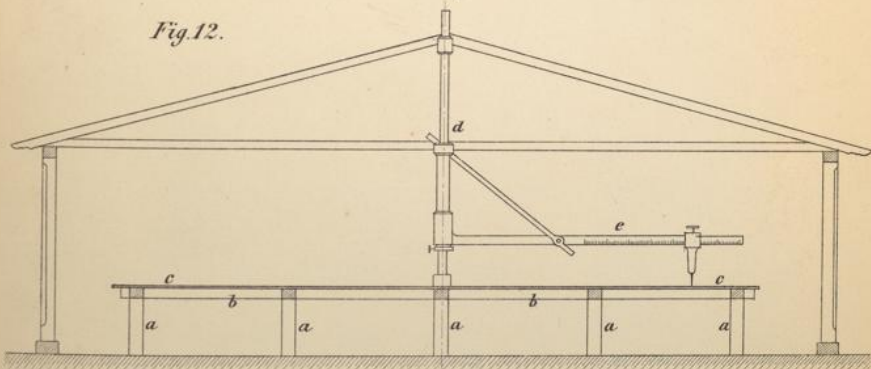

Fig. 12.



Lith. v. L. Geisenhörter, Karlsruhe.

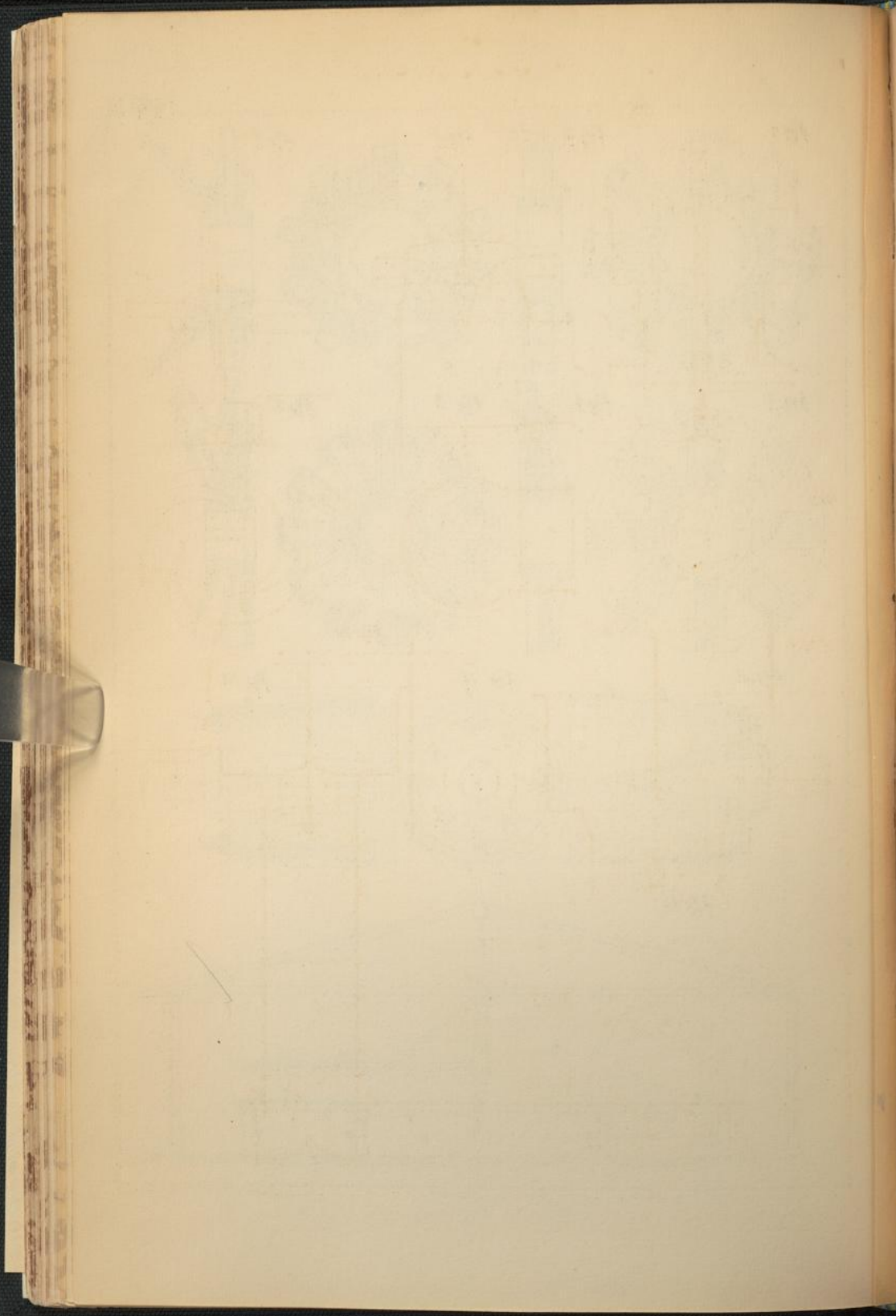

Fig. 1.

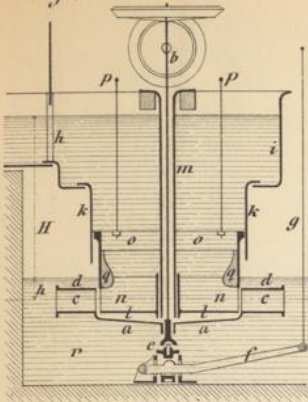

Fig. 3.

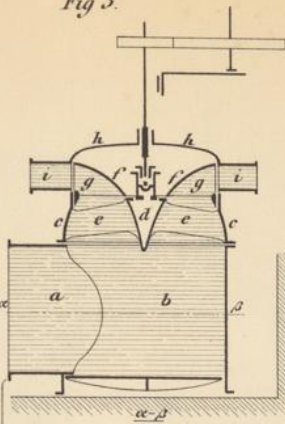

Fig. 4.

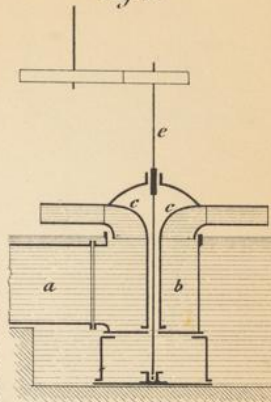

Fig. 2.

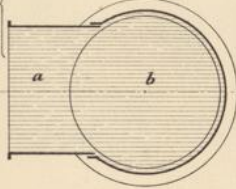
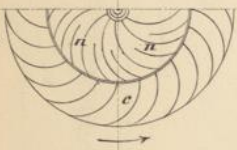

Fig. 5.

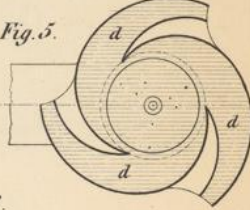

Fig. 6.

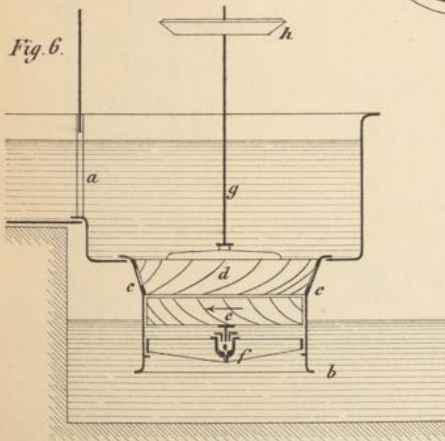

Fig. 8.

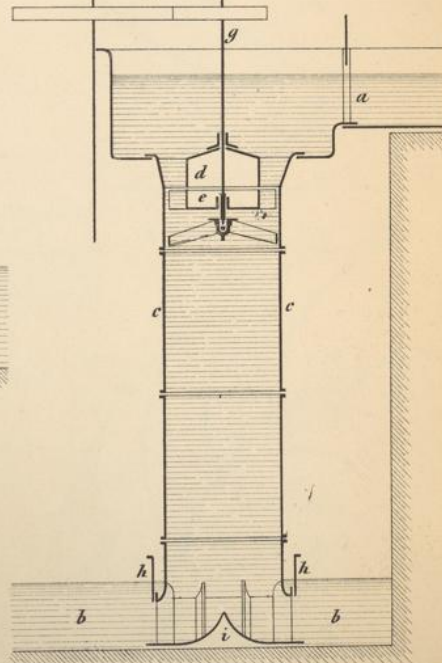
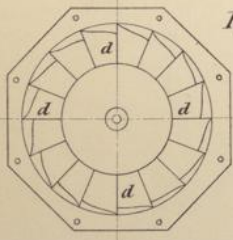
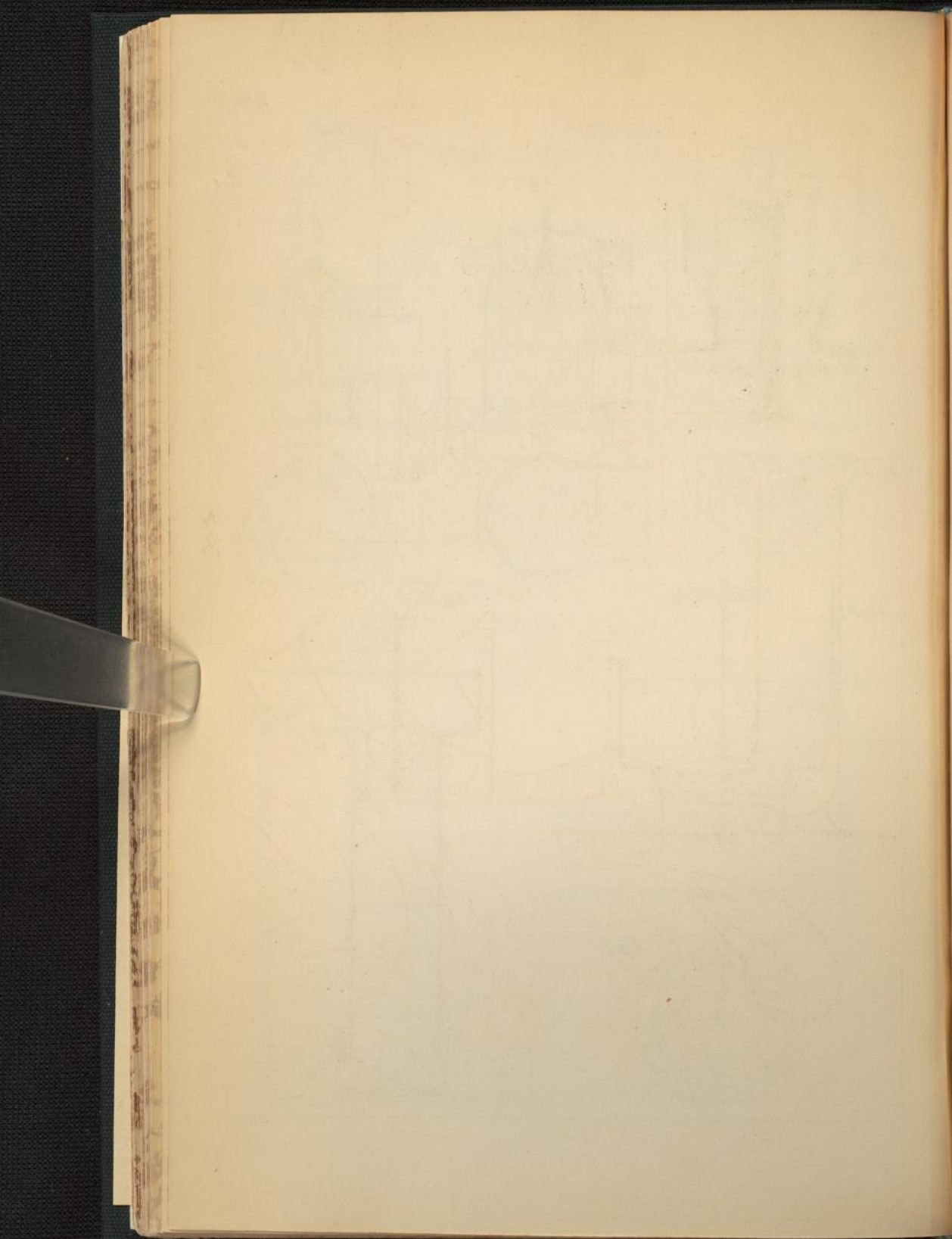
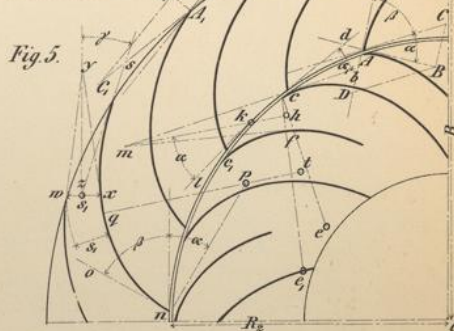
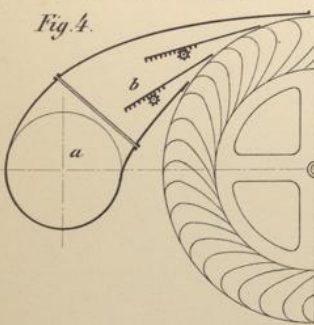
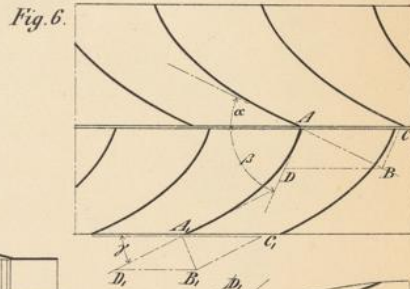
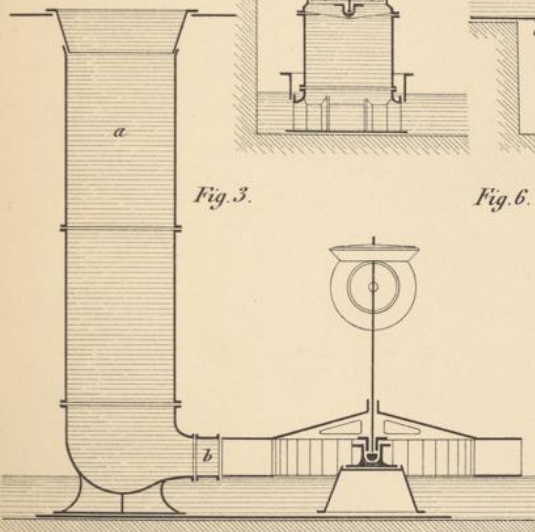
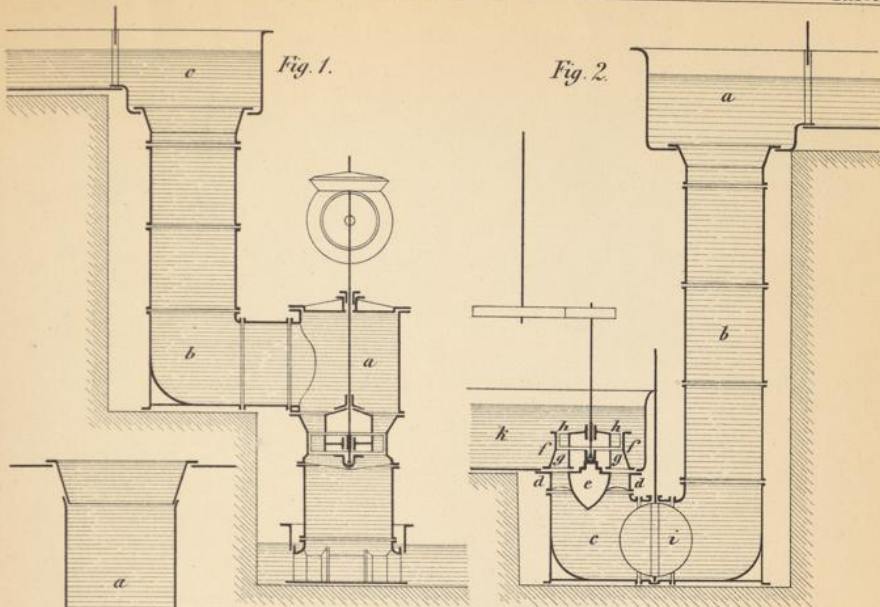

Fig. 7.







Lith. v. l. Weisendörfer, Carlsruhe

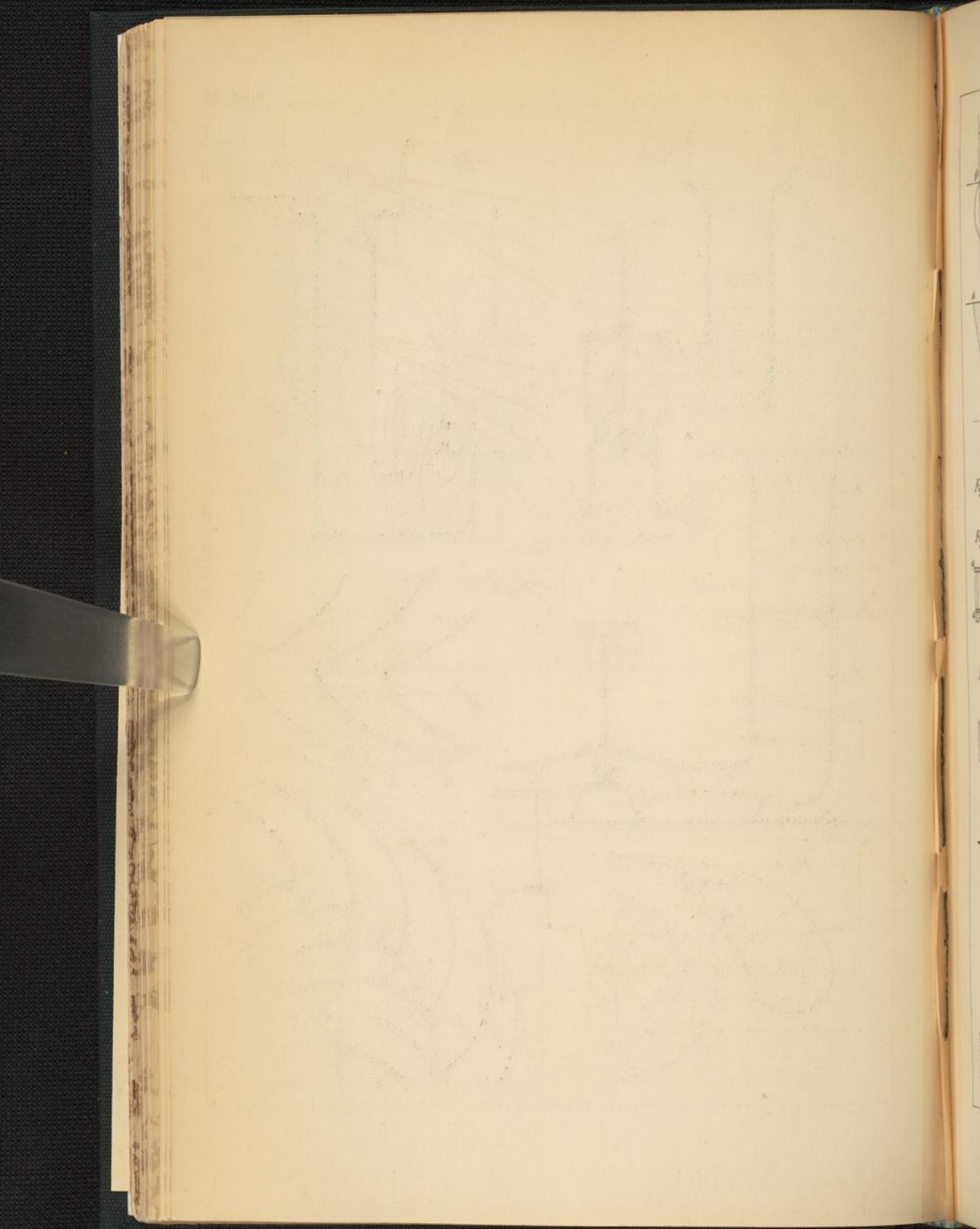

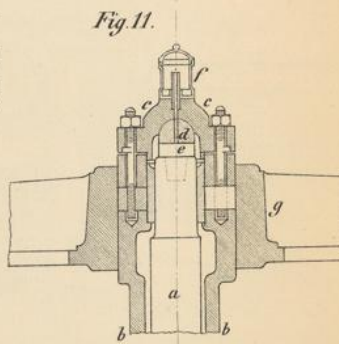
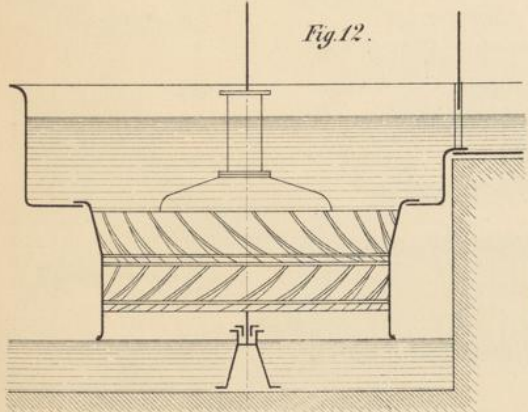
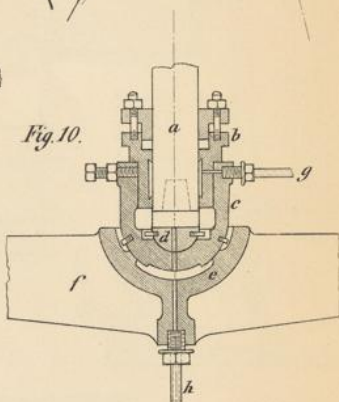
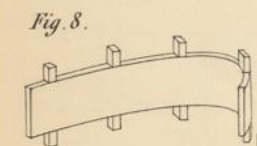
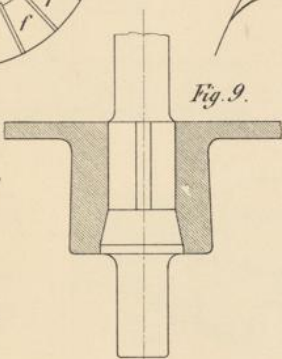
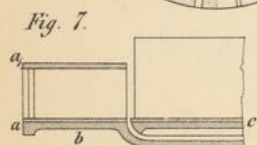
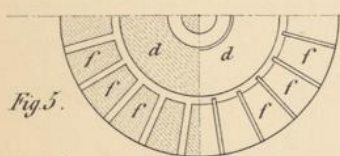
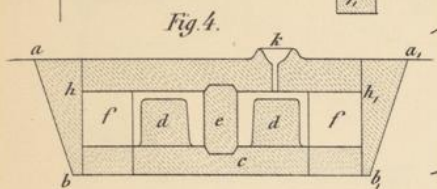
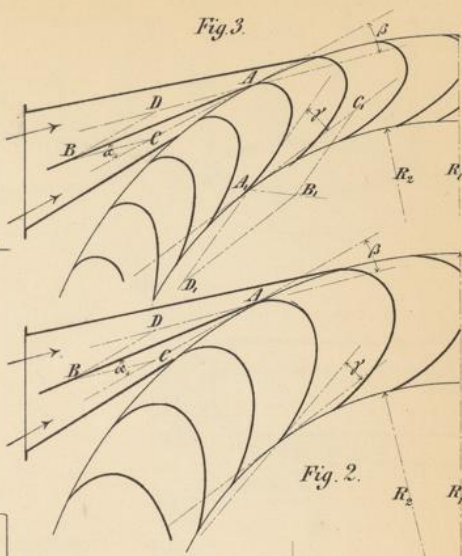
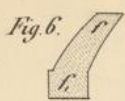
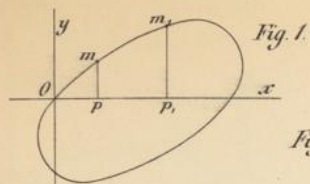

142 v. l. Badenischer Kunst- und Gewerbe-Verein 1894



1871  
1872

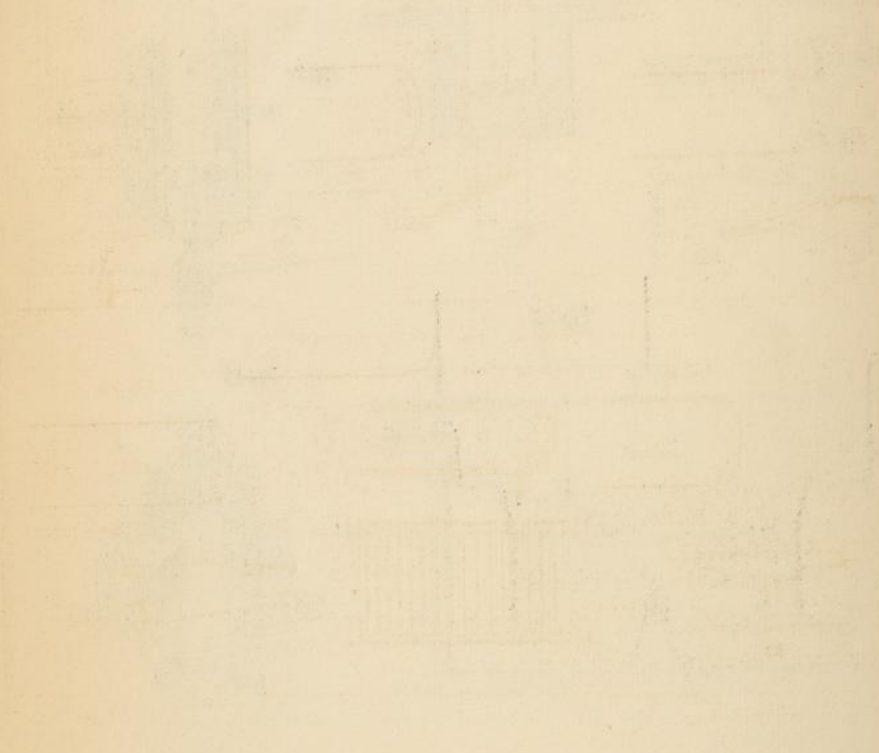
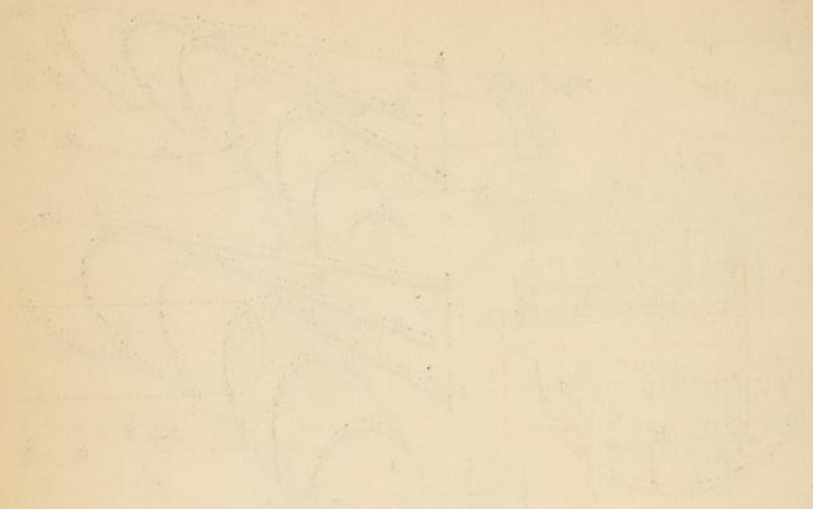

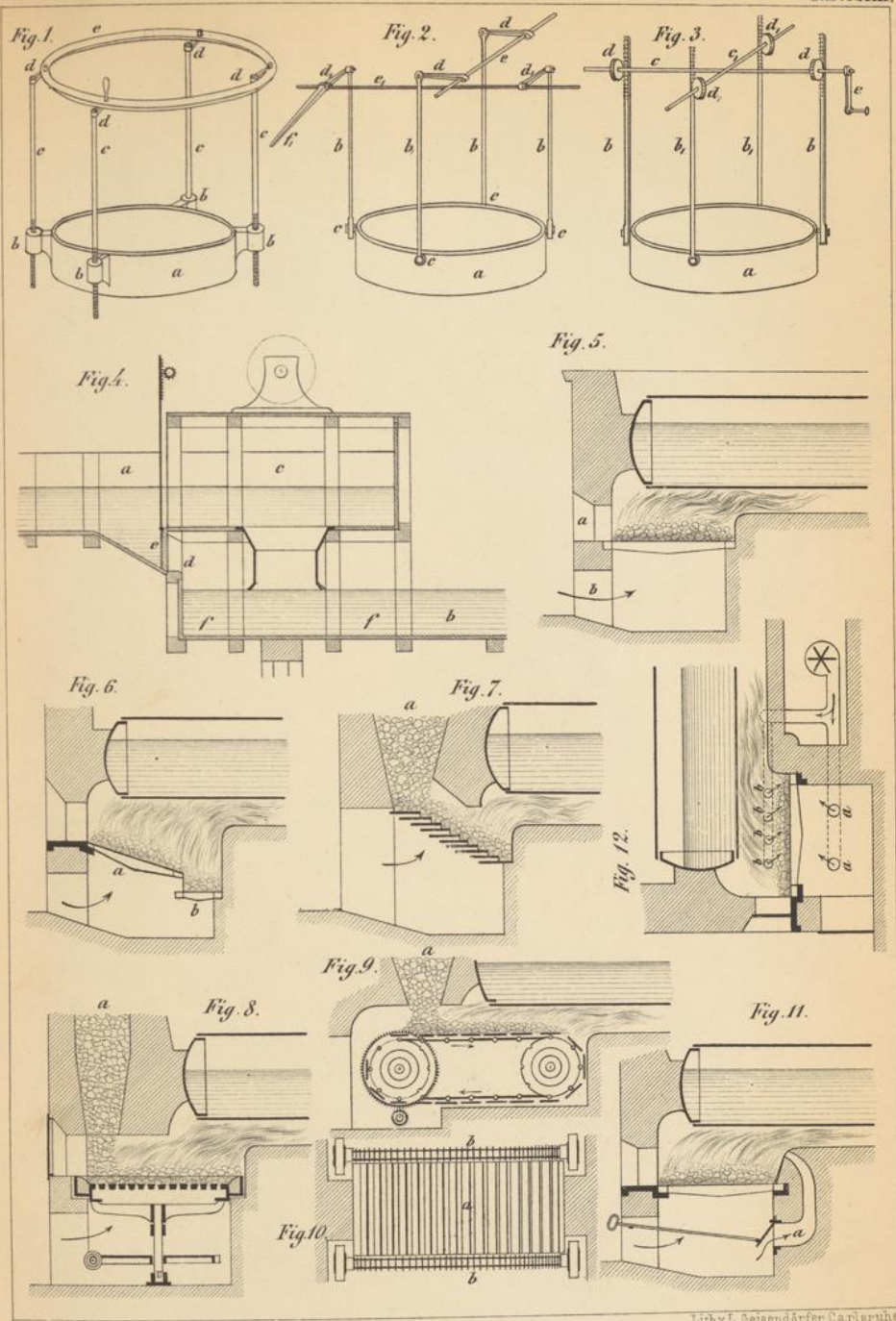

Lith. v. L. Geisendörfer, Carlruhe



Fig. 1.

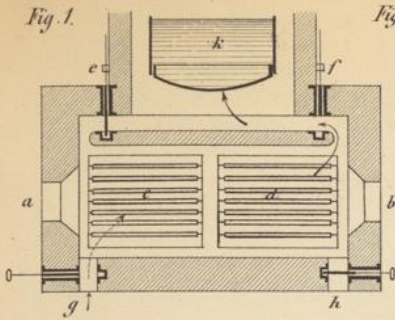

Fig. 2.

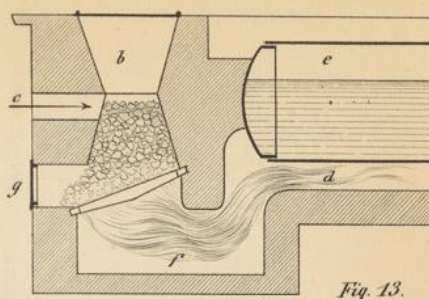

Fig. 3.

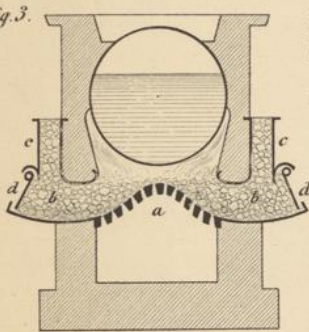

Fig. 4.

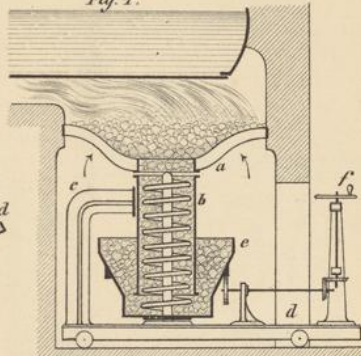

Fig. 13.

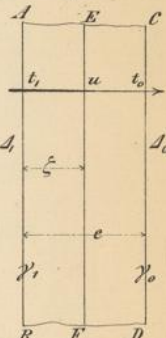

Fig. 5.

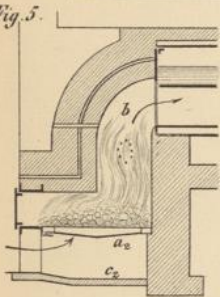

Fig. 6.

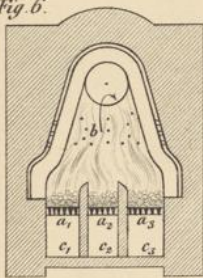

Fig. 8.

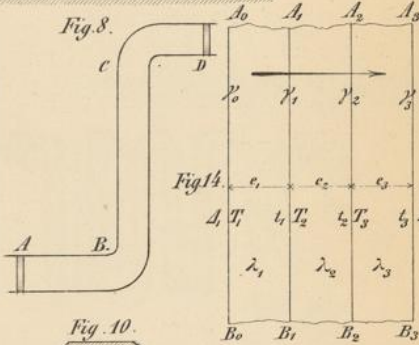

Fig. 7.

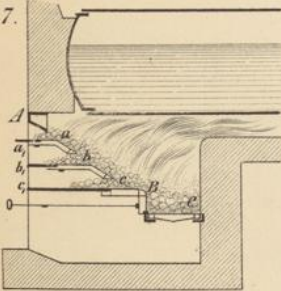

Fig. 9.

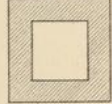

Fig. 10.

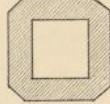

Fig. 11.



Fig. 12.

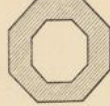
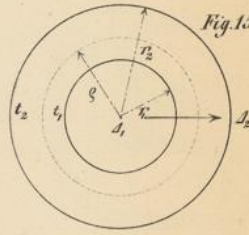
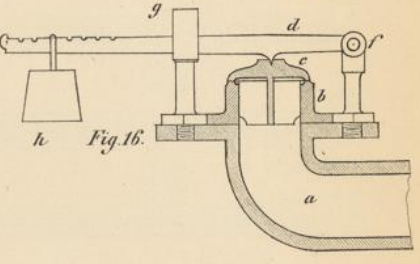
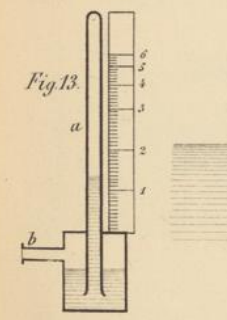
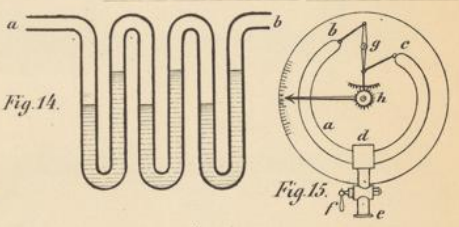
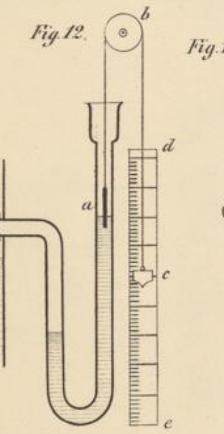
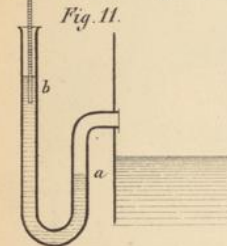
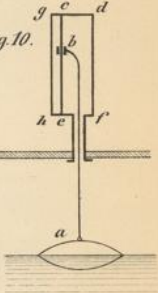
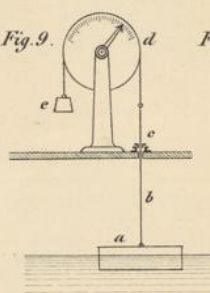
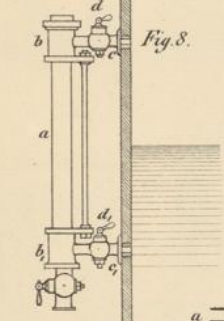
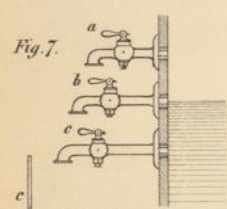
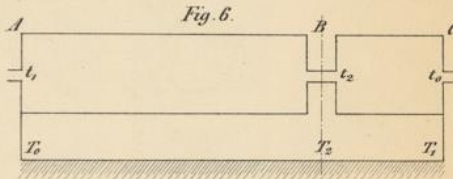
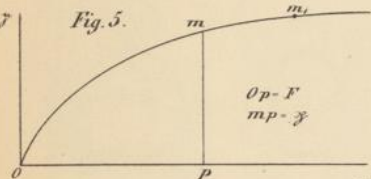
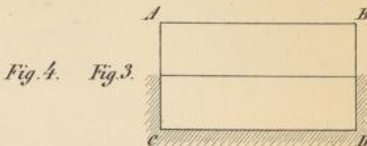
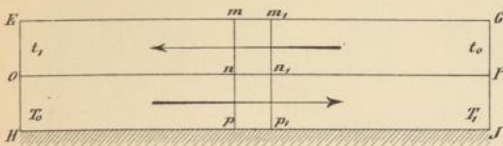
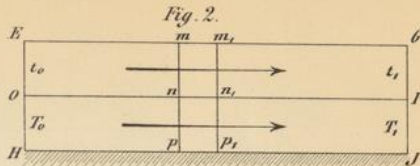
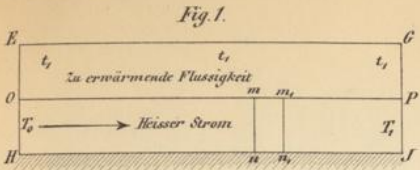

Fig. 15.









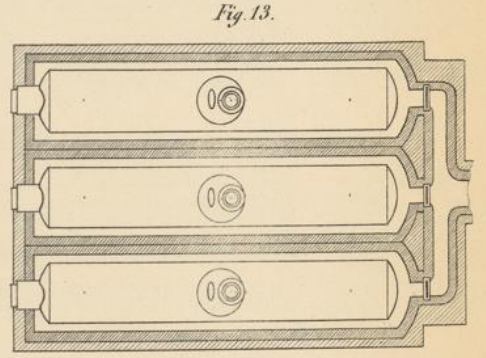
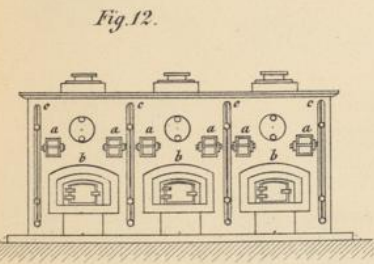
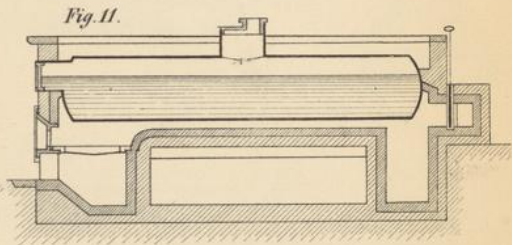
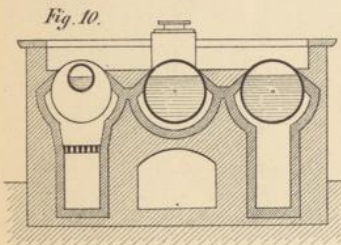
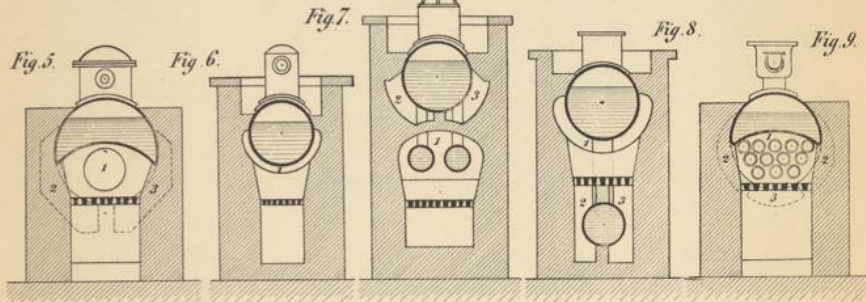
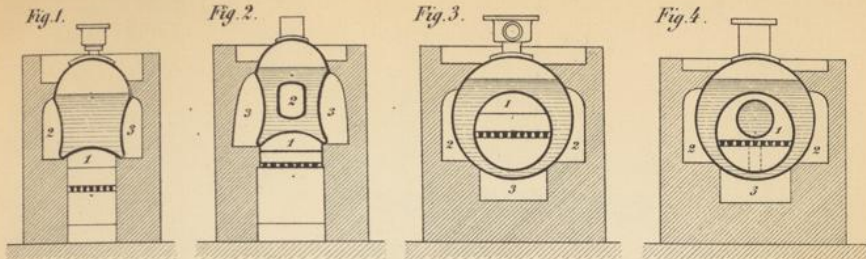

Lith.v.L. Geisendorfer, Carlsruhe





Fig. 1.

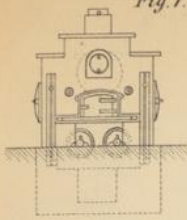

Fig. 2.

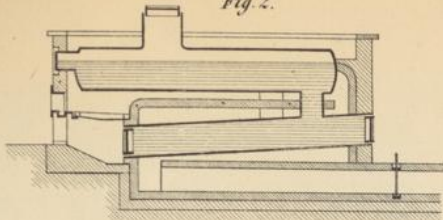

Fig. 3.

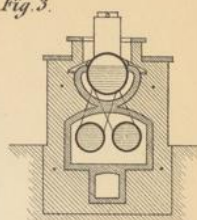

Fig. 4.

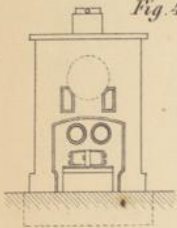

Fig. 5.

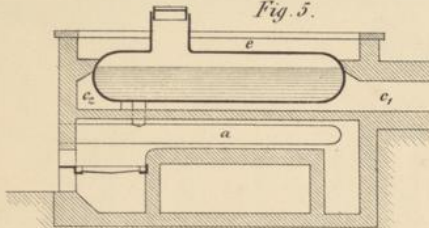

Fig. 6.

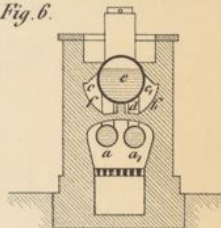

Fig. 8.

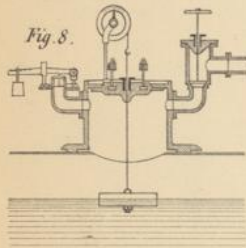

Fig. 7.

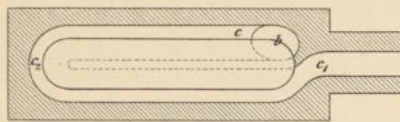

Fig. 9.

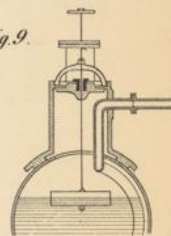

Fig. 10.

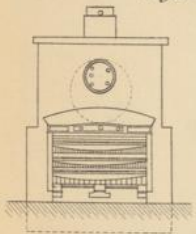

Fig. 11.

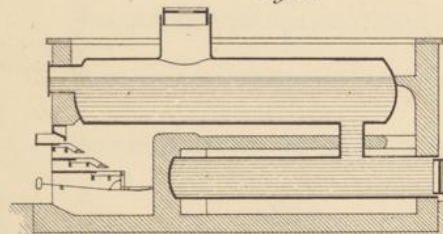

Fig. 12.

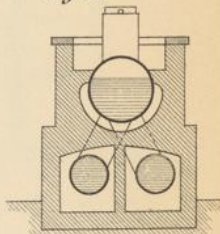

Fig. 13.

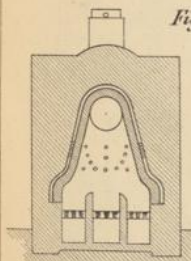

Fig. 14.

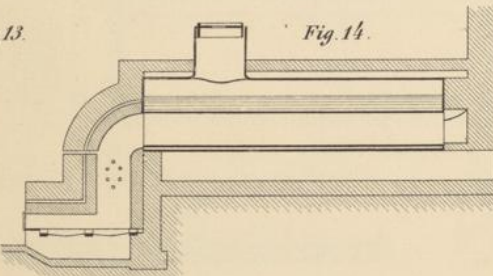
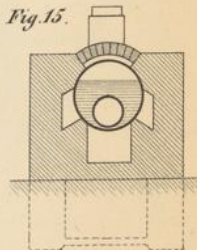
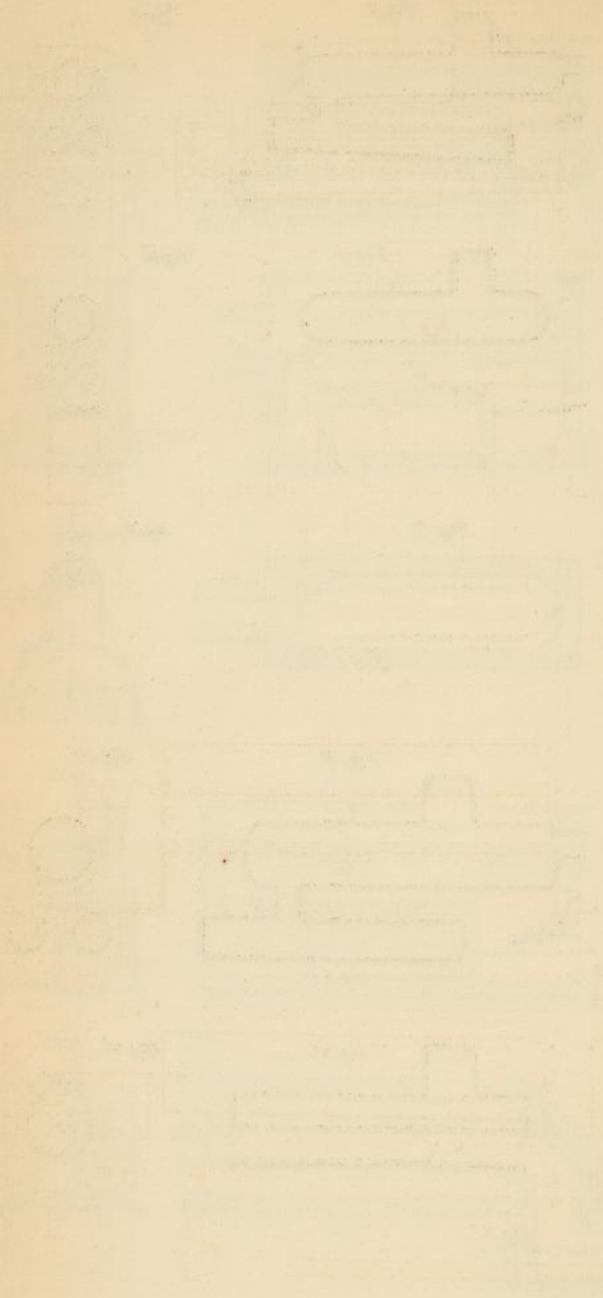

Fig. 15.



Lith. v. L. Geisenhöfer, Carlsruhe

1844



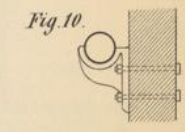
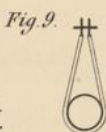
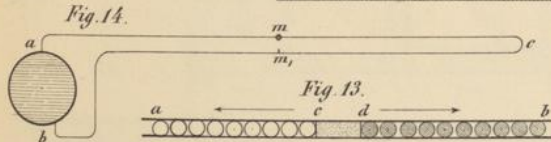
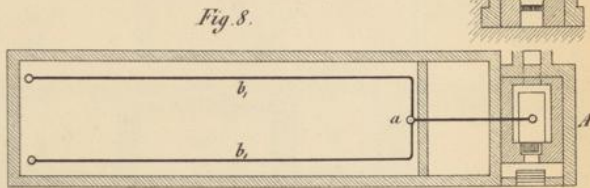
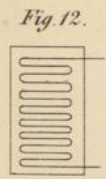
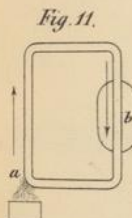
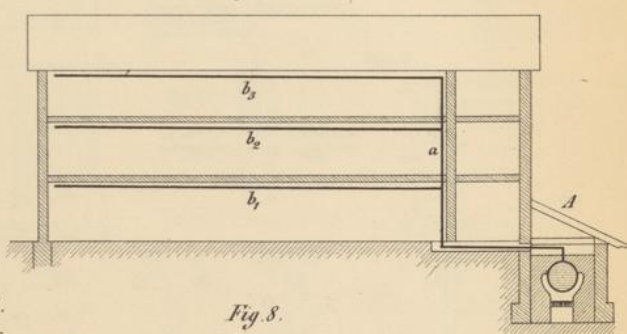
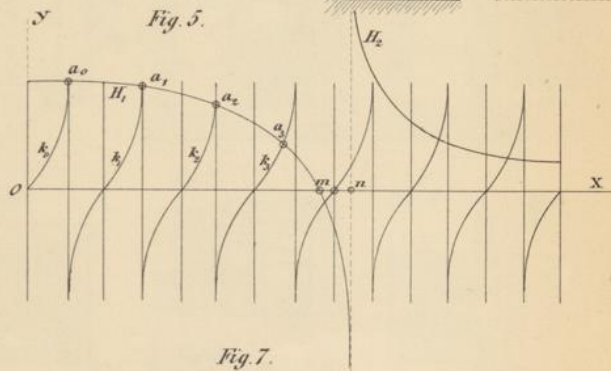
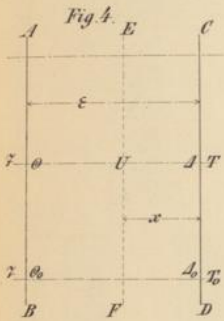
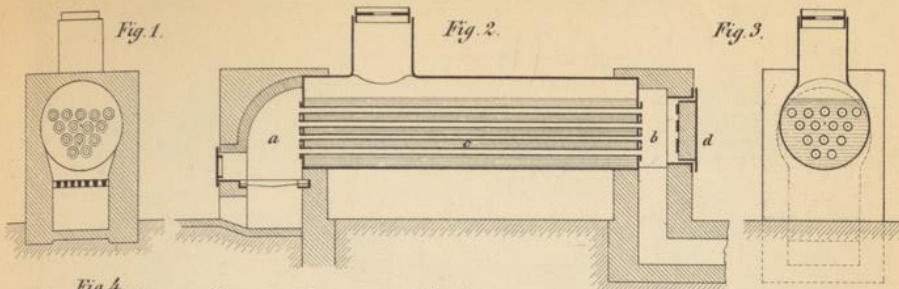

Lith. v. L. Weisendorfer, Karlsruhe

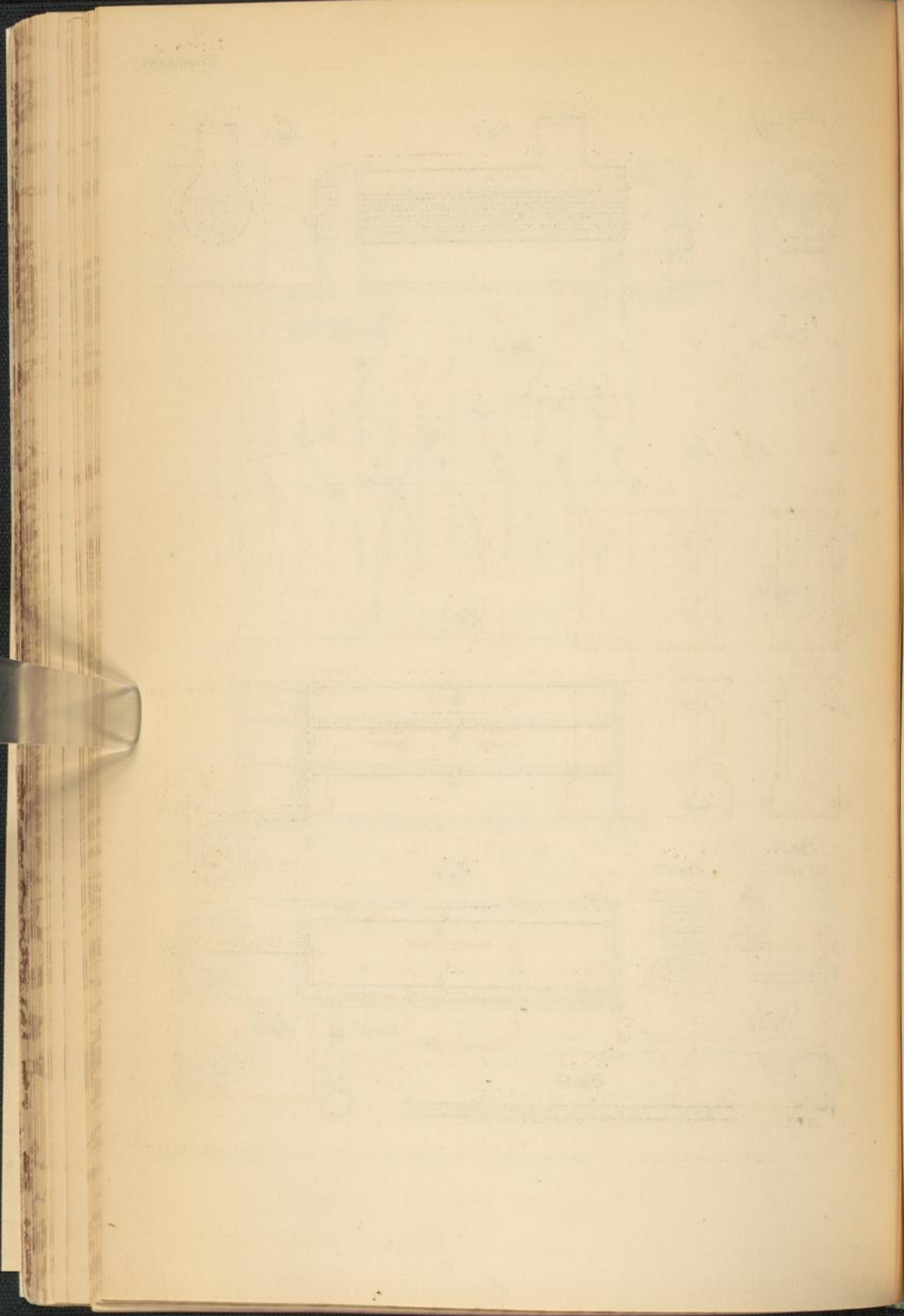

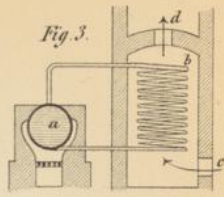
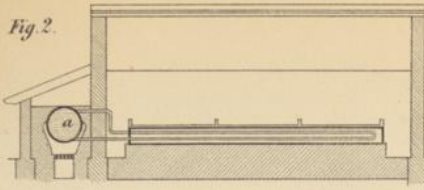
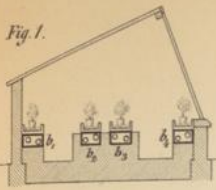

Fig. 4.

Fig. 5.

Fig. 8.

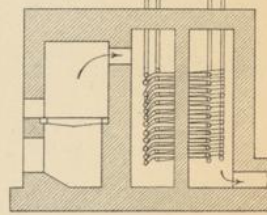
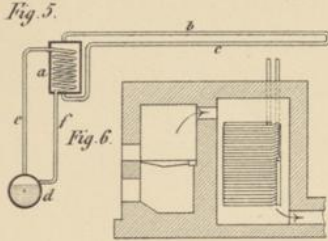
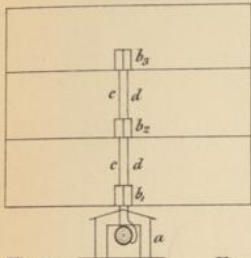

Fig. 11.

Fig. 12.

Fig. 7.

Fig. 9.

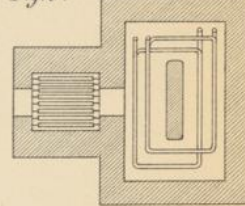
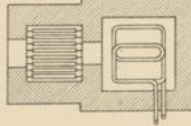
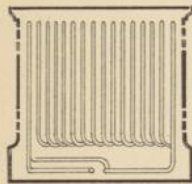
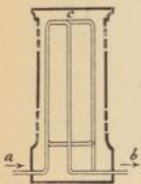

Fig. 13.

Fig. 14.

Fig. 10.

Fig. 16.

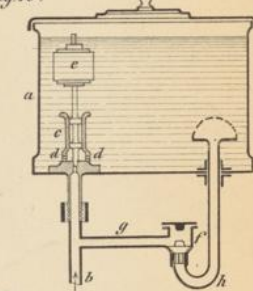
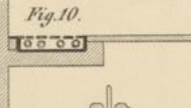
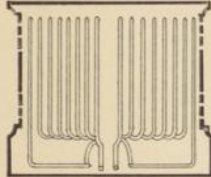
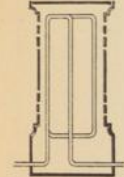

Fig. 17.

Fig. 18.

Fig. 19.

Fig. 20.

Fig. 21.

Fig. 22.

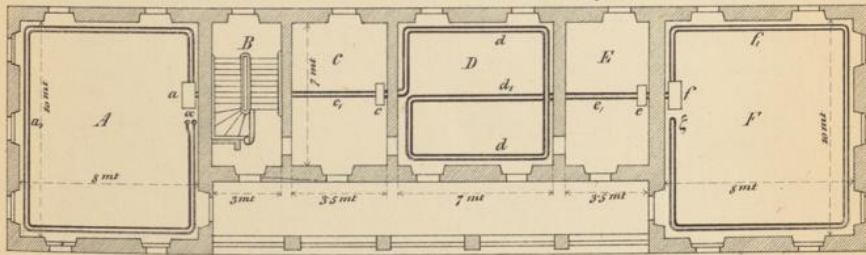



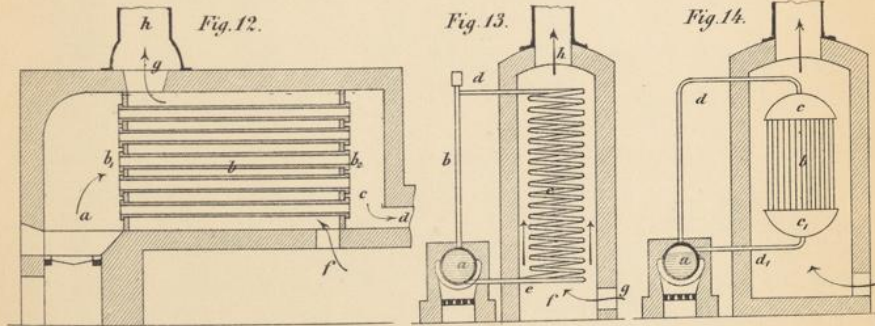
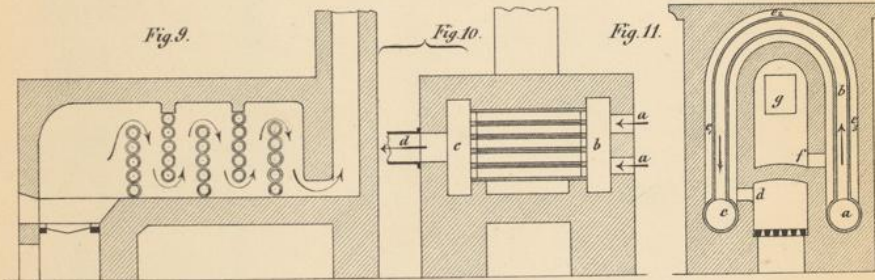
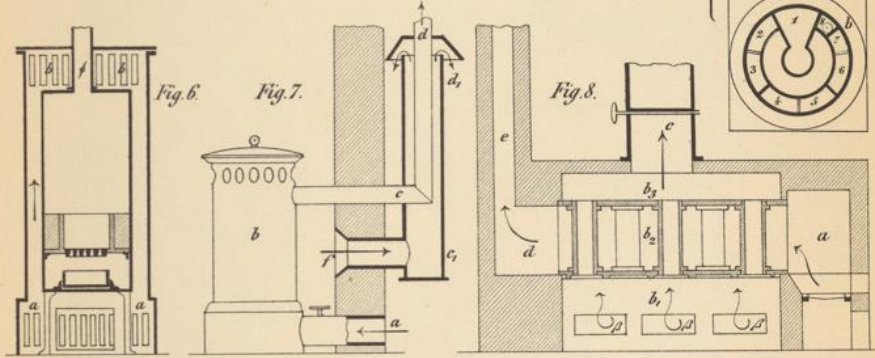
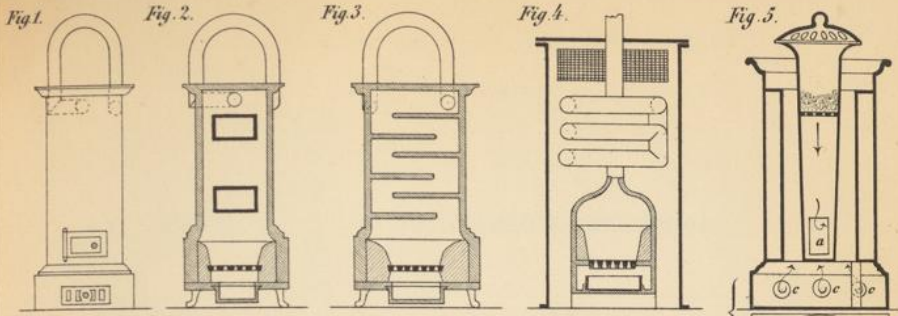

Lith. L. Weisenböcker, Carlshütte





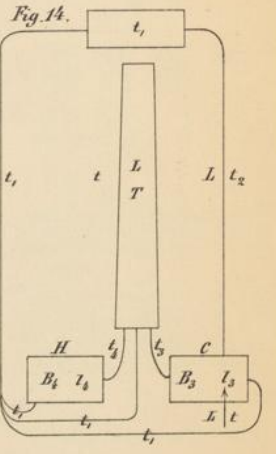
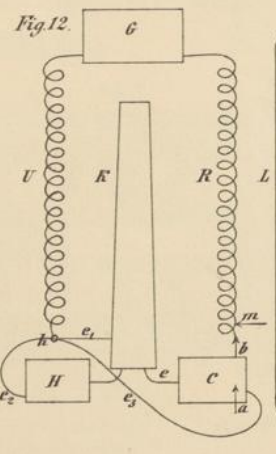
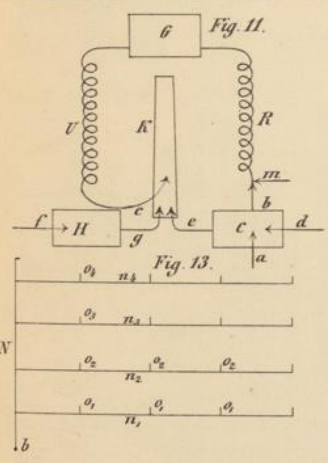
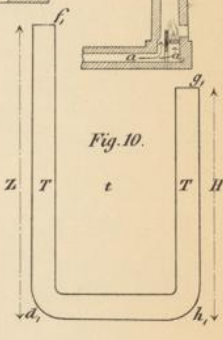
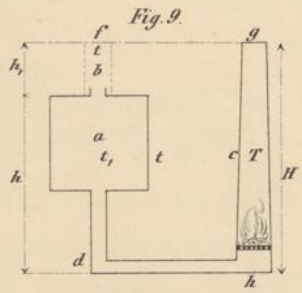
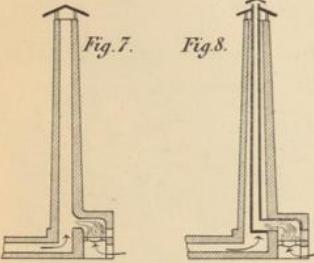
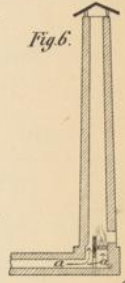
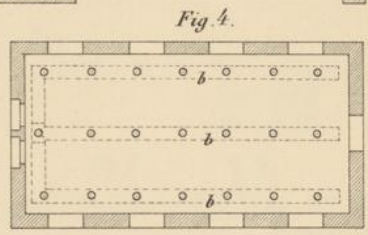
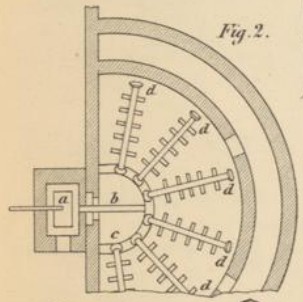
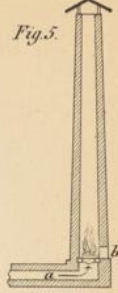
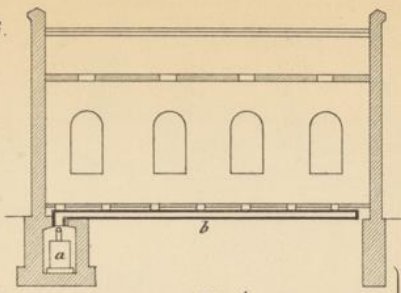
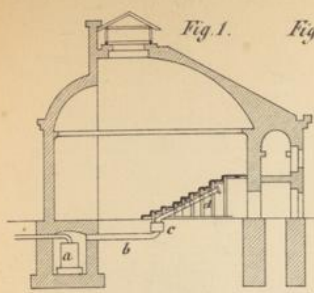

Lith. v. L. Geisendorfer, Carlsruhe



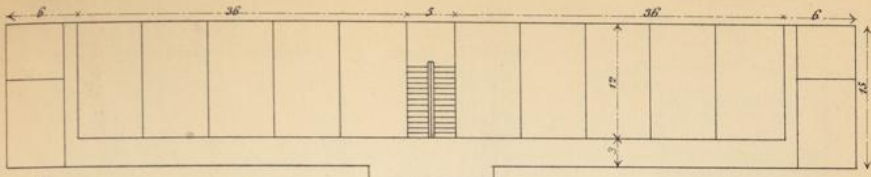

Fig. 1.

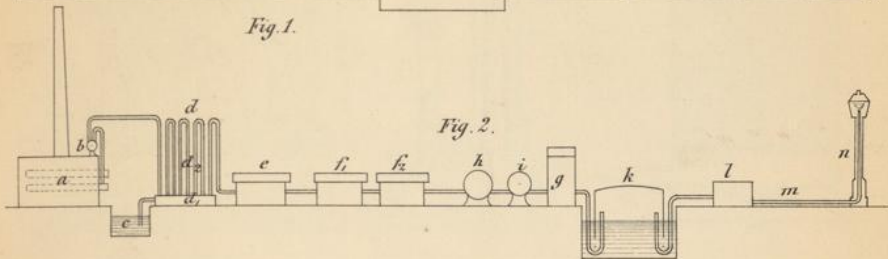

Fig. 2.

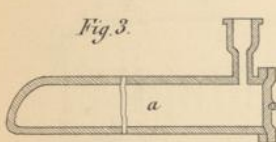

Fig. 3.

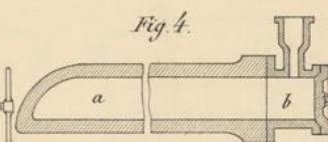

Fig. 4.

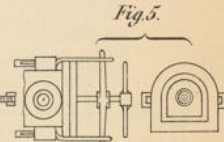

Fig. 5.

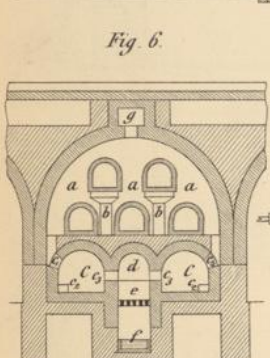

Fig. 6.

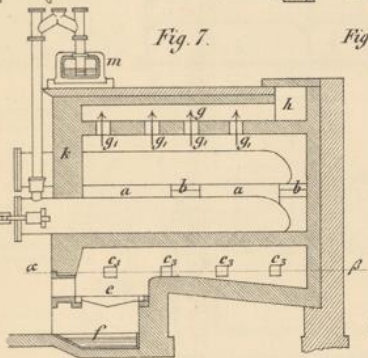

Fig. 7.

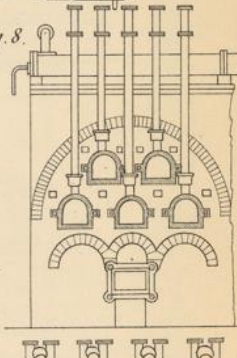

Fig. 8.

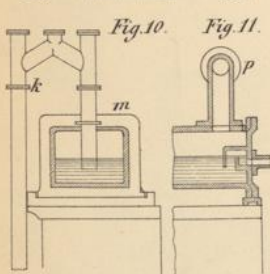

Fig. 10.

Fig. 11.

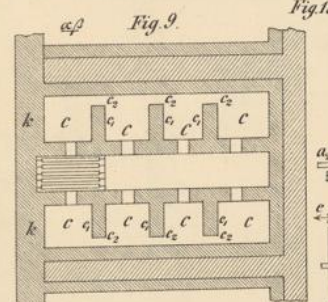

Fig. 9.

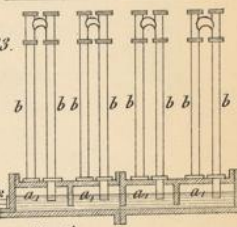

Fig. 13.

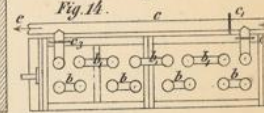

Fig. 14.

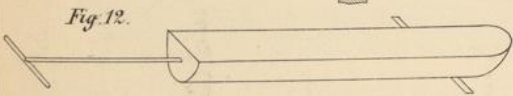

Fig. 12.

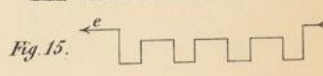
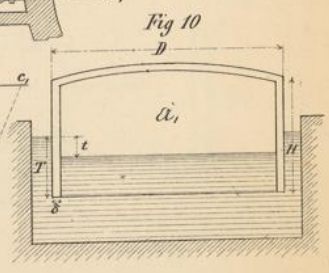
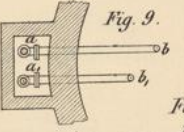
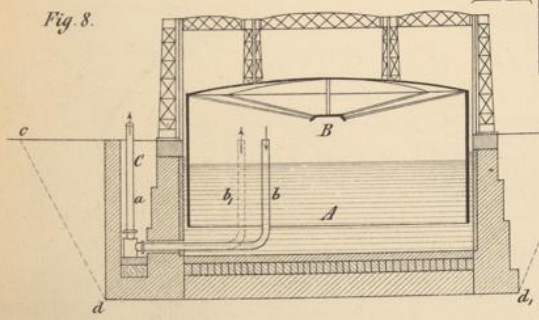
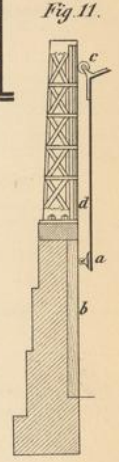
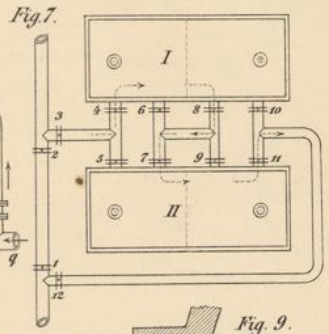
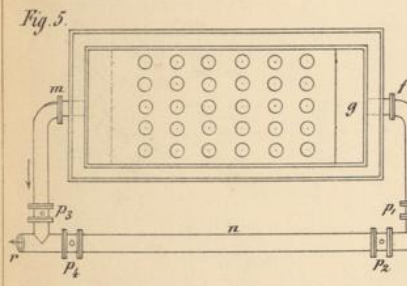
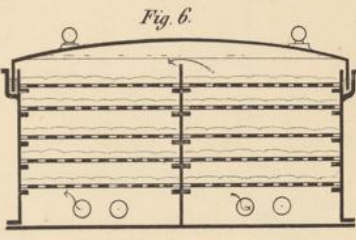
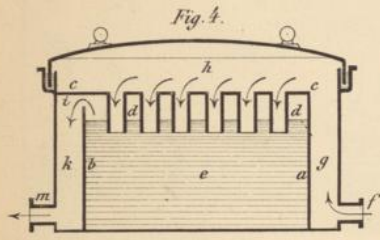
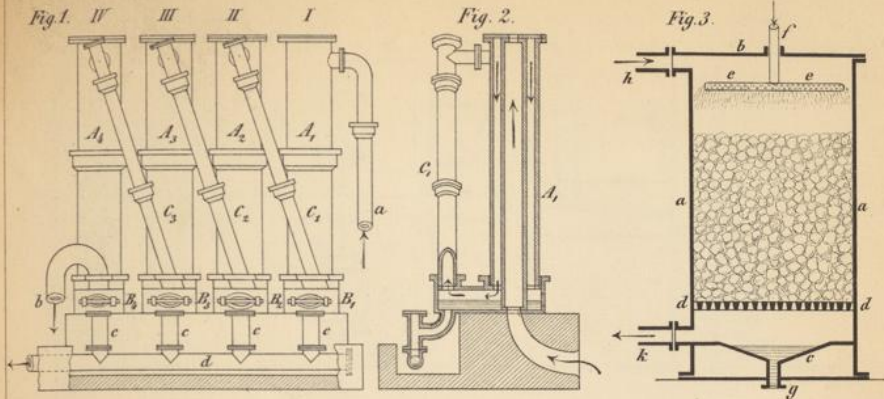

Fig. 15.





W. 111. 111.

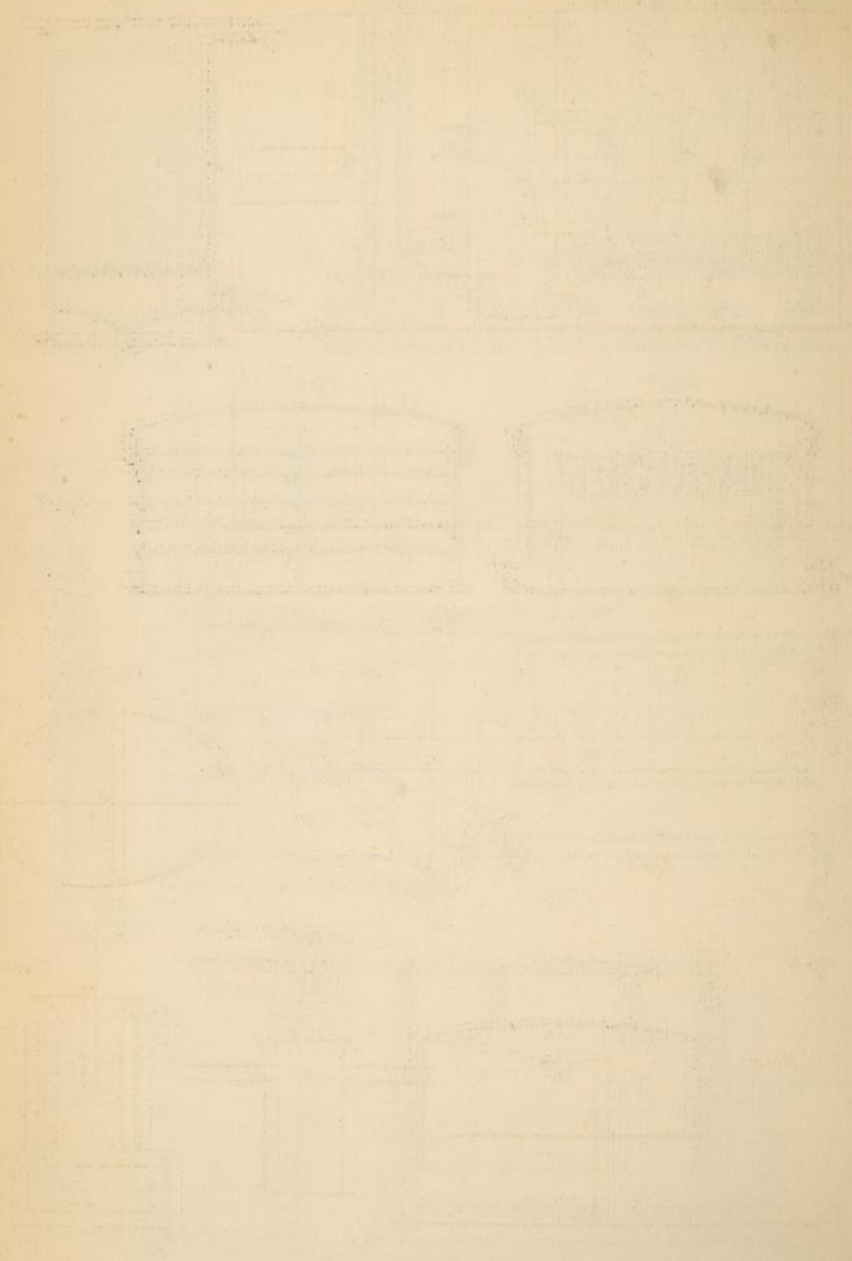

Fig. 1.

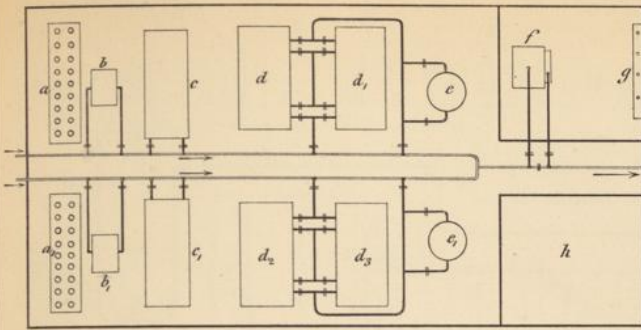

Fig. 2.

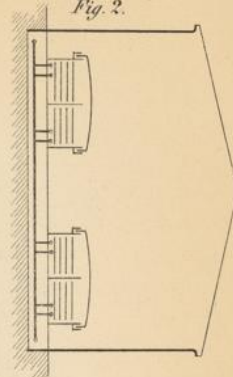

Fig. 3.

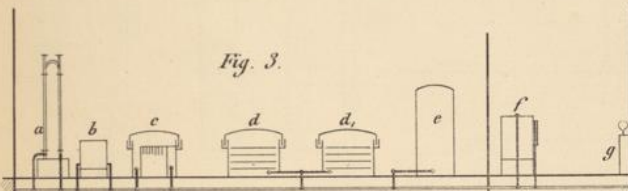

Fig. 4.

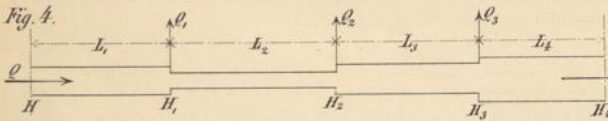

Fig. 5.

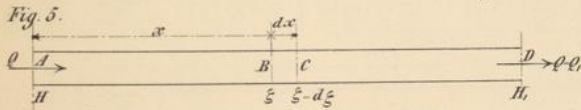

Fig. 6.

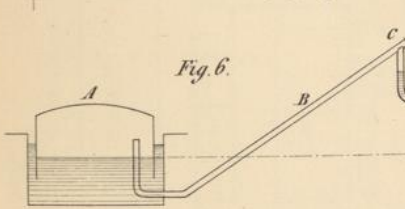

Fig. 8.

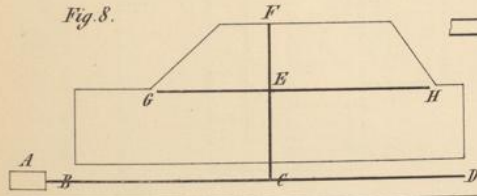

Fig. 9.

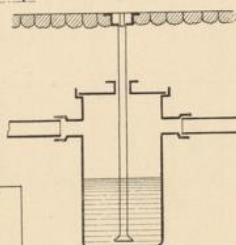
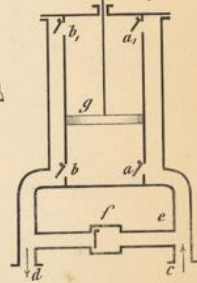

Fig. 10.



Lith. v. L. Gosenrörfer, Karlsruhe



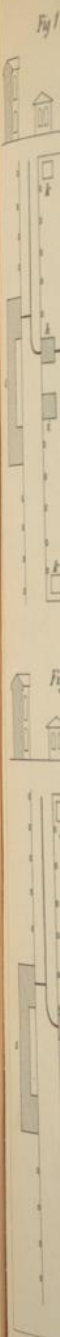
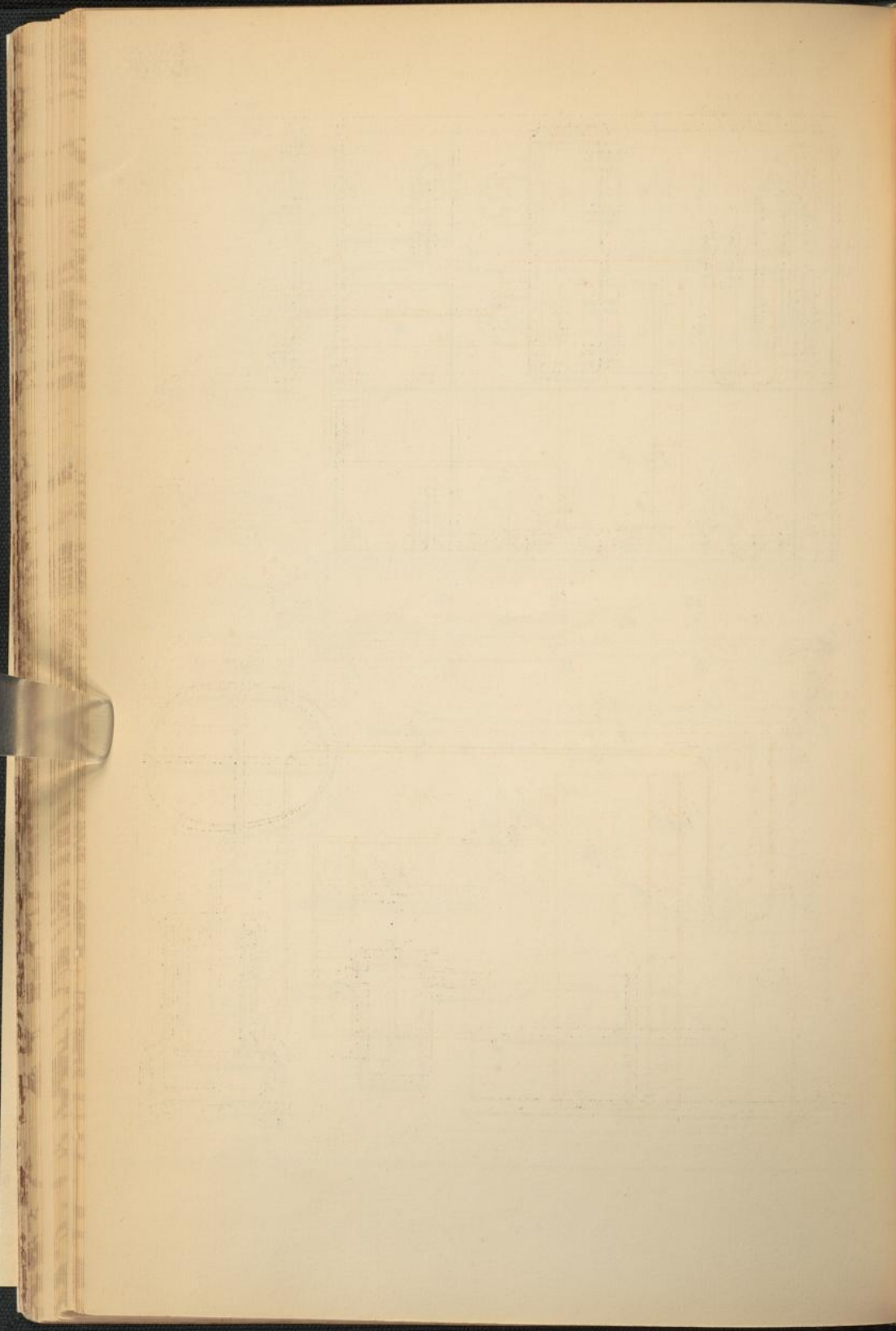

Fig 1.

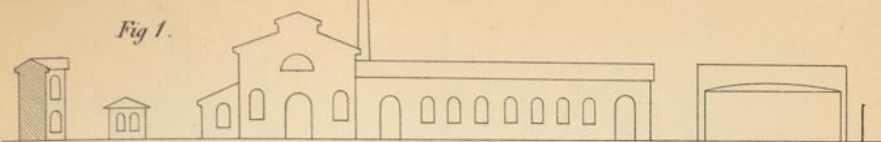

Fig. 2.

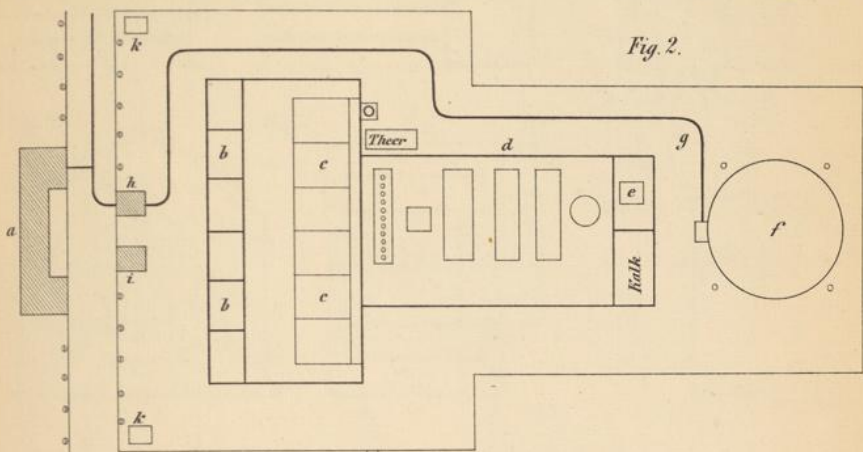

Fig. 3.

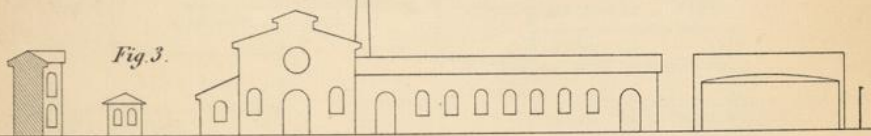
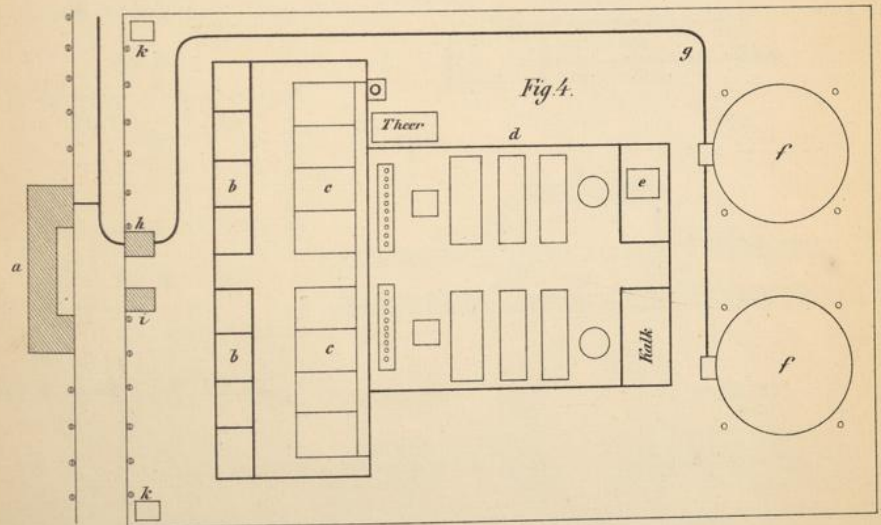
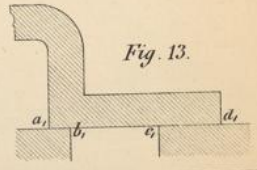
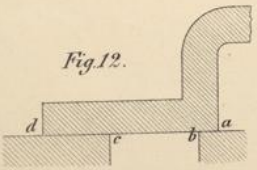
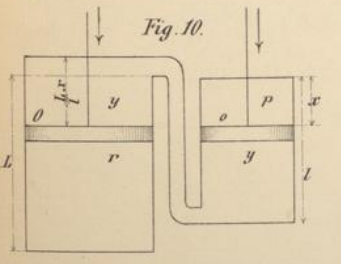
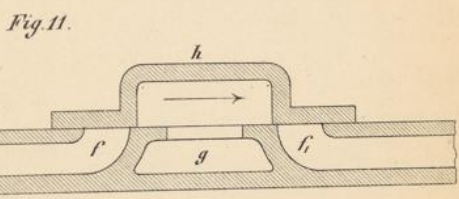
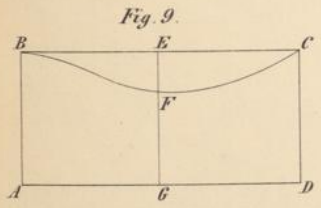
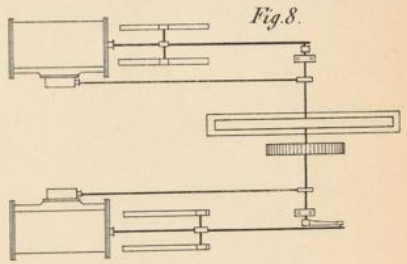
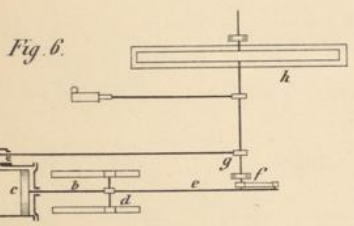
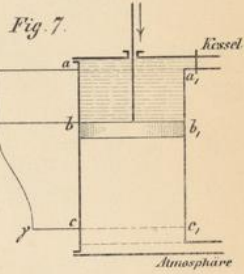
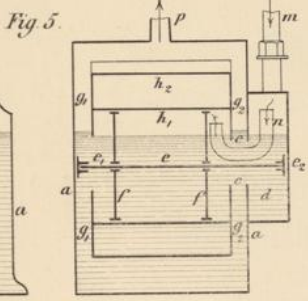
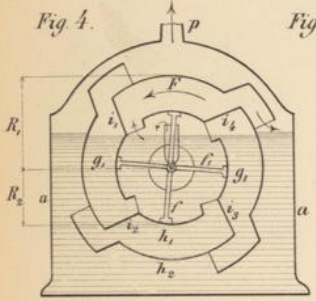
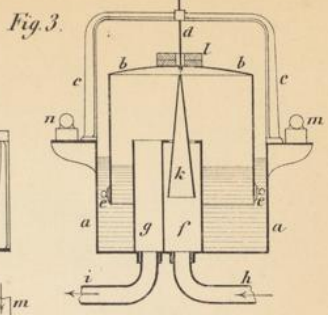
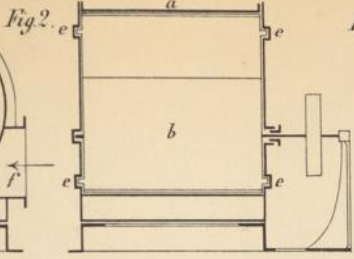
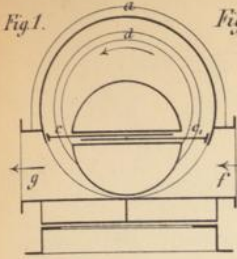

Fig. 4.



Lith. v. L. Geismendörfer, Carlsruhe





Ich v. L. Geisendörfer, Carlstadt



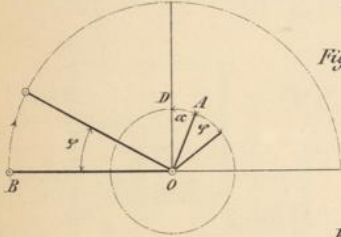
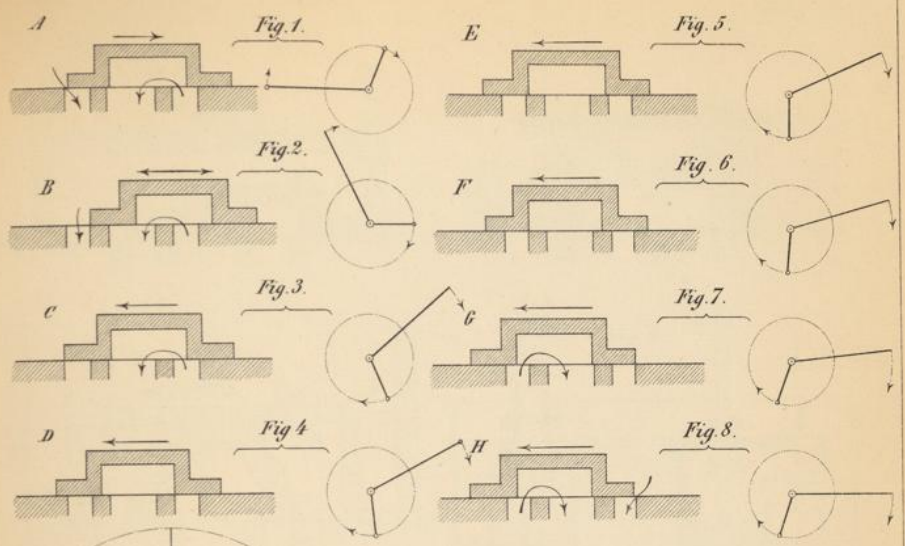

Fig. 9.

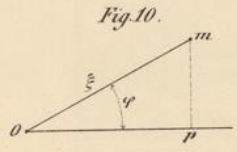

Fig. 10.

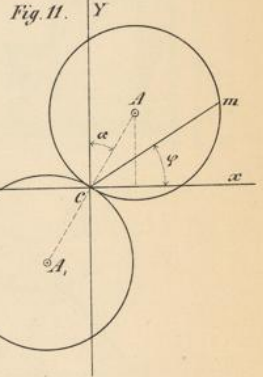

Fig. 11.

Fig. 12.

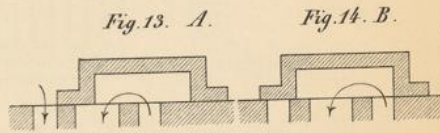
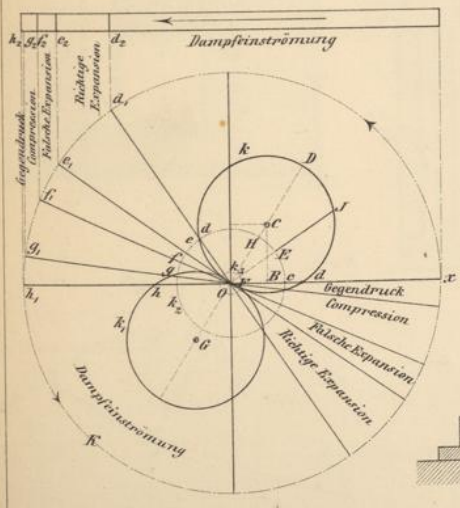

Fig. 13. A.

Fig. 14. B.

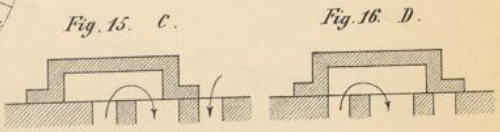

Fig. 15. C.

Fig. 16. D.



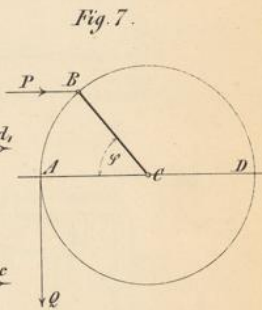
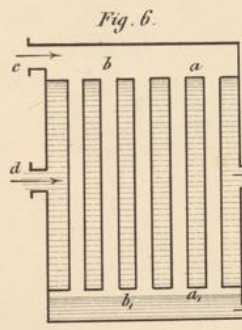
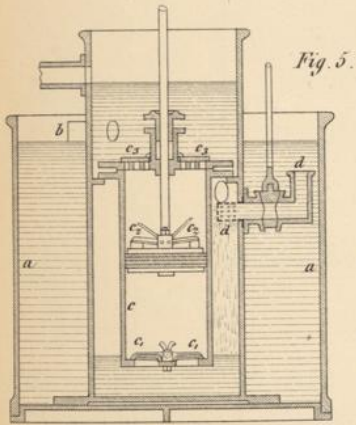
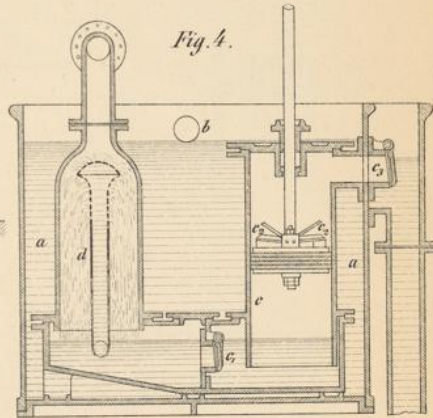
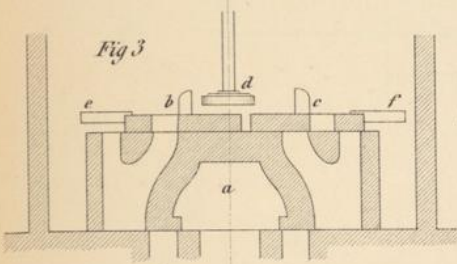
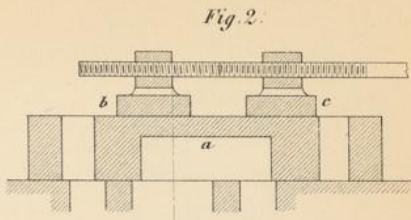
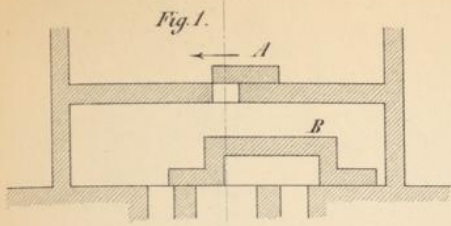

Fig. 8.

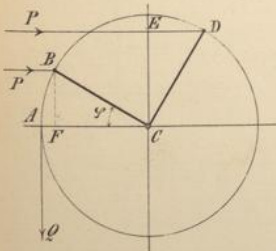
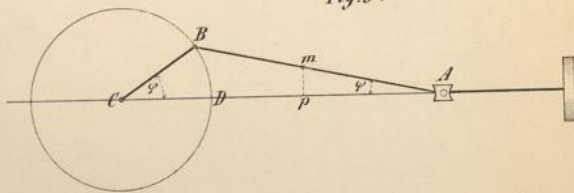

Fig. 9.



lith. v. L. Geisenhöfer, Carlsruhe





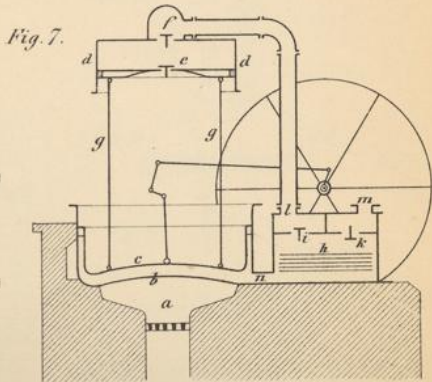
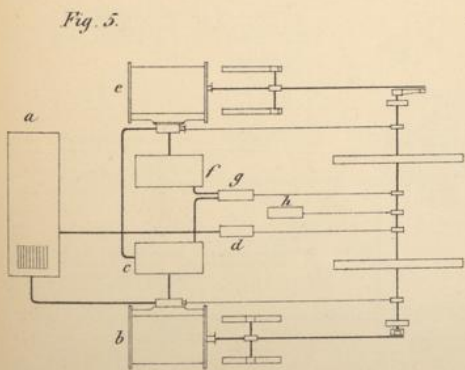
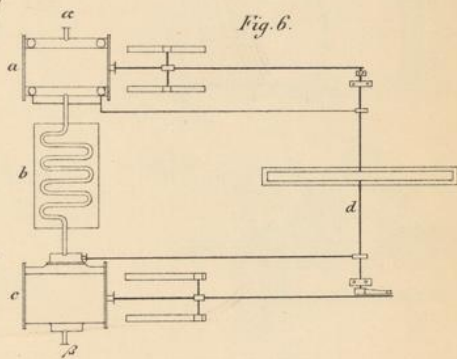
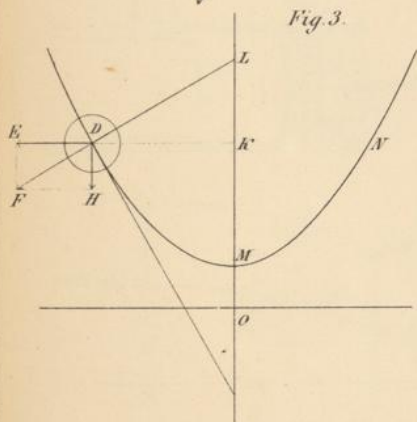
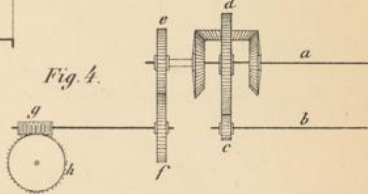
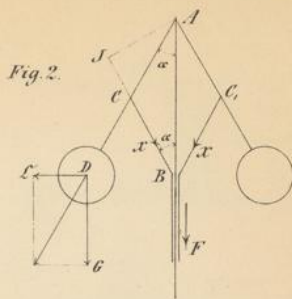
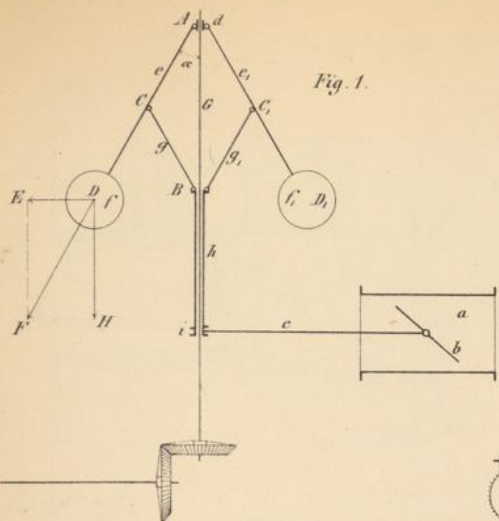

Lith. v. L. Geisendörfer, Carlsruhe.



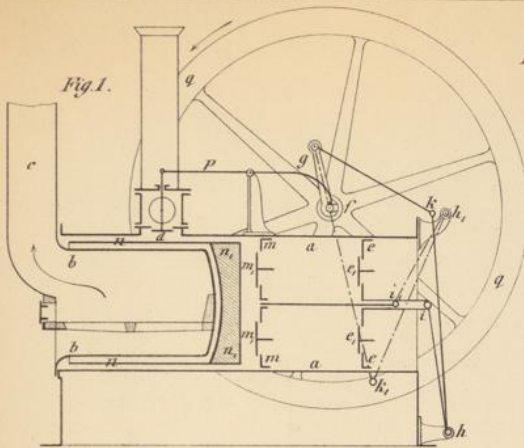

Fig. 2.

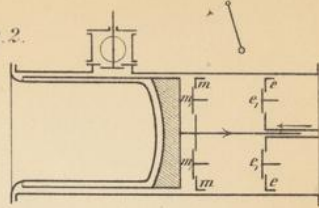

Fig. 3.

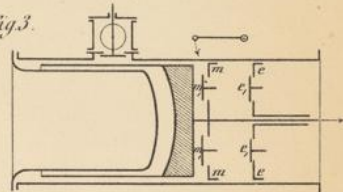

Fig. 4.

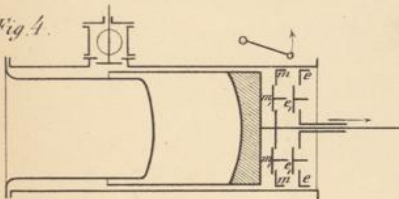

Fig. 5.

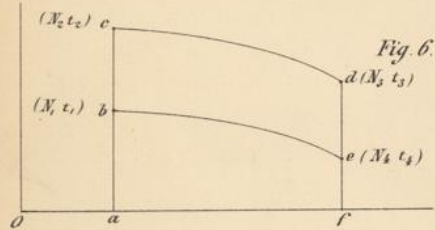
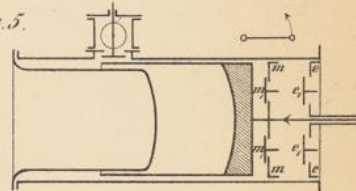

Fig. 6.

Fig. 8.

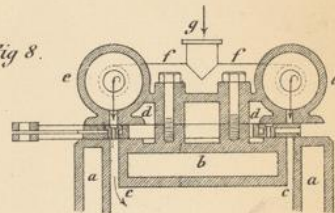

Fig. 9.

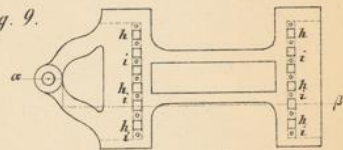

Fig. 10.

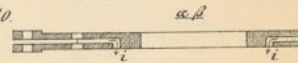
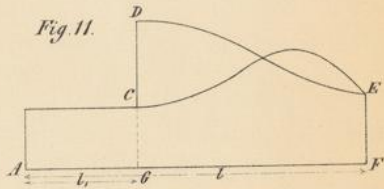

Fig. 11.



Lith. v. L. Weisenböcker, Carlsruhe

